

Surface Operation

Lighting the Burners
All burners are ignited by electric ignition. There are no open-flame, "standing" pilots.

VariSimmer™
Simmering is a cooking technique in which foods are cooked in hot liquids kept at or just barely below the boiling point of water. Simmering ensures gentler treatment than boiling to prevent food from toughening and/or breaking up. The size of the pan and the volume of food can have a significant effect on how high or low a flame is needed for simmering. For this reason, Viking range and rangetop burners are engineered with a VariSimmer setting. The VariSimmer setting is not just one simmer setting, but provides a variable range of simmer settings. This variable range of simmer settings allows you to adjust the flame height to achieve the best simmer depending on the type and quantity of food being simmered. It is this ability that makes the VariSimmer setting the most accurate and trustworthy simmer on the market.

TruPower Plus™ Burner (where applicable)
Certain model ranges are equipped with a TruPower Plus 18,500 BTU burner in the front right burner position. This burner is designed to provide extra high heat output, especially when using large pans, and should be used for boiling large quantities or if you need to bring something to a boil quickly. While TruPower Plus burner has the extra power needed to bring large quantities of liquid to a boil rapidly, it is also able to be turned down low enough to provide a very low and delicate simmer making this burner the most versatile on the market.

Griddle/Simmer Plate (where applicable)
The optional 15,000 BTU griddle is constructed of machined steel with a blanchard finish and is uniquely designed to offer excellent cooking performance as well as easy clean up. The griddle is equipped with an electronic thermostat to maintain an even temperature across the griddle once the desired temperature has been set. The griddle has a power "ON" indicator light which glows when the griddle thermostat has been turned on. This will cycle on and off as needed to indicate the thermostat is maintaining the selected temperature. Before the griddle is used, it is important to season the griddle. See instructions in the Use & Care for steps on seasoning the griddle.

Char-Grill (where applicable)
The optional 18,000 BTU char-grill is equipped with a single piece, heavy-duty porcelainized cast-iron grill grate for easy movement of grilling items. Beneath the

Setting the Clock

grill grate are two slotted porcelainized flavor generator plates which are designed to catch drippings and circulate a smoke flavor back into the food. Beneath the flavor generator plates is a two piece drip pan which catches any drippings that might pass beyond the flavor generator plates. This unique grilling system is designed to provide outdoor quality grilling indoors.

Clock Display (General)
When AC power is applied (including after a power loss), CLOCK display shows a flashing "12:00" and begins incremental time. Once set, clock is "ON" or "OFF" based on user's last setting.

To turn "ON": If time is off, any key press will turn on TIME display. When range is turned "ON" following the selection of FUNCTION or TEMPERATURE, TIME display turns "ON".

To turn "OFF": Turn the range "OFF". If TIME is on display, a second press of "OFF" button will turn off TIME display.

Programming Clock
(Clock defaults to 12:00 and flashes when first powered up or if power is interrupted.)
1. Press "CLOCK/PROBE" button. The clock display will flash.

2. Toggle "SELECTOR" right to increase or left to decrease to set desired time. Time will scroll in 1 minute increments per individual toggle. If "SELECTOR" is held in either right or left position, time will increase or decrease in 10 minute increments until desired time is reached. Clock automatically rolls from AM to PM.

3. Push in "SELECTOR" to accept time and start timer or after 5 seconds, time will auto-accept. (When clock is set and needs to be changed, press "CLOCK/PROBE" button and follow the two steps above. CLOCK display will flash when activated.)

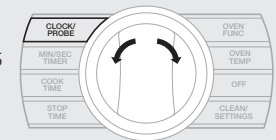

Oven Controls

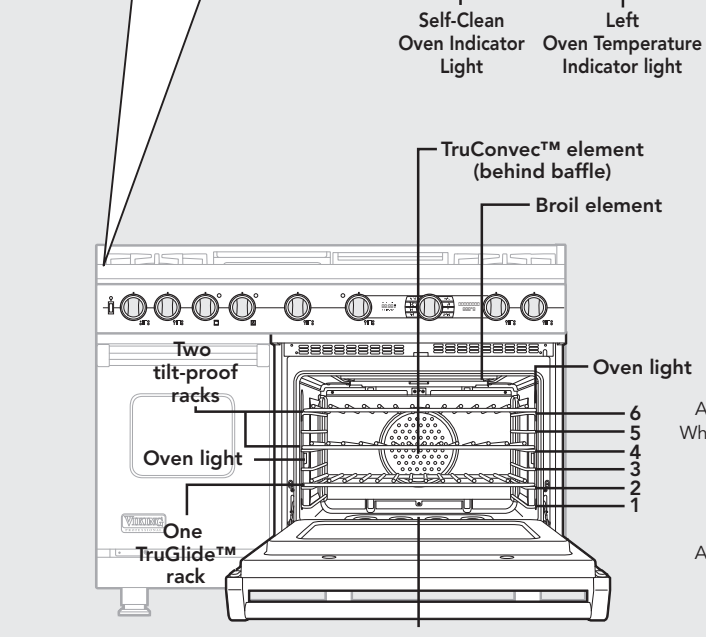
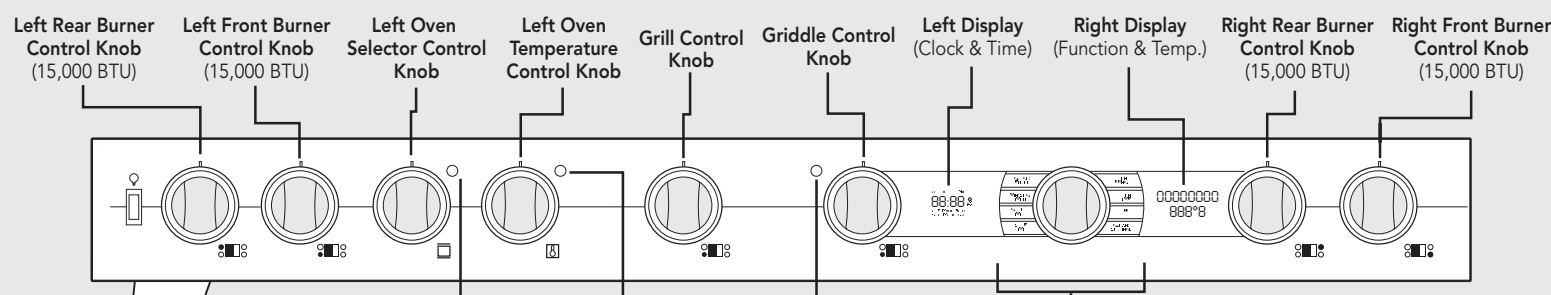

Note: VDSC548T4GQ model range shown here.

Griddle/Simmer Plate Operation/Settings

- Turn the griddle control knob to desired temperature setting.
- **ALWAYS** turn off when not in use, or lower the heat between cooking loads.

Grill Operation/Settings

- Turn on ventilator (separate product).
- Turn control knob to HI.
- Preheat on HI for 5 to 10 minutes.
- Place food on grill, cook as desired.

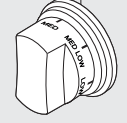
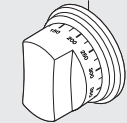

Right Oven Selector Controls

- Clock/Probe Button**
Allows clock to be set to desired time. When probe is connected, use this button to set desired temperature
- Min/Sec Timer Button**
Allows timer to be set to desired time.
- Cook Time Button**
Set a specific amount of time and a specific cooking function to be performed.
- Stop Time Button**
Set a delay bake time, giving an amount of time before baking begins and an amount of time for the duration of baking.
- Oven Function Button**
Set the appropriate oven function including: Bake, Convection Bake, TruConvex™, Broil, Convection Broil, Convection Roast, Auto Roast, Defrost, Dehydrate, Proof, and Self-Clean.
- Oven Temp Button**
Allows appropriate oven temperature to be set.
- Off Button***
First press turns oven off. Second press turns off time display. Activates Control Lock if pressed in conjunction with Clear/Settings button.
- Clear/Settings Button***
Press Clear to acknowledge an expired timer. Press Clear to cancel a function. When setting a function, time etc., press the Clear key to revert to previous setting.

***Note:** These keys have added importance.

Oven Functions and Settings

BAKE (Two-Element Bake)

Full power heat is radiated from the bake element in the bottom of the oven cavity and supplemental heat is radiated from the broil element. This function is recommended for single rack baking. Many cookbooks contain recipes to be cooked in the conventional manner. Conventional baking/roasting is particularly suitable for dishes that require a high temperature. Use this setting for baking, roasting, and casseroles.

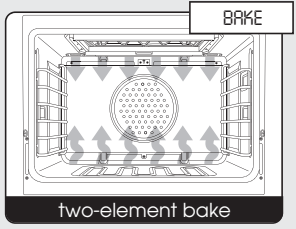

CONV BAKE (Convection Bake)

The bottom element operates at full power, and the top broil element operates at supplemental power. The heated air is circulated by the motorized fan in the rear of the oven providing a more even heat distribution. This even circulation of air equalizes the temperature throughout the oven cavity and eliminates the hot and cold spots found in conventional ovens. A major benefit of convection baking is the ability to prepare food in quantity using multiple racks—a feature not possible in a standard oven.

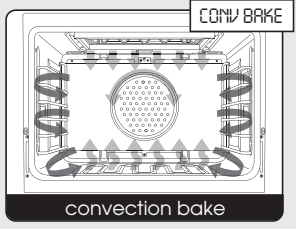

TRU CONV (TruConvex™)

The rear element only operates at full power. There is no direct heat from the bottom or top elements. The motorized fan in the rear of the oven circulates air in the oven cavity for even heating. Use this setting for foods that require gentle cooking such as pastries, souffles, yeast breads, quick breads and cakes. Breads, cookies, and other baked goods come out evenly textured with golden crusts. No special bakeware is required. Use this function for single rack baking, multiple rack baking, roasting, and preparation of complete meals. This setting is also recommended when baking large quantities of baked goods at one time.

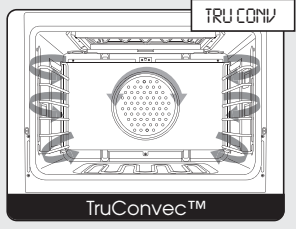

CONV ROAST (Convection Roast)

The convection element runs in conjunction with the inner and outer broil elements. The reversible convection fan runs at a higher speed in each direction. This transfer of heat (mainly from the convection element) seals moisture inside of large roasts. A time savings is gained over existing, single fan convection roast modes. Use this setting for whole turkeys, whole chickens, hams, etc.

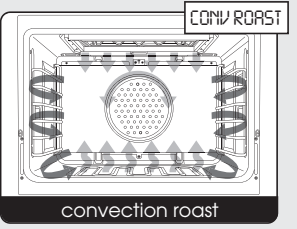

AUTO ROAST (Auto Roast)

Use this function to simplify roasting by automatically searing the outside of roasts. When Set Auto Roast Temperature is reached, one long beep will sound and the display will show "SEARING." The oven will remain at searing temperature (set temperature plus 100°F) for 30 minutes. If set, Cook Time timer will begin.

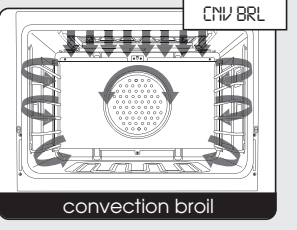

CONV BROIL (Convection Broil)

The top element operates at full power. This function is exactly the same as regular broiling with the additional benefit of air circulation by the motorized fan in the rear of the oven. Smoke is reduced since the airflow also reduces peak temperatures on the food. Use this setting for broiling thick cuts of meats.

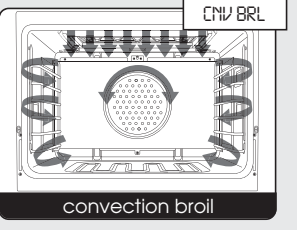

HI BROIL

Heat radiates from both broil elements, located in the top of the oven cavity, at full power. The distance between the foods and the broil elements determines broiling speed. For fast broiling, food may be as close as 2 inches (5 cm) to the broil element or on the top rack. Fast broiling is best for meats where rare to medium doneness is desired. Use this setting for broiling small and average cuts of meat.

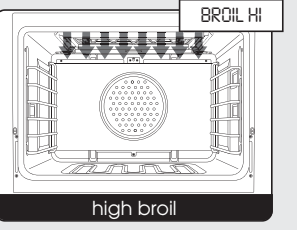

MED BROIL

Inner and outer broil elements pulse on and off to produce less heat for slow broiling. Allow about 4 inches (10 cm) between the top surface of the food and the broil element. Slow broiling is best for chicken and ham in order to broil without over-browning it. Use this setting for broiling small and average cuts of meat.

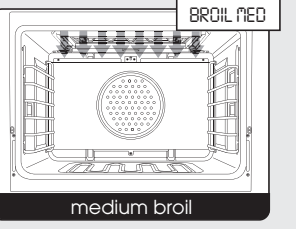

LOW BROIL

This mode uses only a fraction of the available power to the inner broil element for delicate top-browning. The inner broil element is on for only part of the time. Use this setting to gently brown meringue on racks 3 or 4 in 3-4 minutes.

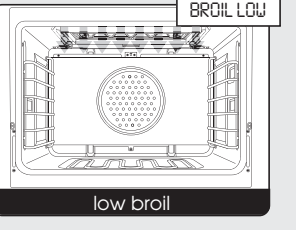

DEHYDRATE (Convection Dehydrate)

This oven is designed not only to cook, but also to dehydrate fruits and vegetables by removing water

DEFROST (Convection Defrost)

Use this function to defrost foods.

PROOF

Use this setting to allow yeast dough to rise. Temperature can be set between 90° and 110°F (32° to 44°C).

SELF CLEAN

Use this function to clean oven.

Warnings

Warning and Important Safety Instructions appearing in this manual are not meant to cover all possible conditions and situations that may occur. Common sense, caution, and care must be exercised when installing, maintaining, or operating the appliance.

ALWAYS contact the manufacturer about problems or conditions you do not understand.

Recognize Safety Symbols, Words, Labels

⚠ DANGER
Hazards or unsafe practices which WILL result in severe personal injury or death

⚠ WARNING
Hazards or unsafe practices which COULD result in death severe personal injury or death

⚠ CAUTION
Hazards or unsafe practices which COULD result in minor personal injury.
All safety messages will identify the hazard, tell you how to reduce the chance of injury, and tell you what can happen if the instructions are not followed.

Read and follow all instructions before using this appliance to prevent the potential risk of fire, electric shock, personal injury or damage to the appliance as a result of improper usage of the appliance. Use appliance only for its intended purpose as described in this manual.

To ensure proper and safe operation: Appliance must be properly installed and grounded by a qualified technician. DO NOT attempt to adjust, repair, service, or replace any part of your appliance unless it is specifically recommended in this manual. All other servicing should be referred to a qualified servicer. Have the installer show you the location of the gas shutoff valve and how to shut it off in an emergency.

To prevent possible damage to cabinets and cabinet finishes, use only materials and finishes that will not discolor or delaminate and will withstand temperatures up to 194° F (90° C). Heat and moisture resistant adhesive must be used if the product is to be installed in laminated cabinetry. Check with your builder or cabinet supplier to make sure that the materials meet these requirements.

A GFI shall be used if required by NFPA-70 (National Electric Code), federal/state/local laws, or local ordinances.

- The required use of a GFI is normally related to the location of a receptacle with respect to any significant sources of water or moisture.
- Viking Range Corporation will NOT warranty any problems resulting from GFI outlets which are not installed properly or do not meet the requirements below.

If the use of a GFI is required, it should be:

- Of the receptacle type (breaker type or portable type NOT recommended)
- Used with permanent wiring only (temporary or portable wiring NOT recommended)
- On a dedicated circuit (no other receptacles, switches, or loads in the circuit)
- Connected to a standard breaker of appropriate size (GFI breaker of the same size NOT recommended)
- Rated for Class A (5 mA +/- 1 mA trip current) as per UL 943 standard
- In good condition and free from any loose-fitting gaskets (if applicable in outdoor situations)
- Protected from moisture (water, steam, high humidity) as much as reasonably possible

Important Safety Notice and Warning

The California Safe Drinking Water and Toxic Enforcement Act of 1986 (Proposition 65) requires the Governor of California to publish a list of substances known to the State of California to cause cancer or reproductive harm, and requires businesses to warn customers of potential exposures to such substances. Users of this appliance are hereby warned that when the oven is engaged in the self-clean cycle, there may be some low-level exposure to some of the listed substances, including carbon monoxide. Exposure to these substances can be minimized by properly venting the oven to the outdoors by opening the windows and/or door in the room where the appliance is located during the self-clean cycle.

Important notice regarding pet birds:

NEVER keep pet birds in the kitchen or in rooms where the fumes from the kitchen could reach. Birds have a very sensitive respiratory system. Fumes released during an oven self-cleaning cycle may be harmful or fatal to birds. Fumes released due to overheated cooking oil, fat, margarine and overheated non-stick cookware may be equally harmful.

Warnings (cont.)

About Your Appliance

⚠ WARNING
NEVER use appliance as a space heater to heat or warm a room to prevent potential hazard to the user and damage to the appliance. Also, DO NOT use the rangetop or oven as a storage area for food or cooking utensils.

- Avoid touching oven vent area while oven is on and for several minutes after oven is turned off. When the oven is in use, the vent and surrounding area become hot enough to cause burns. After oven is turned off, DO NOT touch the oven vent or surrounding areas until they have had sufficient time to cool.
- The misuse of oven doors (e.g. stepping, sitting, or leaning on them) can result in potential hazards and/or injuries.
- The appliance must be installed and electrically grounded according to local codes. Have the installer identify the location and shut-off valve on the oven so you know where and how to turn off gas if necessary.

⚠ WARNING
This range features a self-cleaning cycle. During this cycle, the oven reaches elevated temperatures in order to burn off soil and deposits. A powder ash residue is left in the bottom of the oven after completion of the self-clean cycle.
Note: DO NOT use commercial oven cleaners inside the oven. Use of these cleaners can produce hazardous fumes or can damage the porcelain finishes. DO NOT line the oven with aluminum foil or other materials. These items can melt or burn during a self-clean cycle, causing permanent damage to the oven.

⚠ WARNING
To avoid risk of property damage, personal injury or death; follow information in this manual exactly to prevent a fire or explosion. DO NOT store or use gasoline or other flammable vapors and liquids in the vicinity of this or any appliance.

⚠ WARNING
If the information in this manual is not followed exactly, a fire or explosion may result causing property damage, personal injury or death.

WHAT TO DO IF YOU SMELL GAS:

- DO NOT try to light any appliance.
- DO NOT touch any electrical switch.
- DO NOT use any phone in your building.
- Immediately call your gas supplier from a neighbor's phone. Follow the gas supplier's instructions.
- If you cannot reach your gas supplier, call the fire department.

Installation and service must be performed by a qualified installer, service agency or the gas supplier.

⚠ WARNING
TIPPING HAZARD
To reduce the risk of the appliance tipping, it must be secured by a properly installed anti-tip bracket(s). To make sure the bracket has been installed properly, look behind the range with a flashlight to verify proper installation engaged in the rear top left corner of the range.

- THIS RANGE CAN TIP
- INJURIES TO PERSONS CAN RESULT
- INSTALL ANTI-TIP DEVICE PACKED WITH RANGE
- SEE INSTALLATION INSTRUCTIONS

⚠ WARNING
DO NOT use commercial oven cleaners inside the oven. Use of these cleaners can produce hazardous fumes or can damage the porcelain finishes.

⚠ WARNING
ELECTRICAL SHOCK HAZARD
Disconnect the electric power at the main fuse or circuit breaker before replacing bulb.

Warnings (cont.)

⚠ WARNING
To avoid risk of property damage, personal injury or death; follow information in this manual exactly to prevent a fire or explosion. DO NOT store or use gasoline or other flammable vapors and liquids in the vicinity of this or any appliance.

⚠ WARNING
ELECTRICAL SHOCK HAZARD
DO NOT touch a hot oven light bulb with a damp cloth as the bulb could break. Should the bulb break, disconnect power to the appliance before removing bulb to avoid electrical shock.

⚠ WARNING
BURN OR ELECTRICAL SHOCK HAZARD
Make sure all controls are OFF and oven is COOL before cleaning. Failure to do so can result in burns or electrical shock.

⚠ CAUTION
BURN HAZARD
The oven door, especially the glass, can get hot. **Danger of burning: DO NOT touch the glass!**

⚠ CAUTION
BURN HAZARD
When self-cleaning, surfaces may get hotter than usual. Therefore, children should be kept away.

⚠ CAUTION
DO NOT touch the exterior portions of the oven after self-cleaning cycle has begun, since some parts become extremely hot to the touch!

During the first few times the self-cleaning feature is used, there may be some odor and smoking from the "curing" of the binder in the high-density insulation used in the oven. When the insulation is thoroughly cured, this odor will disappear. During subsequent self-cleaning cycles, you may sense an odor characteristic of high temperatures.

KEEP THE KITCHEN WELL-VENTED DURING THE SELF-CLEAN CYCLE.

⚠ NOTICE
DO NOT turn the Temperature Control on during defrosting. Turning the convection fan on will accelerate the natural defrosting of the food without the heat.

⚠ NOTICE
Avoid any damage to oven vents. The vents need to be unobstructed and open to provide proper airflow for optimal oven performance.

⚠ NOTICE
The Cooling Fan should be operating when the unit is in operation. If you notice the cooling fan is not operating or you observe unusual or excessive noise coming from the cooling fan, contact a Viking Authorized Service Center before continuing operation. Failure to do so can result in damage to the oven or surrounding cabinets.

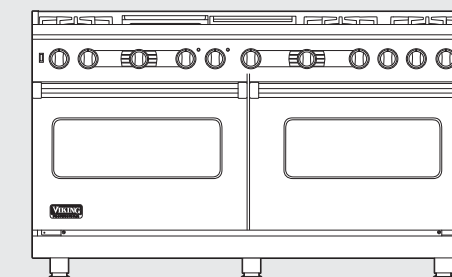
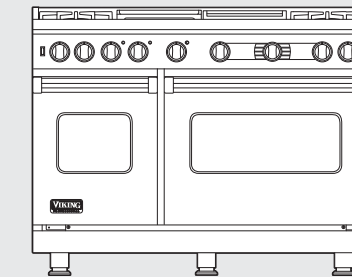
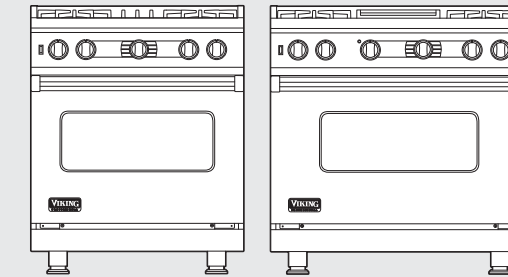

Viking Quick Reference Guide

Professional Freestanding Electronic Control Dual Fuel Ranges