

Owner's Manual

Advantium®
120V Speedcook Oven

For Models:

ZSC1000

ZSC1001

ZSC1201

ZSC1202

49-40736
MFL38211634

01-15 GE

monogram.com



MFL38211634

Introduction

Your new Monogram Advantium 120V Oven makes an eloquent statement of style, convenience and kitchen planning flexibility. Whether you chose it for its purity of design, assiduous attention to detail—or for both of these reasons—you'll find that your Monogram ovens's superior blend of form and function will delight you for years to come.

Your Monogram oven was designed to provide the flexibility to blend in with your kitchen cabinetry. Its sleek design can be beautifully integrated into the kitchen.

The information on the following pages will help you operate and maintain your oven properly.

If you have any questions, visit our Website at: monogram.com

Contents

Advantium

Advantium Quick Start 15
 Cooking controls 18
 Oven features 17
 Safety 4–15
 What is Advantium? 16

Speedcooking

Convection Baking, Broiling
 and Toasting 28
 Cooking tips 22
 Favorite recipes 25, 26
 Power level 23
 Proofing 29
 Repeat last 22
 Resume feature 22
 Speedcook cookware 24
 Speedcook menu guide 18
 Speedcook-safe cookware 8, 9
 Things that are normal 27
 Using a preset speedcook menu 21
 Warming 29

Microwaving

Cooking by time 31
 Cooking tips 31
 Defrost by food type 32
 Defrost by time 32
 Defrosting tips 33
 Express 17, 31
 Favorite recipes 31
 Microwave power level(s) 31
 Microwave-safe cookware 10, 11

Precautions to avoid possible
 exposure to excessive

microwave energy 4, 5
 Sensor cooking 34, 35
 Things that are normal 35
 Using preset microwave selections 30

Other Features

Automatic fan 38
 Beeper volume 36
 Child lockout 38
 Clock 17, 36
 Delay Start 36
 Display ON/OFF 36
 Help 37
 Reminder 36
 Review 36
 Scroll speed 36
 Timer 38

Care and Cleaning

Cleaning the inside 39
 Cleaning the outside 40
 Cooking trays and baking sheet 40
 Removable turntable 39

Troubleshooting

Problem Solver 41, 42

Customer Service

Service phone numbers 43
 Warranty Back Cover

Consumer Information

Advantium Oven

Before using your oven

Read this manual carefully. It is intended to help you operate and maintain your new oven properly.

Keep it handy for answers to your questions.

If you don't understand something or need more help, there is a list of toll-free consumer service numbers included in the back section of this manual.

OR

Visit our Website at: monogram.com

Write down the model & serial numbers

You'll find them on a label under the oven.

Fill out and return the Consumer Product Registration Card that is packed with this product.

Before sending in the card, please write the numbers here:

Model Number

Serial Number

Use these numbers in any correspondence or service calls concerning your cooktop.

If you received a damaged oven

Immediately contact the dealer (or builder) that sold you the oven.

Save time & money

Read this manual. Inside you will find many helpful hints on how to use and maintain your oven properly. Just a little preventive care on your part can save you a great deal of time and money over the life of your oven.

You'll find many answers to common problems in the Before You Call for Service section. If you review our chart of Troubleshooting Tips first, you may not need to call for service at all.

If you need service

To obtain service, see the Consumer Services page in the back of this manual.

We're proud of our service and want you to be pleased. If for some reason you are not happy with the service you receive, here are some steps to follow for further help.

FIRST, contact the people who serviced your appliance. Explain why you are not pleased. In most cases, this will solve the problem.

NEXT, if you are still not pleased, write all the details—including your phone number—to:

Manager, Customer Relations
GE Appliances
Appliance Park
Louisville, KY 40225

IMPORTANT SAFETY INSTRUCTIONS

Advantium Oven

PRECAUTIONS TO AVOID POSSIBLE EXPOSURE TO EXCESSIVE MICROWAVE ENERGY

- (a) ***Do Not Attempt*** to operate this oven with the door open since open-door operation can result in harmful exposure to microwave energy. It is important not to defeat or tamper with the safety interlocks.
- (b) ***Do Not Place*** any object between the oven front face and the door or allow soil or cleaner residue to accumulate on sealing surfaces.
- (c) ***Do Not Operate*** the oven if it is damaged. It is particularly important that the oven door close properly and that there is no damage to the:
 - (1) door (bent),
 - (2) hinges and latches (broken or loosened),
 - (3) door seals and sealing surfaces.
- (d) ***The Oven Should Not*** be adjusted or repaired by anyone except properly qualified service personnel.

When using electrical appliances, basic precautions should be followed, including the following:

⚠ WARNING! *To reduce the risk of burns, electric shock, fire, injury to persons, or exposure to excessive microwave energy:*

SAFETY PRECAUTIONS

- Read all instructions before using this appliance.
- Read and follow the specific precautions in the PRECAUTIONS TO AVOID POSSIBLE EXPOSURE TO EXCESSIVE MICROWAVE ENERGY section above.
- This appliance must be grounded. Connect only to properly grounded outlet. See "GROUNDING INSTRUCTIONS" found on page 12.
- Install or locate this appliance only in accordance with the provided installation instructions.
- Some products such as whole eggs and sealed containers—for example, closed jars—are able to explode and should not be heated in this oven. Such use of the oven could result in injury.
- Do not mount this appliance over a sink.
- This oven is not approved or tested for marine use.
- This oven is UL listed for standard wall installation.
- Do not operate this appliance if it has a damaged power cord or plug, if it is not working properly, or if it has been damaged or dropped.
- As with any appliance, close supervision is necessary when used by children.
- Use this appliance only for its intended use as described in this manual.
- Do not use corrosive chemicals or vapors in this appliance.
- This oven is specifically designed to heat, dry or cook food, and is not intended for laboratory or industrial use.
- Do not store anything directly on top of the microwave oven surface when the microwave oven is in operation.
- This appliance must only be serviced by qualified service personnel. Contact nearest authorized service facility for examination, repair or adjustment.
- Do not cover or block any openings on the appliance.
- Do not store this appliance outdoors. Do not use this product near water—for example, in a wet basement, near a swimming pool, near a sink or in similar locations.
- See door surface cleaning instructions in the *Care and Cleaning of the Oven* section of this manual.
- To reduce the risk of fire in the oven cavity:
 - Do not overcook food. Carefully attend appliance when paper, plastic or other combustible materials are placed inside the oven while microwave cooking.
 - Remove wire twist-ties and metal handles from paper or plastic containers before placing them in the oven.
 - Do not use the oven for storage purposes. Do not leave paper products, cooking utensils or food in the oven when not in use.
 - If materials inside the oven ignite, keep the oven door closed, turn the oven off and shut off power at the fuse or circuit breaker panel. If the door is opened, the fire may spread.
 - Do not use the Sensor Features twice in succession on the same food portion. If food is undercooked after the first countdown, use COOK BY TIME for additional cooking time.

SAVE THESE INSTRUCTIONS

INSTRUCCIONES DE SEGURIDAD IMPORTANTES

Horno Advantium

PRECAUCIONES PARA EVITAR LA POSIBLE EXPOSICIÓN A ENERGÍA DE MICROONDAS EXCESIVA

- (a) **No intente hacer** funcionar el horno con la compuerta abierta ya que ésto puede provocar exposición peligrosa a la energía de microondas. Es importante no forzar ni dañar los seguros.
- (b) **No coloque** ningún objeto entre la parte frontal del horno y la compuerta, ni permita que se acumulen residuos de producto limpiador o detergente, suciedad o polvo en las superficies de sellado.
- (c) **No haga funcionar** el horno si se encuentra dañado. Es particularmente importante cerrar bien la compuerta del horno y que no haya daños en:
- (1) la compuerta (doblada o curvada),
 - (2) las bisagras y pestillos (rotos o flojos),
 - (3) sellos de la compuerta y superficies de sellado.
- (d) **El horno no debe** ser ajustado o reparado por ninguna persona, excepto por personal de mantenimiento calificado.

Al utilizar aparatos eléctricos, se deben seguir precauciones básicas de seguridad, incluyendo las siguientes:

⚠ ¡ADVERTENCIA! *Para reducir el riesgo de quemaduras, descargas eléctricas, incendio, lesiones o exposición a energía de microondas excesiva:*

PRECAUCIONES DE SEGURIDAD

- Lea todas las instrucciones antes de utilizar este aparato.
- Lea y obedezca las precauciones específicas en la sección de PRECAUCIONES PARA EVITAR POSIBLE EXPOSICIÓN A UNA ENERGÍA EXCESIVA DE MICROONDAS de arriba.
- Este electrodoméstico debe estar conectado a tierra. Conéctelo sólo a una toma de corriente con toma de tierra. Vea la sección de INSTRUCCIONES DE TOMA DE TIERRA en la página 13.
- Instale o ubique este aparato únicamente de acuerdo a las instrucciones de instalación suministradas.
- Algunos productos tales como huevos enteros y contenedores sellados (por ejemplo, frascos sellados) son propensos a explotar y no deben calentarse en este horno. Tal uso del horno puede resultar en lesiones personales.
- No monte este aparato sobre el fregadero.
- Este horno no ha sido aprobado ni probado para utilización marina.
- Este horno está listado por UL para a instalación de pared estándar.
- No usar este electrodoméstico si el cable de corriente o el enchufe han sufrido algún daño, si no funciona correctamente o si ha resultado dañado o se ha caído.
- Como con cualquier aparato, cuando sea utilizado por niños es necesaria una estrecha vigilancia.
- Utilice este aparato solamente para el fin previsto, como se describe en este manual.
- No utilice químicos ni vapores corrosivos en este aparato.
- Este horno está específicamente diseñado para calentar, secar o cocinar alimentos y bebidas y no está diseñado para usarse en un laboratorio ni para uso industrial.
- No almacene ningún elemento directamente sobre la superficie del horno de microondas cuando éste se encuentre en funcionamiento.
- Sólo personal cualificado debe reparar este aparato. Póngase en contacto con el centro de mantenimiento autorizado más cercano en caso de necesitar revisión, reparación o ajuste.
- No cubra ni bloquee ninguna apertura de este aparato.
- No almacene este aparato al aire libre. No utilice este producto cerca del agua; por ejemplo, en un sótano húmedo, cerca de una piscina, cerca de un lavabo o lugares similares.
- Consulte las instrucciones de limpieza de la superficie de la puerta en la sección de *Mantenimiento y limpieza del horno* de este manual.
- Para reducir el riesgo de incendio dentro del horno:
 - No cocine excesivamente los alimentos. Vigile cuidadosamente el aparato cuando se coloque papel, plástico u otros materiales combustibles dentro del microondas mientras se cocina.
 - Quite las tiritas de seguridad (twist-ties) y asas metálicas de los recipientes de papel o plástico antes de colocarlos dentro del microondas.
 - No utilice el horno para propósitos de almacenamiento. No deje productos de papel, utensilios de cocina ni comestibles dentro del horno cuando no se utilicen.
 - Si los materiales que se encuentran dentro del horno prenden fuego, mantenga la compuerta del microondas cerrada, apague el horno y corte el suministro eléctrico a nivel del fusible o del panel de interruptores de su hogar. Puede propagar el fuego si abre la compuerta del microondas.
 - No utilice las funciones del sensor dos veces sucesivamente en la misma porción de alimento. Si el alimento no se cocina completamente después del primer conteo regresivo, utilice la función COOK BY TIME (COCINAR POR TIEMPO) para permitir tiempo de cocción adicional.

GUARDE ESTAS INSTRUCCIONES

IMPORTANT SAFETY INSTRUCTIONS

Advantium Oven

▲ WARNING!

SAFETY PRECAUTIONS

- Do not operate the oven without the turntable in place. The turntable must be unrestricted so it can turn.
- During and after use, do not touch, or let clothing or other flammable materials contact any interior area of the oven; allow sufficient time for cooling first.
- Keep the oven free from grease buildup.
- Cook meat and poultry thoroughly—meat to at least an INTERNAL temperature of 160°F, and poultry to at least an INTERNAL temperature of 180°F. Cooking to these temperatures usually protects against foodborne illness.
- Potentially hot surfaces include the oven door, floor, walls, oven rack and turntable.

ARCING

Arcing can occur during both speedcooking and microwave cooking. If you see arcing, press the CANCEL/OFF pad and correct the problem.

Arcing is the microwave term for sparks in the oven. Arcing is caused by:

- Metal or foil touching the side of the oven.
- Foil not molded to food (upturned edges act like antennas).
- Use foil only as recommended in this manual.
- Metal cookware used during either speedcook or microwave cooking (except for the pans provided with the oven).
- Metal, such as twist-ties, poultry pins, or gold-rimmed dishes, in the oven.
- Recycled paper towels containing small metal pieces being used in the oven.

FOODS

- When microwaving, place all foods and containers on the clear glass tray.
- Do not pop popcorn in your oven unless in a special microwave popcorn accessory or unless you use popcorn labeled for use in microwave ovens.
- Do not boil eggs in this oven. Pressure will build up inside egg yolk and will cause it to burst, possibly resulting in injury.
- Do not operate the oven without food inside. This may cause damage to the oven. It increases the heat around the magnetron and can shorten the life of the oven.
- Foods with unbroken outer “skin” such as potatoes, hot dogs, sausages, tomatoes, apples, chicken livers and other giblets, and egg yolks should be pierced to allow steam to escape during cooking.
- **SUPERHEATED WATER**
Liquids, such as water, coffee or tea, are able to be overheated beyond the boiling point without appearing to be boiling. Visible bubbling or boiling when the container is removed from the microwave oven is not always present. THIS COULD RESULT IN VERY HOT LIQUIDS SUDDENLY BOILING OVER WHEN THE CONTAINER IS DISTURBED OR A SPOON OR OTHER UTENSIL IS INSERTED INTO THE LIQUID.
To reduce the risk of injury to persons:
 - Do not overheat the liquid.
 - Stir the liquid both before and halfway through heating it.
 - Do not use straight-sided containers with narrow necks.
 - After heating, allow the container to stand in the microwave oven for a short time before removing the container.
 - Use extreme care when inserting a spoon or other utensil into the container.

SAVE THESE INSTRUCTIONS

INSTRUCCIONES DE SEGURIDAD IMPORTANTES

Horno Advantium

⚠ ¡ADVERTENCIA!

PRECAUCIONES DE SEGURIDAD

- No haga funcionar el horno sin tener colocada en su lugar la base giratoria. La base giratoria debe estar libre de bloqueos para poder girar.
- Durante y después de utilizarlo, no toque ni permita que la ropa u otros materiales inflamables entren en contacto con ningún área interior del horno; primero deje que se enfríe.
- Mantenga el horno libre de acumulación de grasa.
- Cocine a fondo la carne de res o ave la carne de res a por los menos una temperatura INTERNA de 160° F y carne de ave a por lo menos una temperatura INTERNA de 180° F. Cocinar a estas temperaturas generalmente protege contra enfermedades causadas por los alimentos.
- Entre las superficies potencialmente calientes se incluye la compuerta, base, paredes, parrilla y base giratoria del horno.

ARQUEO VOLTAICO

El arqueo voltaico puede ocurrir tanto durante la cocción rápida (speedcooking) y de microondas. Si nota que ocurre arqueo voltaico, apriete el botón táctil CANCEL/OFF (BORRAR/APAGAR) y corrija el problema.

El arqueo voltaico es el término técnico que define las chispas en el horno. El arqueo voltaico es causado por:

- Metal o lámina de metal en contacto con el costado del horno.
- Lámina de metal moldeada al alimento (los bordes doblados hacia arriba actúan como antenas).
- Utilice la lámina de metal según las recomendaciones de este manual.
- Utensilios de cocina de metal utilizados durante la cocción rápida o de microondas (excepto ollas suministradas con el horno).
- Metal, tal como tiras metálicas de seguridad, sujetadores para carne de ave o platos con borde de oro en el horno.
- Toallas de papel reciclado que contengan pedazos de metal pequeños que se utilizan en el horno.

ALIMENTOS

- Cuando utilice el microondas, coloque todos los alimentos y contenedores en la bandeja de vidrio transparente.
- No cocine palomitas de maíz en el horno a menos que se coloquen en un accesorio de palomitas de maíz para microondas especial o a menos que utilice palomitas de maíz aptas para hornos de microondas.
- No hierva huevos en este horno. Se acumulará presión dentro de la yema del huevo y causará que explote, posiblemente causando lesiones.
- No ponga a funcionar el horno sin alimentos en el interior. Esto podría dañar el horno. Aumenta el calor alrededor del magnetrón y puede acortar la vida útil del microondas.
- Alimentos con la cáscara no cortada, como papas, salchichas, embutidos, tomates, manzanas, hígado de pollo y otras menudencias y yemas de huevo deben perforarse para permitir que el vapor escape durante la cocción.
- **AGUA SOBRECALENTADA**
Líquidos, tales como agua, café o té, son capaces de sobrecalentarse más allá del punto de ebullición sin parecer que estén hirviendo. No siempre hay burbujeo o hervor visible cuando se saca el recipiente del horno microondas. ESTO PUEDE RESULTAR EN LA EBULLICIÓN REPENTINA DE LÍQUIDOS MUY CALIENTES CUANDO SE MUEVE EL RECIPIENTE O SE INSERTA UNA CUCHARA U OTRO UTENSILIO DENTRO DEL LÍQUIDO.
Para reducir el riesgo de lesión física:
 - No sobrecaliente el líquido.
 - Revuelva el líquido antes y a la mitad del tiempo de calentamiento.
 - No utilice recipientes con costados rectos y cuellos angostos.
 - Después de calentar el recipiente, déjelo en el horno microondas por un período corto de tiempo antes de sacarlo.
 - Tenga extrema precaución cuando introduzca una cuchara u otro utensilio en el recipiente.

GUARDE ESTAS INSTRUCCIONES

IMPORTANT SAFETY INSTRUCTIONS

Advantium Oven

⚠ WARNING!

Speedcook oven-safe cookware

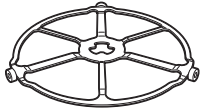

The **turntable** must always be in place when using the oven.



Put food directly on the **non-stick metal tray** to speedcook.

- The oven and door will get very hot when speedcooking.
- Cookware will become hot because of heat transferred from the heated food. Oven mitts will be needed to handle the cookware.
- Do not use coverings, containers or cooking/roasting bags made of foil, plastic, wax or paper when speedcooking.
- Do not cover the turntable, wire oven rack, trays or any part of the oven with metal foil. This will cause arcing in the oven.
- Use the non-stick metal tray in the same way you would use a shallow baking pan or baking tray.
- Place food directly on the trays when cooking unless prompted by the oven to do otherwise.
- Any oven-safe dish can be used in your oven. Recipes in the Advantium Cookbook were tested in Pyrex® glass cookware and Corningware® ceramic casseroles. Cook times and results may vary when using other types of oven-safe dishes. Place them directly on the trays.
- Do not use the oven to dry newspapers.
- Use of the clear glass tray when speedcooking will result in inferior cooking performance.

Oven-safe cookware for Baking, Broiling, Warming, Proofing & Toasting

- The oven and door will get very hot when baking, broiling, warming, proofing or toasting.
- Cookware will become hot. Oven mitts will be needed to handle the cookware.
- Do not use coverings, containers or cooking/roasting bags made of foil, plastic, wax or paper when speedcooking.
- Do not cover the turntable, wire oven rack, trays or any part of the oven with metal foil. This will cause arcing in the oven.
- Use the non-stick metal tray in the same way you would use a shallow baking pan or baking tray.
- Use the aluminum baking sheet on the wire oven rack, and place them on the non-stick metal tray when baking on two levels, broiling or toasting foods.
- Place food directly on the trays when cooking unless prompted by the oven to do otherwise.
- Any oven-safe dish can be used in your oven. Recipes in the Advantium Cookbook were tested in Pyrex® glass cookware and Corningware® ceramic casseroles. Cook times and results may vary when using other types of oven-safe dishes. Place them directly on the trays.
- Do not use the oven to dry newspapers.
- Use of the clear glass tray when baking, broiling, warming, proofing or toasting will result in inferior cooking performance.

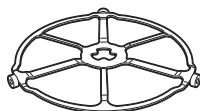

The **turntable** must always be in place when using the oven.



Put food directly on the **non-stick metal tray** to bake on one level.



Put food directly on the aluminum baking sheet on the wire oven rack, and place them on the non-stick metal tray, when baking on two levels, broiling or toasting foods.

SAVE THESE INSTRUCTIONS

INSTRUCCIONES DE SEGURIDAD IMPORTANTES

Horno Advantium

⚠ ¡ADVERTENCIA!

Utensilios para cocción rápida seguros para microondas

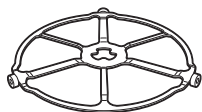

La base giratoria siempre debe estar colocada en su lugar cuando se utiliza el horno.



Coloque la comida directamente en la bandeja antiadherente de metal para realizar la cocción rápida.

- El horno y la compuerta se tornarán muy calientes cuando se utiliza la función de cocción rápida.
- Los utensilios de cocina se tornarán muy calientes debido a la transferencia de calor proveniente de los alimentos calentados. Se requerirán guantes de cocina protectores para manipular los recipientes de cocina.
- No utilice tapas, recipientes o bolsas de cocción/asado fabricadas de láminas de metal, plástico, cera o papel cuando cocine con la función de cocción rápida.
- No cubra la base giratoria, parrilla de alambre, bandejas ni ninguna pieza del horno con lámina de metal. Esto provocará arqueo voltaico en el horno.
- Utilice la bandeja de metal antiadherente e la misma forma que utilizaría una bandeja o charola para hornear plana.
- Coloque los alimentos directamente en las bandejas cuando cocine, a menos que el horno le indique otra cosa.
- Puede utilizar en el horno cualquier plato diseñado para microondas. Las recetas del Libro de cocina Advantium se probaron en recipientes de cocina de vidrio Pyrex® y cacerolas de cerámica Corningware®. Los tiempos y resultados de cocción pueden variar cuando se utilizan otros tipos de recipientes diseñados para hornos microondas. Colóquelos directamente en las bandejas.
- No utilice el horno microondas para secar periódicos.
- Utilizar la bandeja de vidrio transparente mientras utiliza la función de cocción rápida puede producir resultados insatisfactorios.

Recipientes de cocina seguros diseñados para hornear, asar, calentar, activar y tostar

- El horno y la compuerta se tornarán muy calientes cuando se hornea, asa, calienta, activa o tuesta algo.
- Los recipientes de cocina se tornarán muy calientes. Se requerirán guantes de cocina protectores para manipular los recipientes de cocina.
- No utilice tapas, recipientes ni bolsas de cocción/asado fabricadas de láminas de metal, plástico, cera o papel cuando cocine con la función de cocción rápida.
- No cubra la base giratoria, parrilla de alambre, bandejas ni ninguna pieza del horno con láminas de metal. Esto causará arqueo voltaico en el horno.
- Utilice la bandeja metálica antiadherente de la misma forma que utilizaría una bandeja o charola para hornear plana.
- Utilice la lámina de hornear de aluminio en la parrilla de alambre del horno y colóquela en la bandeja metálica antiadherente cuando hornee en dos niveles, ase o tueste alimentos.
- Coloque los alimentos directamente en las bandejas cuando cocine, a menos que el horno le indique hacer otra cosa.
- Puede utilizar en el horno cualquier plato diseñado para microondas. Las recetas del Libro de cocina Advantium se probaron en recipientes de cocina de vidrio Pyrex® y cacerolas de cerámica Corningware®. Los tiempos y resultados de cocción pueden variar cuando se utilizan otros tipos de recipientes diseñados para hornos microondas. Colóquelos directamente en las bandejas.
- No utilice el horno para secar periódicos.
- Utilizar la bandeja de vidrio transparente cuando hornea, asa, calienta, activa o tuesta puede producir resultados insatisfactorios.

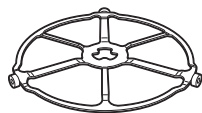

La base giratoria siempre debe estar colocada en su lugar cuando se utiliza el horno.



Coloque los alimentos directamente en la bandeja antiadherente de metal para hornear a un solo nivel.



Coloque los alimentos directamente en la hoja para hornear de aluminio en la parrilla de alambre del horno y colóquelos en la bandeja metálica antiadherente cuando hornee a dos niveles, ase o tueste alimentos.

GUARDE ESTAS INSTRUCCIONES

IMPORTANT SAFETY INSTRUCTIONS

Advantium Oven

▲ **WARNING!**

Microwave-safe cookware

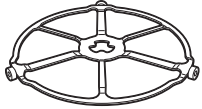

The **turntable** must always be in place when using the oven.



The **clear glass tray** should always be in place when microwaving.

Make sure to use suitable cookware during microwave cooking. Most glass casseroles, cooking dishes, measuring cups, custard cups, pottery or china dinnerware which does not have metallic trim or glaze with a metallic sheen can be used. Some cookware is labeled "suitable for microwaving."

- Place food or microwavable container directly on the clear glass tray to cook your food.
- Use of the non-stick metal tray during microwave cooking will result in inferior cooking performance.

- If you are not sure if a dish is microwave-safe, use this test: Place in the oven both the dish you are testing and a



How to test for a microwave-safe dish.

- glass measuring cup filled with 1 cup of water—set the measuring cup either in or next to the dish. Microwave 30-45 seconds at high. If the dish heats, it should not be used for microwaving.

If the dish remains cool and only the water in the cup heats, then the dish is microwave-safe.

- Cookware may become hot because of heat transferred from the heated food. Oven mitts may be needed to handle the cookware.
- Do not use recycled paper products. Recycled paper towels, napkins and waxed paper may contain metal flecks which could cause arcing or ignite. Paper products containing nylon or nylon filaments should be avoided, as they may also ignite.
- Use foil only as directed in this manual. When using foil in the oven, keep the foil at least 1" away from the sides of the oven.
- Do not use the oven to dry newspapers.
- If you use a meat thermometer while cooking, make sure it is safe for use in microwave ovens.

- Some foam trays (like those that meat is packaged on) have a thin strip of metal embedded in the bottom. When microwaved, the metal can burn the floor of the oven or ignite a paper towel.

- Paper towels, waxed paper and plastic wrap can be used to cover dishes in order to retain moisture and prevent spattering. Be sure to vent plastic wrap so steam can escape.

- Not all plastic wrap is suitable for use in microwave ovens. Check the package for proper use.

- "Boilable" cooking pouches and tightly closed plastic bags should be slit, pierced or vented as directed by package. If they are not, plastic could burst during or immediately after cooking, possibly resulting in injury. Also, plastic storage containers should be at least partially uncovered because they form a tight seal. When cooking with containers tightly covered with plastic wrap, remove covering carefully and direct steam away from hands and face.

- Plastic cookware—Plastic cookware designed for microwave cooking is very useful, but should be used carefully. Even microwave-safe plastic may not be as tolerant of overcooking conditions as are glass or ceramic materials and may soften or char if subjected to short periods of overcooking. In longer exposures to overcooking, the food and cookware could ignite.

Follow these guidelines:

1. Use microwave-safe plastics only and use them in strict compliance with the cookware manufacturer's recommendations.
2. Do not microwave empty containers.
3. Do not permit children to use plastic cookware without complete supervision.

SAVE THESE INSTRUCTIONS

INSTRUCCIONES DE SEGURIDAD IMPORTANTES

Horno Advantium

▲ ¡ADVERTENCIA!

Recipientes de cocina seguros diseñados para microondas

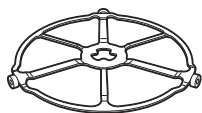

La base giratoria siempre debe estar colocada en su lugar cuando se utiliza el horno.



La bandeja de cristal transparente siempre deberá estar en su lugar cuando se cocina con microondas.

Asegúrese de utilizar recipientes de cocina adecuados durante la cocción a microondas. Se pueden utilizar la mayoría de las cacerolas, platos para cocinar, tazas de medir, tazas normales, cerámica o loza que no tengan bordes metálicos o vidriados con un recubrimiento metálico. Algunos recipientes de cocina se encuentran marcados como adecuados para microondas.

■ Coloque los alimentos o recipiente para microondas directamente en la bandeja de vidrio transparente para cocinar sus alimentos.

■ La utilización de la bandeja metálica antiadherente durante la cocción en microondas puede producir resultados insatisfactorios.

■ Si no está seguro de que su recipiente de cocina sea adecuado para microondas, realice la siguiente prueba: coloque en el horno el plato que desee probar y una taza de medida de vidrio llena con 1 taza de agua coloque la taza junto o sobre el plato. Prenda el microondas durante 30–45 segundos a alta potencia. Si el plato se calienta, no debe utilizarse en el microondas.



Cómo probar si un envase es seguro para usarse en un horno de microondas

Si el plato permanece frío y sólo se calienta el agua de la taza, entonces el plato es adecuado para microondas.

■ Los utensilios de cocina pueden tornarse muy calientes debido a la transferencia de calor proveniente de los alimentos calentados. Podrían requerirse guantes de cocina para manipular los recipientes de cocina.

■ No utilice productos de papel reciclado. Las toallas, servilletas y papel encerado fabricados de material reciclado pueden contener partículas metálicas que pueden causar arco eléctrico o prender fuego. Se deben evitar los productos de papel que contienen nylon o filamentos de nylon, ya que también pueden incendiarse.

■ Utilice las láminas metálicas únicamente como se indica en este manual. Cuando utilice la lámina de metal en el horno, mantenga la lámina por lo menos 1" alejada de los costados del horno.

■ No utilice el horno para secar periódicos.

■ Si utiliza un termómetro de carne mientras cocina, asegúrese que sea seguro para utilizarse en hornos microondas.

■ Algunas bandejas de espuma (como aquellas en las que se empaca la carne) tienen una tira de metal delgada empotrada en la parte inferior. Cuando se cocinan con microondas, el metal puede quemar el fondo del horno o hacer que arda una toalla de papel.

■ Se puede utilizar toallas de papel, papel encerado y las envolturas plásticas para cubrir los platos con el propósito de mantener la humedad y prevenir los salpicones. Asegúrese de ventilar cortando la envoltura plástica para que pueda escapar el vapor.

■ No todas las cubiertas plásticas son adecuadas para hornos microondas. Lea en la caja las instrucciones correspondientes.

■ Se deben cortar, perforar o ventilar como se indica en la caja las bolsas de cocina "hervibles" y bolsas plásticas cerradas herméticamente. De lo contrario, el plástico puede reventarse durante o inmediatamente después de la cocción, resultando en una posible lesión. También, los recipientes de almacenamiento plásticos deben al menos estar parcialmente descubiertos debido a que forman un sello muy ajustado. Al cocinar con recipientes cubiertos con envoltura plástica de manera muy ajustada, quite cuidadosamente la cubierta y dirija el vapor fuera y alejado de manos y rostro.

■ Recipientes de cocina plásticos—Los recipientes de cocina diseñados para microondas son muy útiles, pero deben utilizarse con cuidado. Incluso el plástico diseñado para microondas podría no tolerar condiciones de sobre cocción, así como los materiales de vidrio o cerámica y podrían suavizarse o carbonizarse si se exponen a periodos cortos de sobre cocción. En exposiciones más prolongadas a la sobrecocción, los alimentos y los recipientes de cocina podrían coger fuego.

Siga las siguientes pautas:

1. Utilice plásticos seguros para microondas únicamente y utilícelos estrictamente según las especificaciones del fabricante.
2. No cocine en el microondas recipientes vacíos.
3. No permita que los niños utilicen recipientes de plástico sin vigilarlos bien.

GUARDE ESTAS INSTRUCCIONES

IMPORTANT SAFETY INSTRUCTIONS

Advantium Oven

GROUNDING INSTRUCTIONS

⚠ WARNING!

Improper use of the grounding plug can result in a risk of electric shock.

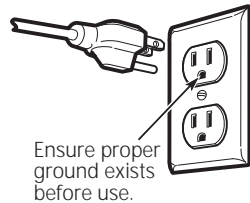

This appliance must be grounded. In the event of an electrical short circuit, grounding reduces the risk of electric shock by providing an escape wire for the electric current.

This appliance is equipped with a power cord having a grounding wire with a grounding plug. The plug must be plugged into an outlet that is properly installed and grounded.

Consult a qualified electrician or service technician if the GROUNDING INSTRUCTIONS are not completely understood, or if doubt exists as to whether the appliance is properly grounded.

If the outlet is a standard 2-prong wall outlet, it is your personal responsibility and obligation to have it replaced with a properly grounded 3-prong wall outlet.

Do not under any circumstances cut or remove the third (ground) prong from the power cord.

We do not recommend using an extension cord with this appliance. If the power cord is too short, have a qualified electrician or service technician install an outlet near the appliance. (See EXTENSION CORDS section.)

For best operation, plug this appliance into its own electrical outlet to prevent flickering of lights, blowing of fuse or tripping of circuit breaker.

ADAPTER PLUGS

Usage situations where appliance's power cord will be disconnected infrequently.

(Adapter plugs not permitted in Canada)

Align large prongs/slots

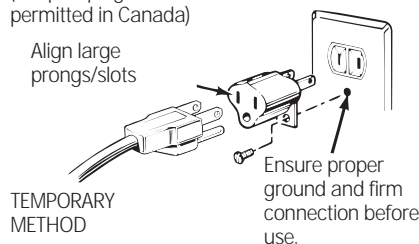

Because of potential safety hazards under certain conditions, *we strongly recommend against the use of an adapter plug.* However, if you still elect to use an adapter, where local codes permit, a **TEMPORARY CONNECTION** may be made to a properly grounded wall receptacle by the use of a UL listed adapter which is available at most local hardware stores.

The larger slot in the adapter must be aligned with the larger slot in the wall receptacle to provide proper polarity in the connection of the power cord.

CAUTION: Attaching the adapter ground terminal to the wall receptacle cover screw does not ground the appliance unless the cover screw is metal, and not insulated, and the wall receptacle is grounded through the house wiring.

You should have the circuit checked by a qualified electrician to make sure the receptacle is properly grounded.

When disconnecting the power cord from the adapter, always hold the adapter with one hand. If this is not done, the adapter ground terminal is very likely to break with repeated use. Should this happen, **DO NOT USE** the appliance until a proper ground has again been established.

Usage situations where appliance's power cord will be disconnected frequently.

Do not use an adapter plug in these situations because frequent disconnection of the power cord places undue strain on the adapter and leads to eventual failure of the adapter ground terminal. You should have the 2-prong wall receptacle replaced with a 3-prong (grounding) receptacle by a qualified electrician before using the appliance.

SAVE THESE INSTRUCTIONS

INSTRUCCIONES DE SEGURIDAD IMPORTANTES

Horno Advantium

INSTRUCCIONES DE TOMA DE TIERRA

⚠ ¡ADVERTENCIA!

El uso indebido del enchufe de tierra puede resultar en riesgo de descarga eléctrica.

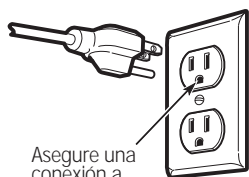

Asegure una conexión a tierra firme y adecuada antes del uso

Este electrodoméstico debe estar conectado a tierra. Si se produjera un cortocircuito, la toma de tierra reduce el riesgo de descarga eléctrica al proveer un cable de escape para la corriente eléctrica.

Este electrodoméstico está equipado con un cable de corriente que dispone de un hilo para toma de tierra con un enchufe con toma de tierra. El enchufe debe estar conectado a una toma de corriente que esté debidamente instalada y con salida a tierra.

Consulte con un electricista cualificado o un técnico de reparaciones si no entiende completamente las instrucciones sobre la toma de tierra, o si tuviese alguna duda sobre si su aparato está debidamente conectado a tierra.

Si la toma de corriente es un modelo estándar de dos clavijas, es su responsabilidad personal y su obligación el reemplazarla por una toma adecuada para tres clavijas con conexión a tierra.

Bajo ninguna circunstancia debe cortar o quitar la tercera clavija (tierra) del cable de corriente.

No use un enchufe adaptador con este electrodoméstico.

No use un cable extensor de corriente con este electrodoméstico. Si el cable de corriente es demasiado corto, haga que un electricista cualificado o un técnico de reparaciones instalen una toma de corriente cerca del electrodoméstico.

Para un mejor funcionamiento, enchufe este electrodoméstico en una toma de corriente exclusiva para evitar parpadeos de luz, fusibles quemados o que salte el diferencial.

ADAPTADORES DE ENCHUFE

Situaciones de uso en que el cable de corriente del electrodoméstico será desconectado con poca frecuencia.

(Enchufes adaptadores no permitidos en Canadá)

Alinee las patas/
ranuras largas

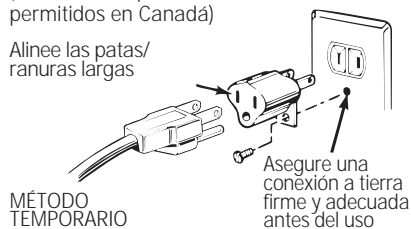

MÉTODO TEMPORARIO

Debido a los posibles riesgos sobre la seguridad bajo ciertas condiciones, **recomendamos enfáticamente no usar adaptadores de enchufe**. Sin embargo, si aún elije usar un adaptador, cuando los códigos locales lo permitan, se podrá realizar una **CONEXIÓN TEMPORARIA** a un tomacorriente de pared de 2 enchufes adecuadamente conectado a tierra, utilizando un adaptador que figure en la lista de UL que se encuentre disponible en la mayoría de los locales de repuestos.

La ranura más larga del adaptador deberá estar alineada con la ranura más larga en el tomacorriente de pared, a fin de brindar la polaridad adecuada en la conexión del cable de corriente.

PRECAUCIÓN: Conectar la terminal del adaptador con conexión a tierra al tornillo de la cubierta del tomacorriente no conecta el electrodoméstico a tierra, a menos que el tornillo de la cubierta sea de metal, y no esté aislado, y que el tomacorriente esté conectado a tierra a través del cableado del hogar.

Contrate a un electricista calificado para que controle el circuito, a fin de asegurar que el tomacorriente esté correctamente conectado a tierra.

Cuando desconecte el cable de corriente del adaptador, siempre sostenga el adaptador con una mano. En caso de no hacer esto, es muy probable que la terminal del adaptador con conexión a tierra se rompa con el uso repetido. Si esto sucede, **NO USE** el electrodoméstico hasta que se haya establecido una conexión a tierra adecuada nuevamente.

Situaciones de uso en que el cable de corriente del electrodoméstico será desconectado con frecuencia.

No use un adaptador de enchufe en estas situaciones, ya que una desconexión frecuente del cable de corriente representa un esfuerzo excesivo sobre el adaptador y conduce finalmente a una falla de la terminal del adaptador con conexión a tierra. Deberá solicitar a un electricista calificado el reemplazo del tomacorriente de 2 cables por uno de 3 cables (con conexión a tierra), antes de usar el electrodoméstico.

GUARDE ESTAS INSTRUCCIONES

IMPORTANT SAFETY INSTRUCTIONS

Advantium Oven

⚠ WARNING!

SAFETY PRECAUTIONS

- Don't defrost frozen beverages in narrow-necked bottles (especially carbonated beverages). Even if the container is open, pressure can build up. This can cause the container to burst, possibly resulting in injury.
- Foods cooked in liquids (such as pasta) may tend to boil more rapidly than foods containing less moisture. Should this occur, refer to the *Care and Cleaning of the oven* section for instructions on how to clean the inside of the oven.
- Hot foods and steam can cause burns. Be careful when opening any containers of hot food, including popcorn bags, cooking pouches and boxes. To prevent possible injury, direct steam away from hands and face.
- Do not overcook potatoes. They could dehydrate and catch fire, causing damage to your oven.
- Avoid heating baby food in glass jars, even with the lid off. Make sure all infant food is thoroughly cooked. Stir food to distribute the heat evenly. Be careful to prevent scalding when warming formula. The container may feel cooler than the formula really is. Always test the formula before feeding the baby.
- Do not attempt to deep fry in the oven.
- Oversized foods or oversized metal utensils should not be inserted in a microwave/toaster oven as they may create a fire or risk of electric shock.
- Do not clean with metal scouring pads. Pieces can burn off the pad and touch electrical parts involving a risk of electric shock.
- Do not store any materials, other than manufacturer's recommended accessories, in this oven when not in use.
- Do not immerse cord or plug in water.
- Keep cord away from heated surfaces.

NOTICE—PACEMAKERS

Most pacemakers are shielded from interference from electronic products, including microwaves. However, patients with pacemakers may wish to consult their physicians if they have concerns.

SAVE THESE INSTRUCTIONS

INSTRUCCIONES DE SEGURIDAD IMPORTANTES

Horno Advantium

⚠ ¡ADVERTENCIA!

PRECAUCIONES DE SEGURIDAD

- No descongele bebidas en botellas con cuellos angostos (especialmente bebidas gaseosas/carbonatadas). Incluso si el recipiente se encuentra abierto, se puede acumular presión. Esto puede ocasionar que el recipiente explote, dando posiblemente como resultando una lesión.
- Los alimentos cocinados en líquidos (tales como la pasta) pueden tener la tendencia de hervir más rápidamente que los alimentos que contienen menos humedad. En caso de que ocurra esto, consulte la sección de *Mantenimiento y limpieza del horno* para las instrucciones de cómo limpiar el interior del horno.
- Los alimentos calientes y el vapor pueden provocar quemaduras. Tenga cuidado al abrir cualquier tipo de recipiente que contenga alimentos calientes, incluyendo bolsas de palomitas de maíz, bolsas y cajas de cocina. Para prevenir la posibilidad de lesiones, dirija el vapor en dirección contraria a las manos y el rostro.
- No cocine las papas excesivamente. Pueden deshidratarse y provocar fuego, causando daños al horno.
- Evite calentar los alimentos para bebé en frascos de vidrio, incluso sin la tapa. Asegúrese de cocinar bien toda la comida del bebé. Remueva los alimentos para distribuir el calor uniformemente. Tenga cuidado de evitar las escaldaduras al calentar la fórmula. El recipiente puede sentirse más frío de lo que la fórmula realmente está. Revise siempre la fórmula antes de alimentar al bebé.
- Nunca intente freír en abundante aceite en el microondas.
- Alimentos o utensilios de metal de gran tamaño no deben insertarse en un horno de microondas / tostadora, ya que pueden crear un riesgo de incendio o descarga eléctrica.
- No limpie con estropajos de metal. Las piezas pueden quemar la almohadilla y tocar las partes eléctricas que implican un riesgo de descarga eléctrica.
- No almacene ningún material, excepto los accesorios recomendados por el fabricante, en este horno cuando no esté en uso.
- No guarde este electrodoméstico al aire libre.
- Mantenga el cable de corriente alejado de superficies calientes.

AVISO—MARCAPASOS

La mayoría de los marcapasos se encuentran protegidos contra la interferencia de productos electrónicos, incluyendo los microondas. Sin embargo, los pacientes que tengan marcapasos deberían consultar a sus médicos si tienen alguna duda.

GUARDE ESTAS INSTRUCCIONES

What is Advantium?

Advantium Oven

Getting to know Advantium

The new Advantium oven uses breakthrough Speedcook technology to harness the power of light. The Advantium oven cooks the outside of foods much like conventional radiant heat, while also penetrating

the surface so the inside cooks simultaneously. While halogen light is the primary source of power, a “microwave boost” is added with certain foods. Foods cook evenly and fast, retaining their natural moisture.

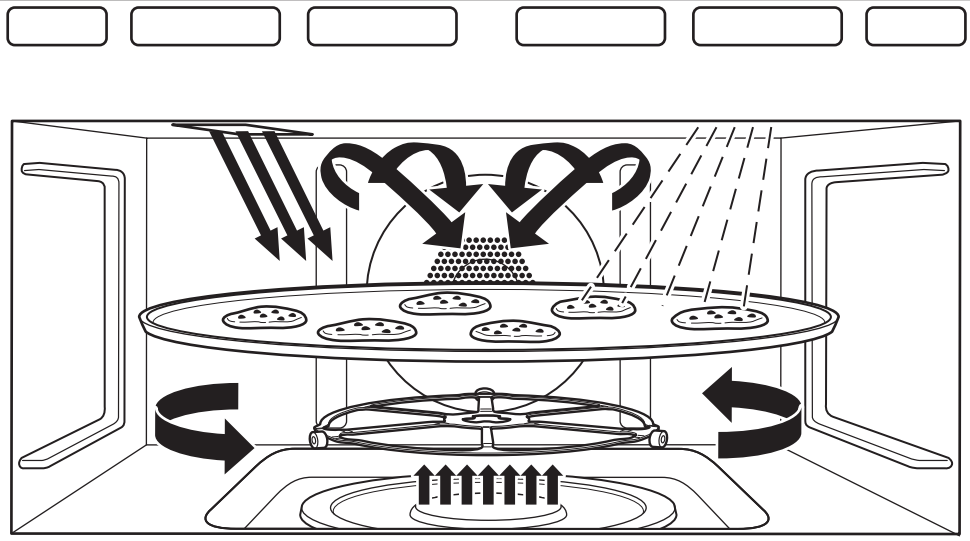

Turntable

- The turntable rotates to ensure even cooking.

Controls

- The oven control contains preset recipes.
- Turn and press dial makes menu selection easy.

Halogen Lamp and Ceramic Heaters

- One 500 watt halogen bulb and one 700 watt ceramic heater cook food from above.
- One 375 watt ceramic heater cooks food from below.

Rear Convection Heat Element

- Operates when using bake.

Microwave

- A microwave “boost” is automatically added with certain foods.
- The oven can also be used as a 975 watt microwave oven.

Advantium Quick Start

Advantium Oven

Set the clock



When you first plug in the oven or after a power outage:

1. Turn the selector dial to set the hour. Press the dial to enter.
2. Turn the dial to set the minute. Press the dial to enter.
3. Turn the dial to select AM or PM. Press the dial to enter.

To change the time:

1. Press the OPTIONS pad.
2. Turn the dial to SET CLOCK. Press the dial to enter and follow the display directions to set.

Microwaving with Express



Press EXPRESS repeatedly for 30-second increments of microwave cooking time.

The oven starts immediately.

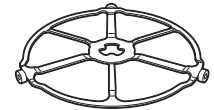

The **turntable** must always be in place when using the oven.



The **clear glass tray** should always be in place when **microwaving**.

Begin speedcooking

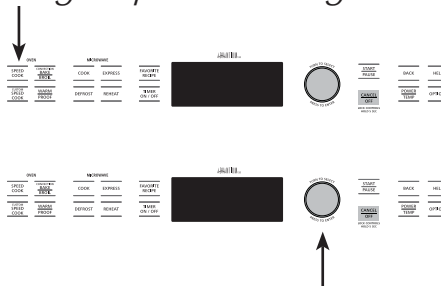

1. Press the SPEEDCOOK pad.
2. Turn the dial to FOOD MENU. Press the dial to enter.
3. Turn the dial to select the type of food category you want. Press the dial to enter it.
4. Turn the dial to select the specific food. Press the dial to enter it.
5. Turn the dial to select the amount, size, and/or doneness (if required, the oven will prompt you). Press the dial after each selection.

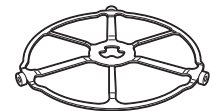

The **turntable** must always be in place when using the oven.



Put food directly on the **non-stick metal tray** to speedcook.



6. Once the display shows **ADJUST TIME OR START**, either press the dial or start pad to start cooking.

■ Press **CANCEL/OFF** at any time to stop cooking.

Speedcook Menu Guide

Advantium Oven

Display prompts

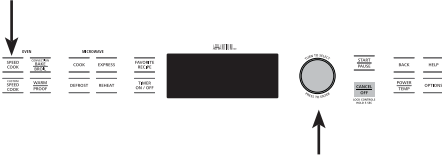

After pressing the SPEEDCOOK pad, the oven will prompt you to make several selections, such as the example below.



NOTE: When speedcooking, use the non-stick metal tray.

1. Turn the dial until **FOOD MENU** appears. Press the dial to enter.
2. Turn the dial until **POULTRY** appears. Press the dial to enter.
3. Turn the dial until **CHICKEN, BONELESS** appears. Press the dial to enter.
4. Turn the dial to **Select SIZE: MEDIUM (7-9 oz each)**. Press the dial to enter.
5. Turn the dial to **Select amount: 1-2 pieces**. Press the dial to enter.
6. Use **NON-STICK METAL TRAY** is displayed.

Pre-set speedcook menu selections

■ After a cooking cycle has been completed, use the Resume feature to cook for additional time.

■ To review settings during cooking, press the selector dial.

<i>Food Category</i>	<i>Menu Selection</i>	<i>Food Category</i>	<i>Menu Selection</i>
Appetizers	Bagel Bites Cheese Sticks Egg Rolls (Frozen) Hot Dip (2-4 Cups) Jalapeno Poppers Meat Balls (Frozen) Nachos Nuts Roasted Onion Rings Pizza Rolls Soft Pretzels (Frozen)	Meats	Filet Mignon Hamburger Lamb Chops Pork Chops Roast - Pork Roast - Beef Ribeye Steak Sirloin Steak Strip Steak T-Bone Steak Tenderloin
Breads	Bagels (frozen) Biscuits Bread Sticks Cheese Bread Crescent Rolls Dinner Rolls Garlic Bread Quick Bread (9x5) Sweet Rolls/Danish Taco Shells (boxed) Texas Toast	Pizza	Deli/Fresh Use Precooked Crust Frozen Pizza
Breakfast	Bagels (frozen) Belgian Waffles Breakfast Pizza Casserole (egg 7x11) Coffee Cake French Toast Pancakes (frozen) Hashbrown Patties Rolls (refrigerated) Sausage Biscuit Sausage Strudel (frozen) Sweet Rolls/Danish Turnovers Waffles (frozen)	Potatoes	Baked Potato Hashbrown Patties Frozen Fries Frozen Nugget Sweet Potato/Yam
Desserts	Brownies Cakes (mix 9x13) Cobbler (fresh 7x11) Coffee Cake Cookies Pie (fresh fruit) Rolls (refrigerated) Turnovers	Poultry	Chicken, Bone-In Chicken, Boneless Chicken Fillet (frozen) Chicken Finger (frozen) Chicken, Fried (frozen) Chicken Nugget (frozen) Chicken Patty (frozen) Chicken Tender (frozen) Chicken Wings (frozen) Chicken, Whole Turkey
Entree	Burritos (frozen) Chimichanga Casserole Egg Rolls (frozen) Enchilada (fresh) Lasagna Meatloaf (9x5) Quesidillas (fresh) Stuffed Peppers (6)	Sandwich	Corn Dog (frozen) Crescent Roll Hot Dog Grilled Sandwich Hot Dog in a Bun Pocket Sandwich Taqitos (frozen)
		Seafood	Cod Fillets Fish Sticks (frozen) Frozen Breaded Lobster Tails Orange Roughy Fillet Salmon Sea Bass Shellfish Swordfish Steak Tilapia Tuna Steaks Whitefish
		Side Dish	Refried Beans (16 oz) Roasted Asparagus Roasted Bell Pepper Roasted Chilis (6) Roasted Corn Roasted Garlic Roasted Mixed Vegetables Stuffing (mix) Stuffed Mushrooms Stuffed Tomatoes

Oven Features

Advantium Oven

Oven features

Throughout this manual, features and appearance may vary from your model.

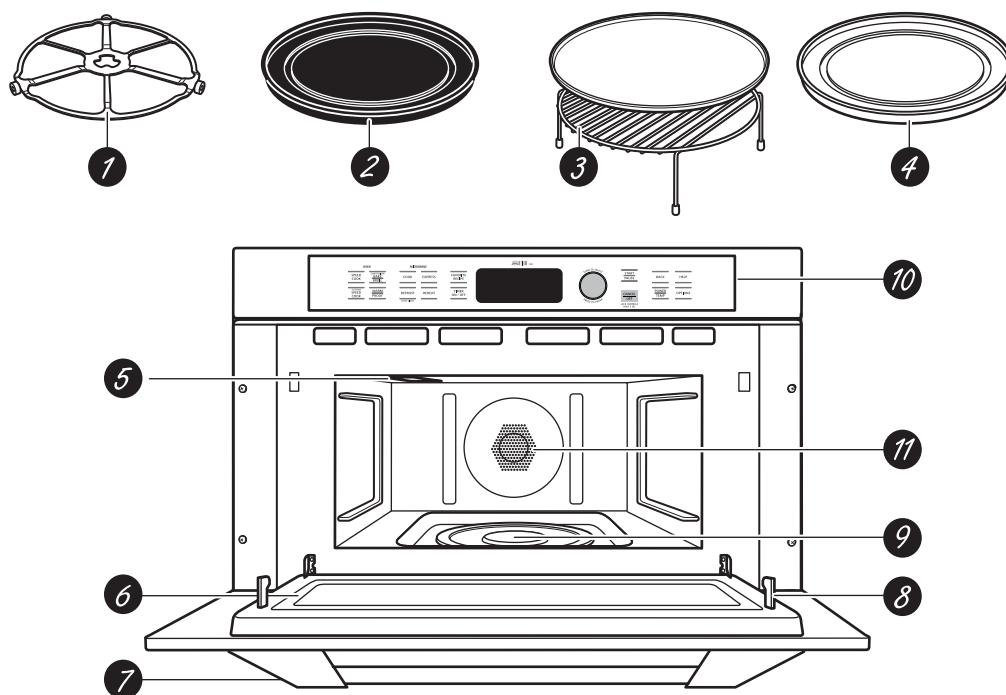

NOTE: Handle appearance may differ on some models.

- 1** *Turntable*
The turntable must always be in place, on the oven floor, for all cooking. Be sure the turntable is seated securely over the spindle in the center of the oven.
- 2** *Non-stick Metal Tray*
Put food directly on the non-stick metal tray and place on the turntable when using the speedcook and bake features.
- 3** *Wire Oven Rack and Aluminum Baking Sheet*
Put food directly on the aluminum baking sheet on the wire oven rack, and place them on the non-stick metal tray, when baking on two levels, broiling or toasting foods.
- 4** *Clear Glass Tray*
Place on the turntable when using the microwave features. Place food or microwave-safe cookware directly on the tray.
- 5** *Upper Halogen Lamp/Ceramic Heater*
Operates when using speedcook or broil.
- 6** *Window*
Allows cooking to be viewed while keeping microwaves confined in the oven.
- 7** *Door Handle*
Pull to open the door. The door must be securely latched for the oven to operate.
- 8** *Door Latches*
- 9** *Lower Ceramic Heater*
Operates when using speedcook.
- 10** *Control Panel*
The pads used to operate the oven are located on the control panel.
- 11** *Rear Convection Heat Element*
Operates when using bake.

Oven Features

Advantium Oven

Cooking controls

With your Advantium oven, you can cook with high-intensity halogen lights, ceramic heaters and convection heating element, and/or conventional microwave energy.



- 1** **SPEEDCOOK/Repeat Last**
Press this pad to access the pre-set speedcook menu. Press and hold for 3 seconds to repeat the last cooking selection.
- 2** **CONV BAKE/BROIL**
Press this pad to bake, broil or toast.
- 3** **CUSTOM SPEEDCOOK**
Press this pad to set your own speedcook program.
- 4** **WARM/PROOF**
Select WARM to keep hot, cooked foods at serving temperature.
Select PROOF to set for a warm environment useful for rising yeast-leavened products.
- 5** **COOK (Microwave)**
Press this pad to microwave food that is not in the FAVORITE RECIPE section.
- 6** **EXPRESS (Microwave)**
Press for 30 seconds of microwave cooking time. Each time the pad is pressed adds an additional 30 seconds to the remaining cooking time. The oven starts immediately.
- 7** **DEFROST (Microwave)**
Press this pad to defrost, soften or melt frozen foods.
- 8** **REHEAT (Microwave)**
Press this pad to reheat servings of previously cooked foods or a plate of leftovers.
- 9** **FAVORITE RECIPE**
Press this pad to add, edit (change) or remove a recipe from the memory.
- 10** **TIMER**
Press this pad to set the minute timer.
- 11** **DISPLAY**
Shows and instructs the use of all features on the oven.
- 12** **SELECTOR DIAL—Turn to select, Press to enter** First turn, then press the dial to make option, food power level or temperature selections. Also use the dial to increase (turn clockwise) or decrease (turn counterclockwise) cooking times.
- 13** **START/PAUSE**
Press this pad to start or pause any cooking function.
- 14** **CANCEL/OFF**
Press this pad to cancel **ALL** oven programs except the clock and timer.
- 15** **BACK**
Press this pad to step back one or more levels in the program process, such as when entering custom recipes.
- 16** **HELP**
Press this pad to find out more about your oven's features.
- 17** **POWER/TEMP**
During cooking, press this pad and turn/press the selector dial to change the microwave power level, the convection bake temperature or the speedcook temperature by adjusting the upper and lower lamp and heater settings.
- 18** **OPTIONS**
Press this pad to set the **Clock** and access the **Beeper Volume, Clock Display ON/OFF, Display Scroll Speed, Delay Start** and **Reminder** features.

Using speedcook features

⚠ CAUTION: When using speedcook programs, remember that the oven, door and dishes will be very hot!

Prior to the first use of your oven, the clock must be set. See the Advantium Quick Start section.

Before you begin, make sure the turntable is in place. Use the non-stick metal tray and your own glass or ceramic cookware, if needed.

Cómo utilizar las funciones de cocción rápida

⚠ PRECAUCIÓN: cuando utilice los programas de cocción rápida, recuerde que el horno, compuerta y los platos se encontrarán muy calientes!

Antes de utilizar su horno por primera vez, se debe programar el reloj. Consulte la sección de Inicio rápido de Advantium.

Antes de empezar, asegúrese que se encuentre colocada la base giratoria. Si es necesario, utilice la bandeja de metal antiadherente y sus propios recipientes de cocina de cerámica o vidrio.

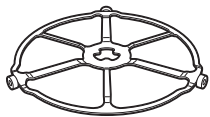

The turntable must always be in place when using the oven.



Put food directly on the non-stick metal tray to speedcook.

SPEEDCOOK PRE-SET FOOD SELECTIONS:

■ Appetizers	■ Desserts	■ Pizza	■ Sandwich
■ Breads	■ Entrees	■ Potatoes	■ Seafood
■ Breakfast	■ Meats	■ Poultry	■ Side Dish

To use a pre-set speedcook menu



Advantium is already pre-set to cook over 175 popular dishes.

1. Press the speedcook pad.

If no selection is made within 15 seconds, the display will revert back to the time of day.

2. Turn the selector dial to select the type of food category you want. Press the dial to enter.

3. Turn the selector dial to select the specific food (menu selection). Press the dial to enter.

4. Turn the selector dial to select amount, size, and/or doneness (if required, the oven will prompt you). Press the dial after each selection.

5. Once the display shows: **ADJUST TIME** or **START** either press start or the selector dial to start cooking.

Turn the food over when the oven signals **TURN FOOD OVER** (for certain foods).

When the oven signals **CHECK for DONENESS**, check to see if your food is done to your liking (for certain foods).

To review settings during cooking, press the selector dial.

If you enter an undesired selection at any time, simply press the **BACK** pad and re-enter the desired selections.

■ Early in a speedcook program, you will see **OPTIMIZING COOK TIME** on the display. The oven automatically senses the electrical voltage level in your home and adjusts the cooking time up or down for proper cooking.

■ If the door is opened during cooking, the oven will stop and **PAUSE** will appear in the display. Close the door and press the **START/PAUSE** pad to resume cooking.

■ At anytime during cooking you can turn the selector dial to change the cooking time. You can change power levels by pressing **POWER/TEMP**.

■ To assure consistent cooking results, the oven may adjust power levels downward if the oven is hot at the beginning of a program.

■ At the end of cooking, the automatic fan may continue to run for a short time to cool internal components.

■ To cook for additional time after a cooking cycle has been completed, use the resume feature.

Speedcooking

Advantium Oven

Cooking tips for great tasting results

To ensure consistent and even browning when cooking foods directly on the non-stick metal tray, arrange food as shown below.

Foods can touch but should not overlap.

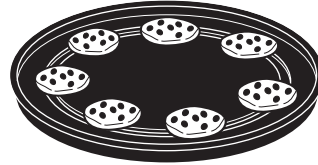

Circular pattern
(Example: biscuits, cookies)



Side by side pattern
(Example: meats and poultry)



Spoke pattern
(Example: crescent rolls, breadsticks)

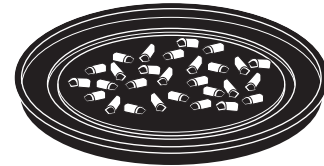

Single layer
(Example: appetizers)

*Fresh meat, chicken, fish or seafood that has been frozen should be **thawed before cooking** (the microwave defrost feature can be used). For other frozen prepackaged foods, follow package directions.*

Repeat last



Use this time saving feature for cooking repetitive items like cookies or appetizers.

1. Press and hold the SPEEDCOOK pad for 3 seconds.
2. The last pre-set food will be

NOTE: The last program used is stored for two hours.

- displayed.
3. Press the START/PAUSE pad or the selector dial to start cooking.

Resume feature

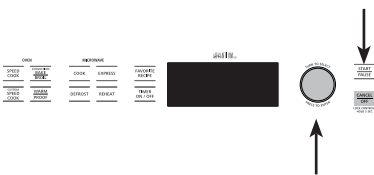

1. If your food needs to cook a bit longer, you can restart the oven by pressing the START/PAUSE pad or selector dial.
2. **RESUME COOKING** will be displayed and the oven will restart immediately at 10% of the original time.

The program stays in memory for 10 minutes. After that you will need to begin the program again. See *To use a pre-set speedcook menu.*

Speedcooking

Advantium Oven

Speedcook power level



Advantium uses power from a high intensity halogen light, ceramic heaters, and microwaves to cook food from the top, bottom, and interior simultaneously to seal in moisture and flavor.

When using the pre-set speedcook recipes on the food menu, the power levels are already selected for you. However, these power levels can be adjusted before or during cooking. See POWER/TEMP in the Cooking Controls section. The custom speedcook feature allows you to speedcook items not on the pre-set food menu by selecting your own cook time and power level settings.

Each power level gives you heater power and microwave energy for a certain percentage of the time.

UPPER POWER (U) controls both the upper heater and microwave power. A higher **UPPER POWER** setting will utilize more upper heater power, browning food faster on top. A lower **UPPER POWER** setting utilizes more microwave power, causing food to cook more evenly throughout.

Select a higher setting for foods such as pizza and baked goods. Select a lower setting for foods such as casseroles, meat and fish.

LOWER POWER (L) controls the lower heater.

Select a higher setting to brown foods more on the bottom. Select a lower setting for less browning on the bottom.

1. Press the SPEEDCOOK pad and turn the dial to select FOOD MENU or FAVORITE RECIPE, or press CUSTOM SPEEDCOOK to manually set power level and timer. Press the dial to enter.
2. Turn the dial to select a food, time or power level as prompted. Press the dial to enter.
3. To change the power level when prompted by the display, turn the dial clockwise to increase or counterclockwise to decrease the upper power level. Press the dial to enter.
4. Microwave levels are set automatically based on the upper and lower lamp settings.
5. Press the START/PAUSE pad or the selector dial to start cooking.

If you do not want to change one of the settings, just press the dial to move to the next selection.

NOTE: Be careful when adjusting power levels so that you do not over- or undercook food.

Follow these general guidelines when selecting the best U= and L= settings for your favorite recipes:

U = Select a higher setting for thin foods requiring a golden brown top (example: fish fillets, toast, boneless chicken breasts). Select a lower setting for thicker foods and foods with high sugar or fat content (example: cakes, roasts).

L = Select a higher setting for thick or dense foods that may not cook quickly in the center (example: casseroles). Select a lower setting for thin foods (example: cookies) and foods containing high fat or sugar content (example: pastry, cakes).

Speedcooking

Advantium Oven

Speedcook cookware

- Follow cookware suggestions on the oven display or in the Cookbook or Cooking guide.
- Cookware will become hot because of heat transferred from the heated food. Oven mitts will be needed to handle the cookware.
- Place food directly on the non-stick metal tray when cooking, unless prompted by the oven to do otherwise.
- Use the non-stick metal tray in the same way you would use a shallow baking pan or baking tray.
- In addition to the cookware provided, you can use non-metal casserole dishes, pie plates and other heat-safe cookware. Place them directly on the turntable.

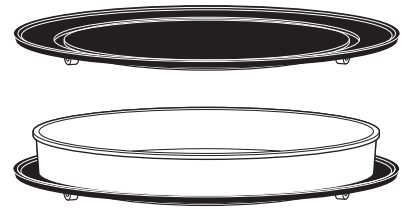

- Be sure to select a size that will rotate easily.
- Place the non-stick metal tray on the turntable. Place glass or ceramic cookware on the tray.
- Do not use cookware or coverings made of paper, plastic, or foil when cooking during a speedcook cycle.

Custom speedcook



Advantium gives you the flexibility to cook your favorite dishes.

If you want to cook a food item that is not among the pre-set selections, use custom speedcook.

1. Press the CUSTOM SPEEDCOOK pad.

If no entries are made within 15 seconds, the display will revert back to the time of day.

2. Turn the selector dial to select the cooking time. Press the dial to enter.

The display will prompt you to select the power level(s).

3. Turn the dial clockwise to increase or counterclockwise to decrease the upper power level. Press the dial to enter.

4. Turn the dial to change the lower power level. Press the dial to enter.
5. Press the START/PAUSE pad or press the selector dial to start cooking.

For power level and cooking time suggestions, use your cooking guide or cook book.

Speedcooking

Advantium Oven

*Favorite recipe—
to enter
and save*



Add and save up to 30 of your own Speedcook or microwave recipes, or pre-set Speedcook menu recipes as a favorite recipe. Once it's done, you can quickly recall your favorite so that your food cooks just the way you want it every time!

1. Press the FAVORITE RECIPE or the SPEEDCOOK pad.
2. Turn the dial until *FAVORITE RECIPE* appears. Press the dial to enter. (Skip this step if the FAVORITE RECIPE pad was pressed in step 1.)
3. Turn the dial until *ADD RECIPE* appears. Press the dial to enter.
4. Turn the dial to *COPY SPEED RECIPE* or to *ADD NEW RECIPE*. Press the dial to enter.

If *COPY SPEED RECIPE* was selected, turn dial to food type(s) and press the FAVORITE RECIPE pad to enter and save the recipe.

If *ADD NEW RECIPE* was selected, turn the dial to select *SPEEDCOOK* or *MICROWAVE* recipe. Press the dial to enter and continue with these steps.

5. *SELECT COOK TIME* appears. Turn the dial to select the cooking time. Press the dial to enter.

The display will prompt you to select the power level(s).

6. Turn the dial clockwise to increase or counterclockwise to decrease the power level(s). Press the dial to enter.

For power level and cooking time suggestions, use your cooking guide or cook book.

7. *SPELL THE FOOD NAME* appears. Turn the dial to the first letter of your food description and press the dial to enter. Continue this process to spell the rest of the food name. Press the START/PAUSE pad to save the recipe and its name.

*Favorite recipe—
to find
and use*



To find and use stored favorite recipes:

1. Press the FAVORITE RECIPE or the SPEEDCOOK pad.
2. Turn the dial until *FAVORITE RECIPE* appears. Press the dial to enter.
3. Turn dial to *USE FAVORITE RECIPE* and press to enter.

4. The recipe names you entered will appear.
5. Turn dial until the recipe you want is displayed and press the dial to enter.
6. Press the START/PAUSE pad or press the selector dial to start cooking.

Favorite recipe— to adjust or change



To adjust or change stored custom speedcook recipes:

1. Press the FAVORITE RECIPE or the SPEEDCOOK pad.
2. Turn the dial until FAVORITE RECIPE appears. Press the dial to enter.
3. Turn the dial until *EDIT RECIPE* appears. Press the dial to enter.
4. Turn the dial to the recipe you want to change. Press the dial to enter. Current settings appear.

5. Press the dial to edit.
6. The display will prompt you to select the power level(s) and edit the name. Turn the dial and press to enter the appropriate settings.

For power level and cooking time suggestions, use your cooking guide or cook book.

Favorite recipe— to delete



To delete stored custom speedcook recipes:

1. Press the FAVORITE RECIPE or the SPEEDCOOK pad.
2. Turn the dial until FAVORITE RECIPE appears. Press the dial to enter.
3. Turn the dial until *DELETE RECIPE* appears and press the dial to enter.
4. Turn dial to the recipe you want to delete and press the dial to enter.

Things that are normal

Cooking Times

- When speedcooking preprogrammed foods, you may see *OPTIMIZING COOK TIME* in the display several seconds after you press START/PAUSE. The oven automatically senses the electrical voltage level in your home and adjusts the cooking time up or down for proper cooking.

Fan/Vent

- The fan will be on during cooking. At the end of cooking, the automatic fan may continue to run for a short time, and the display will read *Oven is Cooling*. The fan will automatically shut off when the internal parts of the oven have cooled.
- The oven vent will emit warm air while the oven is on.

Lights

- When the oven is on, light may be visible around the door or outer case.
- The halogen lights will dim and cycle on and off during a speedcook cycle, sometimes even at full power levels. This is normal. The oven senses the heat level and adjusts automatically.

Oven Heat

- No preheating time is required during Speedcook cycles. The oven begins cooking immediately.
- The door and inside of the oven will be very hot. Use caution when opening the door and removing food.
- Do not use cookware or coverings made of paper, plastic, or foil when cooking during a speedcook cycle.
- When cooking for an extended period of time, the oven may automatically reduce the power levels to maintain the appropriate level of oven heat.

Sounds

- Clicks and a fan blowing are normal sounds during cooking. The relay board is turning components on and off.

Baking, Broiling and Toasting

Advantium Oven

Baking, Broiling and Toasting

Baking allows you to cook foods the same way as a conventional oven, using a heating element to raise the temperature of the air inside the oven. Any oven temperature from 250°F to 450°F may be set.

Broiling allows you to broil foods in the same way as a conventional oven.

Toasting allows you to toast foods the same way as a conventional oven.

A fan gently circulates heated air throughout the oven, over and around the food. Because the heated air is kept constantly moving, not permitting a layer of cooler air to develop around the food, some foods cook slightly faster than in regular oven cooking.

Before you begin, make sure the turntable is in place. Use the non-stick metal tray at all times when baking.

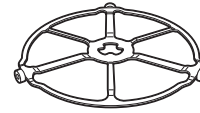

The turntable must always be in place when using the oven.



Put food or oven-safe cookware directly on the non-stick metal tray to bake.

CAUTION! When baking, remember that the oven, door and dishes will be very hot!

¡PRECAUCIÓN! ¡Cuando hornee, recuerde que el horno, compuerta y los platos estarán muy calientes!

How to Bake

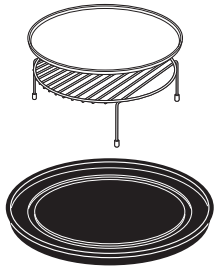

For two-level baking, place food in a metal baking dish or directly on the non-stick metal tray. Place the aluminum baking sheet or your baking dish with food on top of the wire rack. Stand the rack with food on the metal tray.

1. Press the CONV BAKE/BROIL pad.
2. Press the dial to select BAKE.
3. Turn the dial to set the oven temperature and press to enter.

To bypass preheating:

1. When the prompt shows *PREHEAT THE OVEN?* turn the dial to NO. Press the dial or press START/PAUSE to begin cooking.
2. Place the food in the oven, turn the dial to set the cook time and press to enter. The oven starts cooking immediately. When cooking is complete, the oven will signal and turn off.

To preheat:

1. When the prompt shows *PREHEAT THE OVEN?* turn the dial to YES. Press the dial or press START/PAUSE to begin cooking. The oven starts preheating immediately. Do not place the food in the oven. (You will be prompted to enter the cook time, after the oven is preheated.)

2. When the oven is finished preheating, it will signal. If you do not open the door within 1 hour, the oven will turn off automatically. Open the oven door and, using caution, place the food in the oven.
3. Close the oven door. Turn the dial to set the cook time and press to enter and start cooking. When cooking is complete, the oven will signal and turn off.

You may change the oven temperature during preheating by pressing the POWER/TEMP pad and turning the dial to select the new temperature.

If the oven door is opened during cooking, PAUSE will appear in the display. Close the door and press START/PAUSE.

Cook times are shown in minutes and can be a maximum of 179 minutes. Time can be changed during cooking by turning the dial.

How to Broil or Toast



1. Press the CONV BAKE/BROIL pad.
2. Turn the dial to BROIL or TOAST and press to enter.

To bypass preheating:

1. When the prompt shows *PREHEAT THE OVEN?* turn the dial to NO. Press the dial or press START/PAUSE to begin cooking.
2. Place the food in the oven, turn the dial to set the cook time and press to enter. Press the dial to start cooking. When cooking is complete, the oven will signal and turn off.

To preheat:

1. When the prompt shows *PREHEAT THE OVEN?* turn the dial to YES. Press the dial or press START/PAUSE to begin cooking.

The oven starts preheating immediately. Do not place the food in the oven. (You will be prompted to enter the cook time, after the oven is preheated.)

2. When the oven is finished preheating, it will signal. If you do not open the door within 1 hour, the oven will turn off automatically. Open the oven door and, using caution, place the food in the oven.
3. Close the oven door. Turn the dial to set the cook time and press to enter and start cooking. When cooking is complete, the oven will signal and turn off.

If the oven door is opened during cooking, PAUSE will appear in the display. Close the door and press START/PAUSE.

Warming and Proofing

Advantium Oven

Warming

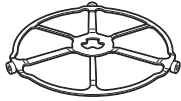

The **turntable** must always be in place when using the oven.



Put food directly on the **non-stick metal tray** to warm.

Tips for Crisp Foods:

- Leave food uncovered.
- Do not use plastic containers or plastic wrap.
- Preheat prior to use according to recommended times.

Tips for Moist Foods:

- Cover food with lid or aluminum foil.
- Do not use plastic containers or plastic wrap.
- Preheat prior to use according to recommended times.

The **WARM** feature will keep hot, cooked foods at serving temperature. Always start with hot food. Use cookware and utensils that can withstand temperatures up to 230°F.

1. Press the WARM/PROOF pad.
2. Turn the dial to select HOLD FOOD WARM. Press the dial to enter.
3. Turn the dial to select the oven temperature. See the chart and tips below. Press the dial to enter.

LOW.....140–160°F
 MEDIUM.....160–195°F
 HIGH.....195–230°F

4. Turn the dial to select the level of moisture you want. See the chart and tips below. Press the dial to enter.

If the oven door is opened during warming, **PAUSE** will appear in the display. Close the door and press **START/PAUSE**.

To Crisp Stale Items:

- Place food or dishes directly on the black metal tray.
- Preheat on LOW setting and select CRISP.
- Check crispness after 45 minutes. Add time as needed.

Temperature and Moisture Selection Chart

Food Type	Control Setting	Moisture Setting
Bread, hard rolls	MEDIUM	CRISP
Bread, soft rolls	MEDIUM	MOIST
Casseroles	MEDIUM	MOIST
Fried foods	HIGH	CRISP
Meats* and fish	MEDIUM	CRISP
Pancakes, waffles	HIGH	CRISP
Pizza	HIGH	CRISP
Potatoes, baked	HIGH	CRISP
Potatoes, mashed	MEDIUM	MOIST
Poultry	HIGH	MOIST
Tortilla Chips	LOW	CRISP
Vegetables	MEDIUM	MOIST

* USDA/FSIS recommends an internal temperature of 145°F as the minimum doneness for beef. Use a portable meat thermometer to check internal temperatures.

Proofing

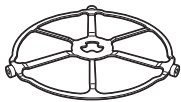

The **turntable** must always be in place when using the oven.



Put bread dough in a bowl/bread pan and place on the **non-stick metal tray** to proof.

The **proofing** feature automatically provides the optimum temperature for the proofing process, and therefore does not have a temperature adjustment.

1. Press the WARM/PROOF pad.
2. Turn the dial to select PROOF BREAD. Press the dial to enter. The oven starts proofing immediately and shows the amount of proofing time completed.

- To avoid lowering the oven temperature and lengthening proofing time, do not open the oven door unnecessarily.
- Check bread products early to avoid over-proofing.

NOTES:

- Do not use the proofing mode for warming food or keeping food hot. The proofing oven temperature is not hot enough to hold foods at safe temperatures. Use the WARM feature to keep food warm.
- Proofing will not operate if the oven is too hot. Allow the oven to cool before proofing.

Microwaving

Advantium Oven

Using the microwave features

Make sure the turntable and clear glass tray are in place. Place food or microwavable container directly on the clear glass tray to cook your food.

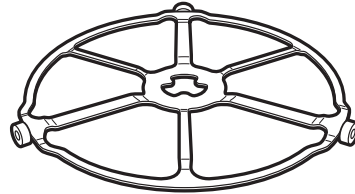

The **turntable** must always be in place when using the oven.

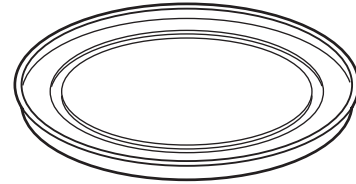

The **clear glass tray** should always be in place when **microwaving**.

Cookware

- Make sure that cookware is suitable for microwaving.
- Place food or microwavable container directly on the clear glass tray to cook your food.

MICROWAVE PRE-SET SELECTIONS:

■ Cook

- By Food Type
- By Time
- By Time 1 & 2
- Delay Start
- Heat/Reheat Beverage
- Melt
- Slow Cook
- Soften

■ Defrost

- 1.0 lb Quick
- By Time
- By Food Type
- By Weight
- Delay Start
- Melt
- Soften

■ Reheat

- Beverage
- Casserole
- Chicken
- Pasta
- Pizza
- Plate of Food
- Rice
- Soup
- Steaks/Chops
- Vegetables

How to use pre-set microwave selections



1. Press the microwave COOK, DEFROST or REHEAT pad.
If no selection is made within 15 seconds, the display will revert back to the time of day.
2. Turn the dial to find the food you want to cook, defrost or reheat. Press the dial to enter.
3. Turn the selector dial to select the type, amount, weight and/or size. (As required, the oven will prompt you.) Press the dial after each selection.
4. Press the dial or the START/ PAUSE pad to start cooking.

To review settings during cooking, press the selector dial.

If the door is opened during cooking, the oven will stop and PAUSE will appear in the display. Close the door and press START/ PAUSE to resume cooking.

If you enter an undesired selection at any time, simply press the BACK pad and re-enter the desired selections.

Microwaving

Advantium Oven

Cook By Time and Cook By Time 1 & 2



Use **COOK BY TIME** and **COOK BY TIME 1 & 2** to microwave food that is not in the recipe section and at the time(s) you set.

■ The power level is automatically set at high, but you can change it for more flexibility.

1. Press the **COOK** pad.
2. Turn the dial to select **COOK BY TIME** or **COOK BY TIME 1 & 2** and press the dial to enter.
3. Turn the dial to set the cook time and press the dial to enter.

If you selected **COOK BY TIME 1 & 2**, turn the dial to set the second cook time and press the dial to enter.

NOTE: To change the power level if you don't want full power, press the **POWER/TEMP** pad after entering the time(s). Turn the dial to select and press the dial to enter.

4. Press the dial or the **START/ PAUSE** pad to start cooking.

You may open the door during **COOK BY TIME** and **COOK BY TIME 1 & 2** to check the food. Close the door and press **START/PAUSE** to resume cooking.

Express



Press **EXPRESS** repeatedly for 30 second increments of microwave cooking time. Oven starts immediately.

Microwave power level(s)



1. First, follow directions for **COOK BY TIME**, **COOK BY TIME 1 & 2**, **DEFROST BY TIME** or **EXPRESS**.

2. Press the **POWER/TEMP** pad.

3. Turn the dial clockwise to increase and counterclockwise to decrease the power level. Press the dial to enter.

4. Press the dial or the **START/ PAUSE** pad to start cooking.

■ You can change the power level before or during a cooking program.

Here are some examples of uses for various power levels:

High 10: Fish, bacon, vegetables, boiling liquids.

Med-High 7: Gentle cooking of meat and poultry; baking casseroles and reheating.

Medium 5: Slow cooking and tenderizing for stews and less tender cuts of meat.

Low 2 or 3: Defrosting; simmering; delicate sauces.

Warm 1: Keeping food warm; softening butter.

Favorite recipe

See the Favorite recipe sections in the Speedcook section of this book for instructions on how to save, use, change or delete a favorite recipe.

Cooking tips

■ When cooking bacon, layer strips on a plate. Cover each layer with a paper towel.

■ When cooking vegetables, use a microwave-safe casserole or bowl. Cover with a microwave-safe lid or vented plastic wrap.

■ For frozen vegetables, follow the package instructions for adding water.

■ For fresh vegetables, add 2 tablespoons of water for each serving.

Microwaving

Advantium Oven

Defrost by food type

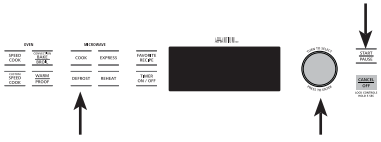

Auto Defrost automatically sets the defrosting times and power levels to give even defrosting results for meats, poultry and fish weighing up to 6 pounds.

1. Remove food from the package and place it on a microwave-safe dish.
2. Press the DEFROST pad.
3. Turn the dial to *DEFROST BY FOOD TYPE*. Press the dial to enter.
4. Turn the dial to select food type. Press the dial to enter.
5. Turn the dial to the food weight, using the Conversion Guide at right. For example, dial 1.2 for 1.2 pounds (1 pound, 3 oz.). Press the dial to enter.
6. Press the dial or START/PAUSE pad to start defrosting.
7. Turn the food over when the oven signals *TURN FOOD OVER*.

- Remove defrosted meat or shield warm areas with small pieces of foil for even defrosting.
- After defrosting, most meats need to stand 5 minutes to complete defrosting. Large roasts should stand for about 30 minutes.

Conversion Guide

If the weight of food is stated in pounds and ounces, the ounces must be converted to tenths (.1) of a pound.

Weight of Food in Ounces	Enter Food Weight (tenths of a pound)
1-2	.1
3	.2
4-5	.3
6-7	.4
8	.5
9-10	.6
11	.7
12-13	.8
14-15	.9

Defrost by time



Use Time Defrost to defrost for a selected length of time.

1. Press the DEFROST pad.
2. Turn the selector dial to *DEFROST BY TIME*. Press the dial to enter.
3. Turn the dial to select the time you want. Press the dial to enter.
4. Press the dial or START/PAUSE pad to start defrosting.
5. Turn the food over when the oven signals *TURN FOOD OVER*.

Power level is automatically set at 3, but can be changed. To change the power levels, see the Microwave Power Level(s) section. You can defrost small items quickly by raising the power level after entering the time. Power level 7 cuts the total defrosting time in about half; power level 10 cuts the total time to about 1/3. When defrosting at high power levels, food will need more frequent attention than usual.

Defrosting tips

Use DEFROST BY FOOD TYPE for meat, poultry and fish. Use DEFROST BY TIME for most other frozen foods.

- Foods frozen in paper or plastic can be time defrosted in the package, but foods should be taken out of the package when using *DEFROST BY FOOD TYPE*. Closed packages should be slit, pierced or vented **after** food has partially defrosted. Plastic storage containers should be partially uncovered.
- Family-size, prepackaged frozen dinners can be defrosted and microwaved. If the food is in a foil container, transfer it to a microwave-safe dish.
- Foods that spoil easily should not be allowed to sit out for more than one hour after defrosting. Room temperature promotes the growth of harmful bacteria.
- For more even defrosting of larger foods, such as roasts, use *DEFROST BY TIME*. Be sure large meats are completely defrosted before cooking.
- When defrosted, food should be cool but softened in all areas. If still slightly icy, return to the microwave very briefly, or let it stand a few minutes.

Microwave sensor cooking

The sensor feature detects the increasing humidity released during cooking. The oven automatically adjusts the cooking time to various types and amounts of food.

Do not use the Sensor Features twice in succession on the same food portion—it may result in severely overcooked or burnt food. If food is undercooked after the first countdown, use **COOK BY TIME** for additional cooking time.

The proper containers and covers are essential for best sensor cooking.

- Always use microwave-safe containers and cover them with lids or vented plastic wrap. Never use tight sealing plastic containers—they can prevent steam from escaping and cause food to overcook.
- Be sure the outside of the cooking containers and the inside of the oven are dry before placing food in the oven. Beads of moisture turning into steam can mislead the sensor.
- Beverages are best heated uncovered.

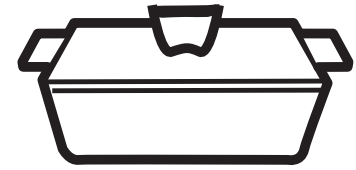

Covered



Vented

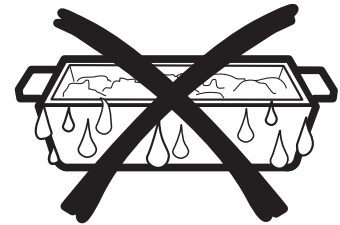

Dry off dishes so they don't mislead the sensor.

MICROWAVE SENSOR PROGRAMS:

- *Ground Meat*
- *Popcorn – Prepackaged microwave popcorn, 3.0 oz. to 3.5 oz.*
- *Soup*
- *Rice*
- *Vegetables (Canned, Fresh, Frozen)*
- *Chicken Reheat*
- *Pasta Reheat*
- *Plate of Food Reheat*
- *Soup Reheat*
- *Vegetable Reheat*

To use all sensor programs



Advantium's microwave mode features sensor cooking. The oven automatically senses when food is done and shuts itself off—eliminating the need to program cook times and power levels.

1. Press the COOK pad and turn the dial to COOK BY FOOD TYPE. Press the dial to enter. Or press the REHEAT pad.
2. Turn the dial to select the food you want. Press the dial to enter.
3. Press the dial or press the START/PAUSE pad to start cooking.

Do not open the oven door until time is counting down in the display. If the door is opened, close it and press START/PAUSE immediately. If the food is not done enough, use *COOK BY TIME* in the microwave selector to cook for more time.

NOTE: Do not use the Sensor Features twice in succession on the same food portion—it may result in severely overcooked or burnt food.

- If you have been speedcooking and the oven is already hot, it may indicate that it is too hot for sensor cooking. Of course, you can always continue with *COOK BY TIME* or *SPEEDCOOK*.

NOTE: If the oven is too hot then it will automatically change to time cooking.

- To shorten or lengthen the cook time, wait until the time countdown shows in the display. Then turn the dial to add or subtract time.
- If you open the door while *SENSOR Cooking*, *SENSOR ERROR* will appear. Close the door, press START/PAUSE to begin again.

Notes about the Reheat program:

Reheated foods may have wide variations in temperature. Some areas may be extremely hot.

It is best to use *COOK BY TIME* and not *REHEAT* for these foods:

- Bread products
- Food that must be reheated uncovered.
- Foods that need to be stirred or turned.
- Foods calling for a dry look or crisp surface after reheating.

Things that are normal

Interference

- TV/radio interference might be noticed while using the microwave. Similar to the interference caused by other small appliances, it does not indicate a problem with the microwave. Move the radio or TV as far away from the microwave as possible, or check the position of the TV/radio antenna.

Lights

- The oven cavity light will come on during a microwave cooking cycle.

Oven Heat

- Cookware may become hot because of heat transferred from the heated food. Oven mitts may be needed to handle the cookware.
- Steam or vapor may escape from around the door.

Other Advantium Features

Advantium Oven

“COOK TIME COMPLETED”

To remind you that you have food in the oven, the oven will display *COOK TIME COMPLETED* and beep once a minute until you either open the oven door or press the CANCEL/OFF pad.



Features under the OPTIONS pad



Clock:

The clock must be set before you can use your oven for the first time (see Quick Start for instructions).

1. To change the clock time, press the OPTIONS pad and turn the dial to *CLOCK*. Press the dial to enter.
2. Turn the dial to set hours. Press the dial to enter.
3. Turn the dial to set minutes. Press the dial to enter.
4. Turn the dial to select AM or PM. Press the dial to enter.

Clock Display ON/OFF:

Use this feature to turn your clock display on or off. Press the OPTIONS pad, turn the dial to select *CLOCK DISPLAY ON/OFF*. Turn the dial to select *ON* or *OFF*. Press the dial to enter.

Delay Start:

Delay Start allows you to set the oven to delay cooking up to 24 hours. Press the OPTIONS pad, turn the dial to select *DELAY START* and press the dial to enter. Follow the display directions to set the Delay Start time and feature you wish to delay.

Beeper Volume:

Use this feature to adjust the volume of the beeper. You can even turn it off. Press the OPTIONS pad, turn the dial to select *BEEPER VOLUME*, press the dial to enter, and follow the display directions.

Scroll Speed:

Is the message scroll too slow or too fast? Change it! Press the OPTIONS pad, turn the dial to select *DISPLAY SCROLL SPEED*, press the dial to enter, and follow the display directions.

Reminder:

Use this feature to set an alarm beep to sound at a specific the time of day. Press the OPTIONS pad, turn the dial to *SET/CLEAR REMINDER* and press the dial to enter. Turn the dial to select the hour and press to enter. Turn the dial to select the minute and press to enter. Turn the dial to select AM or PM and press to enter.

To review the setting, turn the dial to *SET/CLEAR REMINDER* and press the dial to enter. Turn the dial to *REVIEW* and press to enter.

To cancel the setting, turn the dial to *SET/CLEAR REMINDER* and press the dial to enter. Turn the dial to *CLEAR* and press to enter.

Review



Use this feature to review the current cooking selections you have set.

Press the selector dial during speedcooking or microwave cooking.

Other Advantium Features

Advantium Oven

Help



Use this feature to find out more about your oven and its features.

The display will show a description for the program you have chosen.

1. Press the HELP pad.
2. Turn the dial to select the feature name. Press the dial to enter.

Features found in the HELP function.

<i>Adding Time</i>	<i>Defrost by Weight</i>	<i>Set Beeper Volume</i>
<i>Back</i>	<i>Delay Start</i>	<i>Set Clock</i>
<i>Bake</i>	<i>Express Cook</i>	<i>Set Display On/Off</i>
<i>Beverage Heat</i>	<i>Favorite Recipe</i>	<i>Set Display Speed</i>
<i>Broil</i>	<i>Help</i>	<i>Set/Clear Reminder</i>
<i>Child Lockout</i>	<i>Hold Food Warm</i>	<i>Slow Cook</i>
<i>Cancel/Off</i>	<i>Options</i>	<i>Soften/Melt</i>
<i>Cook</i>	<i>Power/Temp</i>	<i>Speed Cook</i>
<i>Cook by Time</i>	<i>Proof Bread</i>	<i>Start/Pause</i>
<i>Cook by Food Type</i>	<i>Reheat</i>	<i>Time Cook 1 & 2</i>
<i>Custom Speed Cook</i>	<i>Repeat Last</i>	<i>Timer On/Off</i>
<i>Defrost</i>	<i>Resume</i>	<i>Toast</i>
<i>Defrost by Food Type</i>	<i>Review</i>	<i>Warm/Proof</i>
<i>Defrost by Time</i>	<i>Sensor Cooking</i>	

Other Advantium Features

Advantium Oven

Child lock-out



You may lock the control panel to prevent the oven from being accidentally started or used by children.

Press and hold CANCEL/OFF for 5 seconds to lock and unlock.

When the control panel is locked, *Control is LOCKED* will be displayed briefly anytime a pad or dial is pressed.

Timer



Use this feature anytime you need a general purpose timer. It can even be used while cooking in the oven.

1. Press the TIMER pad.
2. Turn the dial to select the hours. Press the dial to enter.

3. Turn the dial to select the minutes. Press the dial to enter.

To cancel, press TIMER.

Automatic fan

An automatic fan protects the oven from too much heat inside the oven cavity.

It automatically turns on at low speed if it senses too much heat.

The fan will automatically turn off when the internal parts are cool. It may stay on for 30 minutes or more after the oven control is turned off.

Care and Cleaning

Advantium Oven

Helpful hints

An occasional thorough wiping with a solution of baking soda and water keeps the inside fresh.

Be certain the oven control is turned off before cleaning any part of this oven.



How to clean the inside

Clean the inside of the oven often for proper heating performance.

Some spatters can be removed with a paper towel, others may require a warm soapy cloth. Remove greasy spatters with a sudsy cloth, then rinse with a damp cloth.

Do not use abrasive cleaners or sharp utensils on oven walls.

Never use a commercial oven cleaner on any part of your oven.

Do not clean the inside of the oven with metal scouring pads. Pieces can break off the pad, causing electrical shock.

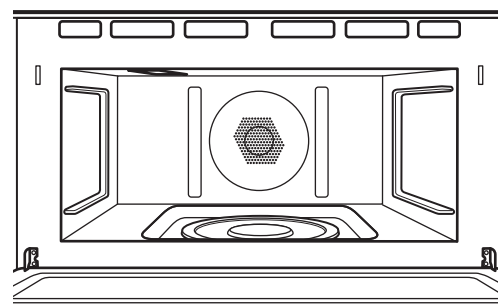

Walls, Floor, Inside Window, Metal and Plastic Parts on the Door

Removable turntable

The area underneath the turntable should be cleaned frequently to avoid odors and smoking during a cooking cycle.

The turntable can be broken if dropped. Wash carefully in warm, sudsy water. Dry completely and replace.

To replace the turntable, place its center over the spindle in the center of the oven and turn it until it seats into place. (Make sure the smooth side of the turntable is facing up and that its center seats securely on the spindle.)

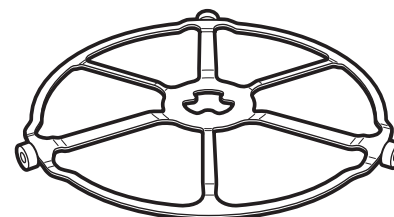

Turntable

Do not use the oven without the turntable in place.

Care and Cleaning

Advantium Oven

Cooking trays and baking sheet

To prevent breakage, allow the trays to cool completely before cleaning. Wash carefully in warm, sudsy water or in the dishwasher.

Do not use metal scouring pads or abrasives, as they may damage the finish. A soap-filled scouring pad may be used to clean the trays.

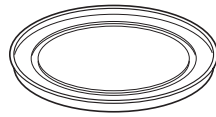

Clear glass tray for microwaving



Non-stick metal tray for speedcooking

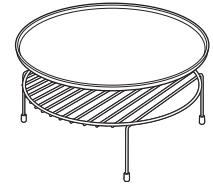

Put food directly on the aluminum baking sheet on the wire oven rack, and place them on the non-stick metal tray, when baking on two levels, broiling or toasting foods.

How to clean the outside

We recommend against using cleaners with ammonia or alcohol, as they can damage the appearance of the oven. If you choose to use a common household cleaner, first apply the cleaner directly to a clean cloth, then wipe the soiled area.

Case

Clean the outside with a sudsy cloth. Rinse and then dry. Wipe the window clean with a damp cloth.

Glass Control Panel and Door

Wipe with a clean damp sponge. Dry thoroughly. Do not use cleaning sprays, large amounts of soap and water, abrasives or sharp objects on the panel—they can damage it.

Door Seal

It's important to keep the area clean where the door seals against the oven. Use only mild, non-abrasive detergents applied with a clean sponge or soft cloth. Rinse well.

Stainless steel (on some models)

To clean the stainless steel surface, use warm sudsy water or a stainless steel cleaner or polish. Always wipe the surface in the direction of the grain. Follow the cleaner instructions for cleaning the stainless steel surface.

To inquire about purchasing stainless steel appliance cleaner or polish, or to find the location of a dealer nearest you, please call our toll-free number, 800.626.2002 or visit GEAppliances.com.

Troubleshooting

Advantium Oven

*Questions?
Use this
problem
solver*

Problem	Possible Causes	What To Do/Explanation
LIGHTS		
Light during a speedcook cycle dims and cycles on and off, even at full power levels	This is normal. Power level has been automatically reduced because the oven is hot.	<ul style="list-style-type: none"> This is normal. The oven senses the heat level and adjusts automatically.
Light visible around the door and outer case while speedcooking	This is normal.	<ul style="list-style-type: none"> When the oven is on, light may be visible around the door and outer case.
FAN		
Fan continues to run after cooking stops	The oven is cooling.	<ul style="list-style-type: none"> The fan will automatically shut off when the internal parts of the oven have cooled.
Oven vent emits warm air while oven is on	This is normal.	
Fan comes on automatically when using the microwave	This is normal.	
COOKING		
The oven makes unusual sounds while cooking	Clicks and fans blowing are normal. The relay board is turning the components on and off.	<ul style="list-style-type: none"> These sounds are normal.
Smoke comes out of the oven when I open the door	Food is high in fat content. Aerosol spray used on the pans.	<ul style="list-style-type: none"> Smoke is normal when cooking high-fat foods.
Food is not fully cooked or browned at the end of a cooking program	Programmed times may not match the size or amount of food you are cooking.	<ul style="list-style-type: none"> Adjust time for doneness or adjust the upper or lower lamps for browning and doneness.
SENSOR ERROR displayed along with an oven signal	Food amount or type placed in the oven does not match the program that was set.	<ul style="list-style-type: none"> Press the CANCEL/OFF pad. Set the oven program to match the food or liquid to be cooked or heated.
	Steam was not sensed by the oven because plastic wrap was not vented, a lid too tight was on the dish or a liquid was covered.	<ul style="list-style-type: none"> Vent plastic wrap, use a looser lid or uncover liquids when cooking or heating.

Troubleshooting

Advantium Oven

*Questions?
Use this
problem
solver*

Problem	Possible Causes	What To Do/Explanation
DISPLAY		
The display is blank	The clock display has been turned off.	<ul style="list-style-type: none">• Check the OPTIONS menu for clock display settings. Turn the display on.
<i>"Control is LOCKED"</i> appears in display	The control has been locked.	<ul style="list-style-type: none">• Press and hold CANCEL/OFF for 5 seconds to unlock the control.
Control display is lighted yet oven will not start	Clock is not set.	<ul style="list-style-type: none">• Set the clock.
	Door not securely closed.	<ul style="list-style-type: none">• Open the door and close securely.
	START/PAUSE pad not pressed after entering cooking selection.	<ul style="list-style-type: none">• Press START/PAUSE.
	Another selection already entered in oven and CANCEL/OFF pad not pressed to cancel it.	<ul style="list-style-type: none">• Press CANCEL/OFF.
	Size, quantity, or cooking time not entered after final selection.	<ul style="list-style-type: none">• Make sure you have entered cooking time after selecting.
	CANCEL/OFF was pressed accidentally.	<ul style="list-style-type: none">• Reset cooking program and press START/PAUSE.
OTHER PROBLEMS		
The door and inside of the oven feels hot	The heat lamps produce intense heat in a small space.	<ul style="list-style-type: none">• This is normal.• Use oven mitts to remove food when ready.
Oven will not start	A fuse in your home may be blown or the circuit breaker tripped.	<ul style="list-style-type: none">• Replace fuse or reset circuit breaker.

With the purchase of your new Monogram appliance, receive the assurance that if you ever need information or assistance from GE, we'll be there. All you have to do is call—toll-free!

GE Answer Center®

***In the USA:
800.626.2000***

Whatever your question about any Monogram major appliance, GE Answer Center® information service is available to help. Your call—and your question—will be answered promptly and courteously. And you can call any time. GE Answer Center® service is open 24 hours a day, Monday through Saturday.

OR

Visit our Website at: monogram.com

In Canada, call 800.561.3344.

***In-Home
Repair Service***

***In the USA:
800.444.1845***

***In Canada:
800.561.3344***

A GE consumer service professional will provide expert repair service, scheduled at a time that's convenient for you. Many GE Consumer Service company-operated locations offer you service today or tomorrow, or at your convenience (7:00 a.m. to 10:00 p.m. weekdays, 8:00 a.m. to 6:00 p.m. Saturday and Sunday). Our factory-trained technicians know your appliance inside and out—so most repairs can be handled in just one visit.

In Canada: Monday to Friday, 7:00 a.m. to 8:00 p.m. and Saturday, 8:00 a.m. to 5:00 p.m. EDST.

***For Customers With
Special Needs...***

***In the USA:
800.626.2000***

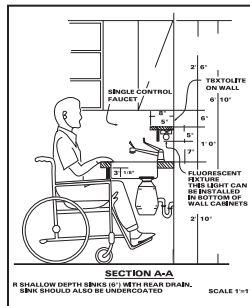

GE offers, free of charge, a brochure to assist in planning a barrier-free kitchen for persons with limited mobility.

Consumers with impaired hearing or speech who have access to a TDD or a conventional teletypewriter may call 800.TDD.GEAC (800.833.4322) to request information or service.

Service Contracts

***In the USA:
800.626.2224***

***In Canada:
800.561.3344***

You can have the secure feeling that GE Consumer Service will still be there after your warranty expires. Purchase a GE contract while your warranty is still in effect and you'll receive a substantial discount. With a multiple-year contract, you're assured of future service at today's prices.

***Parts and
Accessories***

***In the USA:
800.626.2002***

***In Canada:
800.561.3344***

Individuals qualified to service their own appliances can have parts or accessories sent directly to their home. The GE parts system provides access to over 47,000 parts...and all GE Genuine Renewal Parts are fully warranted. VISA, MasterCard and Discover cards are accepted.

User maintenance instructions contained in this manual cover procedures intended to be performed by any user. Other servicing generally should be referred to qualified service personnel. Caution must be exercised, since improper servicing may cause unsafe operation.

Warranty for Customers in the USA

Advantium Oven

YOUR MONOGRAM ADVANTIUM OVEN WARRANTY

Staple sales slip or cancelled check here. Proof of original purchase date is needed to obtain service under warranty.

WHAT IS COVERED

From the Date of the Original Purchase

LIMITED ONE-YEAR WARRANTY

For one year from the date of the original purchase, GE will replace *any part of the microwave oven* which fails due to a defect in materials or workmanship. During this limited one-year warranty, GE will also provide, free of charge, all labor and related service to replace the defective part.

FIVE-YEAR LIMITED WARRANTY

For five years from the date of the original purchase, GE will replace the *magnetron tube*, if the magnetron tube fails due to a defect in materials or workmanship. During this five-year limited warranty, you will be responsible for any labor or in-home service costs.

All warranty service will be provided by our Factory Service Centers or by our authorized Customer Care® servicers during normal working hours.

Should your appliance need service, during warranty period or beyond, in the U.S.A call 800.444.1845.

Please have serial and model numbers available when calling for service.

WHAT IS NOT COVERED

- Service trips to your home to teach you how to use the product.
- Improper installation, delivery or maintenance.
- Product not accessible to provide required service.
- Failure of the product or damage to the product if it is abused, misused (for example, cavity arcing from wire rack or metal/foil), or used for other than the intended purpose or used commercially.
- Replacement of house fuses or resetting of circuit breakers.
- Damage to the product caused by accident, fire, floods or acts of God.
- Incidental or consequential damage caused by possible defects with this appliance.
- Damage caused after delivery.

EXCLUSION OF IMPLIED WARRANTIES—Your sole and exclusive remedy is product repair as provided in this Limited Warranty. Any implied warranties, including the implied warranties of merchantability or fitness for a particular purpose, are limited to one year or the shortest period allowed by law.

This warranty is extended to the original purchaser and any succeeding owner for products purchased for home use within the USA. If the product is located in an area where service by a GE Authorized Servicer is not available, you may be responsible for a trip charge or you may be required to bring the product to an Authorized GE Service Location for service. In Alaska, the warranty excludes the service calls to your home.

Some states do not allow the exclusion or limitation of incidental or consequential damages, so the above limitation or exclusion may not apply to you. This warranty gives you specific legal rights, and you may also have other rights which vary from state to state. To know what your legal rights are in your state, consult your local or state consumer affairs office or your state's Attorney General.

Warrantor: General Electric Company, Louisville, KY 40225



GE Consumer & Industrial
Appliances
General Electric Company
Louisville, KY 40225
monogram.com