

30" Series 9 Classic 4 Burner Dual Fuel Self-Cleaning Range

Classic



Get the best of both worlds with dual fuel. A gas cooktop with wok burner is paired with a convection oven with 9 functions.

- Four burner gas cooktop with two dual wok burners
- Convection oven with 3.5 cu.ft total capacity and nine oven functions including Roast, Aero Pastry™ with pizza mode and rapid proof for baking bread
- Non-tip full-extension shelves for safe removal of hot dishes
- High-temperature self-cleaning function breaks down food residue for an easy clean

DIMENSIONS

Height	35 3/4 - 37 5/8 "
Width	29 7/8 "
Depth	25 1/4 "

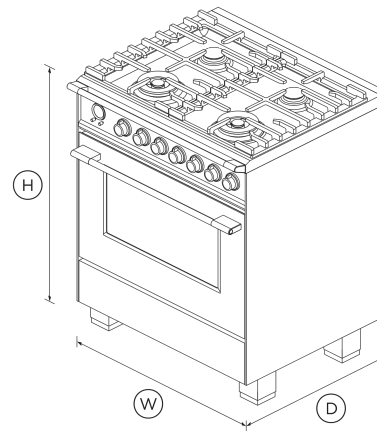

FEATURES & BENEFITS

Multi-Shelf Cooking

Our AeroTech™ system circulates air evenly throughout the entire oven so dishes on the top shelf turn out just as perfect as food cooking on the bottom shelf.

Quality and durability

Every detail has been carefully crafted. The solid, perfectly balanced soft-close door, durable cooktop grates and glowing halo dials all add up to an exceptional, premium range.

Easy To Clean

Cleaning up spills is effortless. Your cooktop simply needs a quick wipe to keep it looking good as new. The self-clean function breaks down food residue at a very high temperature, leaving a light ash that's easily removed with a damp cloth.

Burner power & control

Instant and immediate control from the highest to the gentlest heat. The finely tuned cooktop controls let you sear, stir fry or simmer a delicate sauce to perfection.

Large Capacity Oven

The generous 3.5 cu.ft total capacity oven gives you plenty of space to cook multiple dishes at once, with enough room to fit a 26 lb turkey.

Even heat

Accurate, electronically-controlled oven heat ensures a great result every time.

SPECIFICATIONS

Accessories (included)

2-pc grill system (Broil pan and Grill rack)	•
Broil pan	•
Full extension telescopic shelves	2 sets (part 578776)
Small pot support	1 (part 533981 cast)

Accessories (sold separately)

Hob rear trim	3 1/8" (part 84656)
Kick strip, black (optional)	KICKOR30B1
Kick strip, red (optional)	KICKOR30R1

Kick strip, stainless steel (optional)	KICKOR90X1
Kick strip, white (optional)	KICKOR30W1

Burner ratings

Dual wok burner inner/outer (LPG)	1000 - 18000BTU
Dual wok burner inner/outer (natural gas)	1000 - 18000BTU
Maximum burner power	18000 BTU
Semi-rapid burner (LPG)	1500 - 7600BTU
Semi-rapid burner (natural gas)	1500 - 8000BTU
Total cooktop power	52000 BTU

Capacity

Shelf positions	7
Total capacity	3.5 cu ft
Usable capacity	2.9 cu ft

Cleaning

- Acid resistant graphite enamel •
- Drop down broil element •
- Drop down grill element •
- Flat easy clean glass surface •
- Pyrolytic proof shelf runners •
- Pyrolytic self-clean •
- Removable oven door •
- Removable shelf runners •

Controls

- Audio feedback •
- Automatic cooking/minute timer •
- Automatic pre-set temperatures •
- Celsius/Fahrenheit temperature •
- Electronic clock •
- High resolution display •
- Laser etched graphics •
- Precise electronic temperature control •
- Sabbath mode •
- Turned stainless steel clock buttons •

Gas Requirements

Supply Pressure (LPG)	11" W.C.P
Supply Pressure (natural gas)	4" W.C.P

Oven features

- AeroTech™ technology •
- Auto re-ignition system •
- Automatic rapid pre-heat •
- Bright chromed, cast zinc dials with illuminated halos •
- Concealed element •
- Electronic oven control •
- Full extension telescopic sliding shelves •
- Soft open/close door •
- True convection •
- Turned stainless steel clock dial •

Oven functions

- Aero™ Bake •
- Aero™ Pastry with Pizza mode •
- Number of functions **9**
- Rapid proof •
- Roast •
- True convection •

Oven performance

Broil power	4050 W
CoolTouch door	Triple glazed
Warming drawer power	220 W

Power Requirements

Connection	4-prong grounding type [NEMA 14-50P plug]
Service	40 A
Supply frequency	60 Hz
Supply voltage	208 - 240 V

Product Dimensions

Depth	25 1/4 "
Height	35 3/4 - 37 5/8 "
Width	29 7/8 "

Rangetop features

- Brass burner spreader (power burner) •
- Embossed brass burner cap (power burner) •

- Hob rail
- LPG / Natural Gas compatible
- Sealed range top

- [↓](#) Installation Guide (Canadian French)
- [↓](#) Revit
- [↓](#) Rhino
- [↓](#) Right To Repair Declaration (English, Canadian French)
- [↓](#) SketchUp
- [↓](#) User Guide (English)

Safety

- ADA compliant
- Advanced cooling system
- Anti-tilt bracket
- Balanced oven door
- Catalytic venting system
- Full extension telescopic sliding shelves
- Non-tip shelves
- Spill containment **45.42 L**
- Spill containment **1/2 gallon**

Where applicable:

All appliances use energy, and energy usage typically generates carbon emissions. **Fisher & Paykel Appliances' In-use Energy Carbon Emissions Estimate** indicates carbon emissions from a product's in-use energy. This is calculated either annually or per cycle, using the product's market-specific energy label energy consumption data multiplied by the carbon emissions factor for energy in your country or region.

Our In-use Energy Carbon Emissions Estimate is designed to assist customers in making informed purchasing decisions when comparing different Fisher & Paykel products. For example, a heat pump dryer typically has a lower In-use Energy Carbon Emissions Estimate than a vented dryer.

SKU 81718



A PEACE OF MIND SALE
24 Hours 7 Days a Week Customer Support
 T 1.888.936.7872 W www.fisherpaykel.com

The product dimensions and specifications in this page apply to the specific product and model. Under our policy of continuous improvement, these dimensions and specifications may change at any time. You should therefore check with Fisher & Paykel's Customer Care Centre to ensure this page correctly describes the model currently available. © Fisher & Paykel Appliances Ltd 2020

Other product downloads available at fisherpaykel.com

- [↓](#) DWG
- [↓](#) DXF
- [↓](#) Data Sheet (English)
- [↓](#) Installation Guide (English)