



**LG Digital Signage**  
(MONITOR SIGNAGE)

**Affichage dynamique numérique LG**  
(AFFICHAGE SUR MONITEUR)

**Señalización digital LG**  
(MONITOR DE SEÑALIZACIÓN)

49XE4P-B

55XE4P-B

**ENGLISH Quick Setup Guide**

Please read this manual carefully before operating your set and retain it for future reference.

**FRANÇAIS Guide de configuration rapide**

Veuillez lire le présent manuel attentivement avant d'utiliser l'appareil et conservez-le pour pouvoir vous y reporter ultérieurement.

**ESPAÑOL Guía de instalación rápida**

Lea atentamente este manual antes de poner en funcionamiento el equipo y consérvelo para futuras consultas.

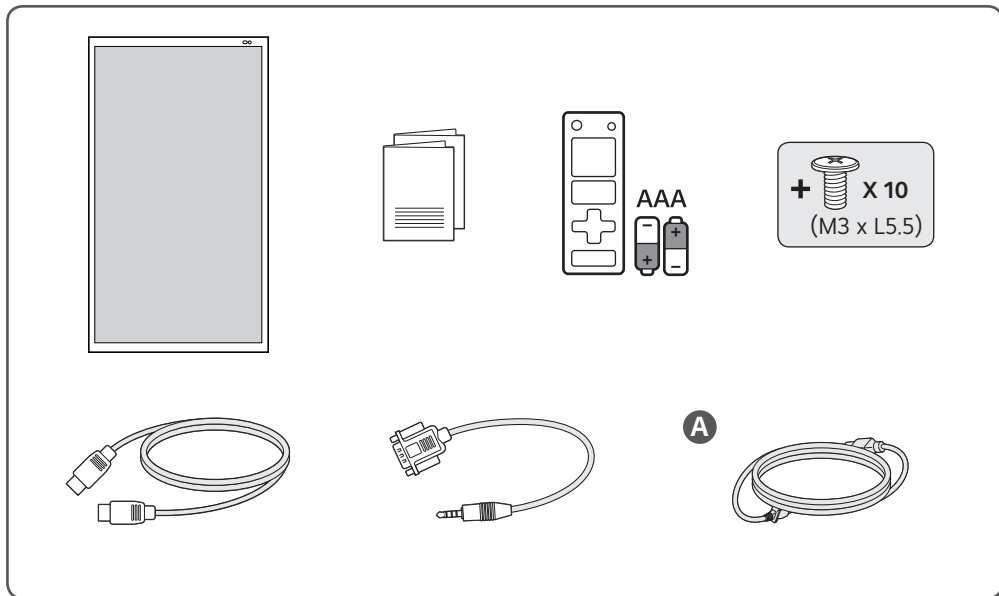

+ Depending upon country / Selon le pays / Según el país

Printed in Korea / Imprimé en Corée

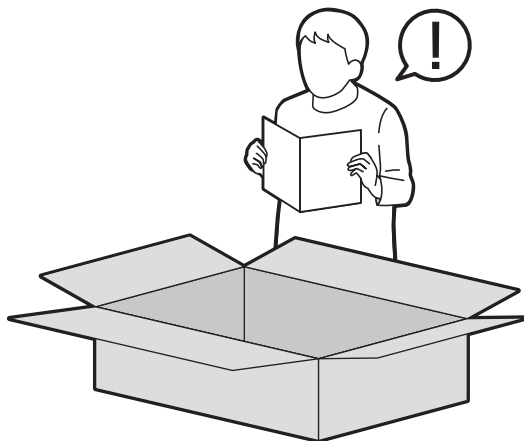

- ▶ [www.lg.com/id-manual](http://www.lg.com/id-manual)
- ▶ SuperSign : <http://partner.lge.com>



#### ENGLISH

- A readily accessible disconnect device shall be incorporated external to the product.
- The components complied with the requirements of IEC 61643-series shall be installed internal or external to this product.

#### FRANÇAIS

- Un périphérique de déconnexion facilement accessible doit être incorporé au produit en externe.
- Les composants conformes aux exigences de la série IEC 61643 doivent être installés avec ce produit, en interne ou en externe.

#### ESPAÑOL

- Los dispositivos de desconexión disponibles deberán incorporarse al producto de forma externa.
- Los componentes que cumplan con los requisitos de la serie IEC 61643 deberán instalarse en este producto de forma interna o externa.

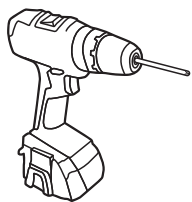
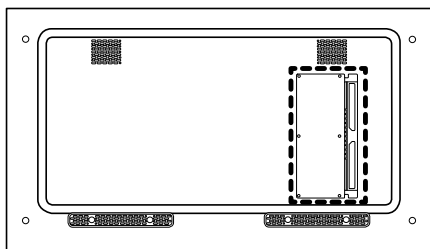

1

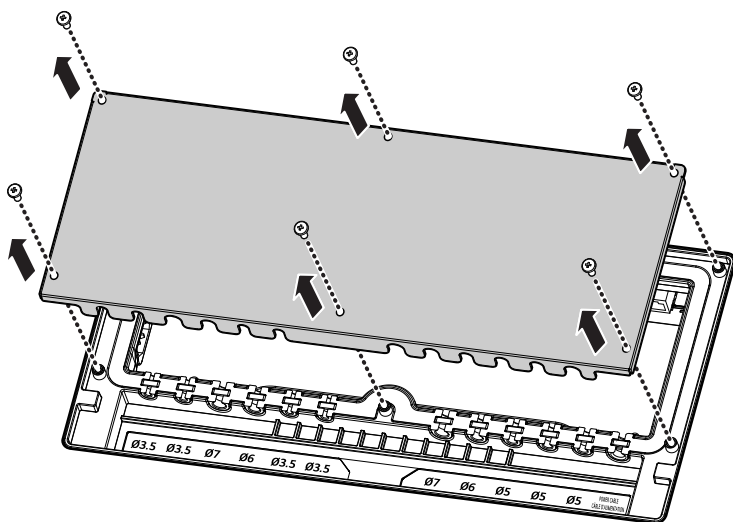



2

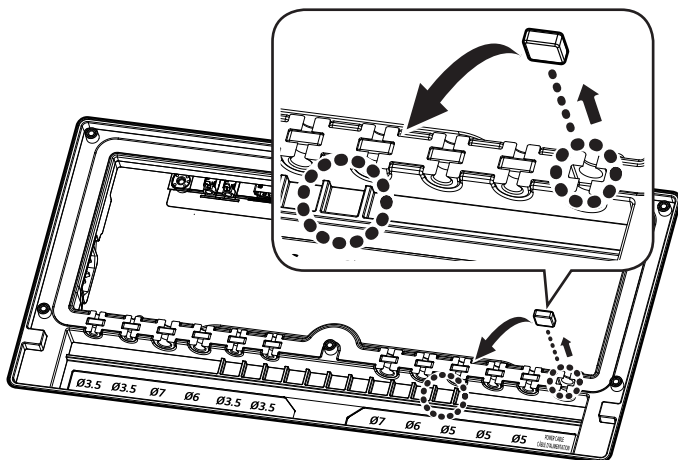

3

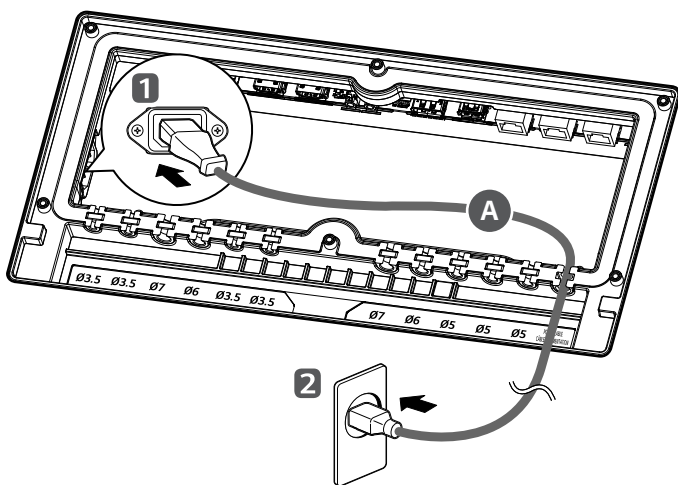



4

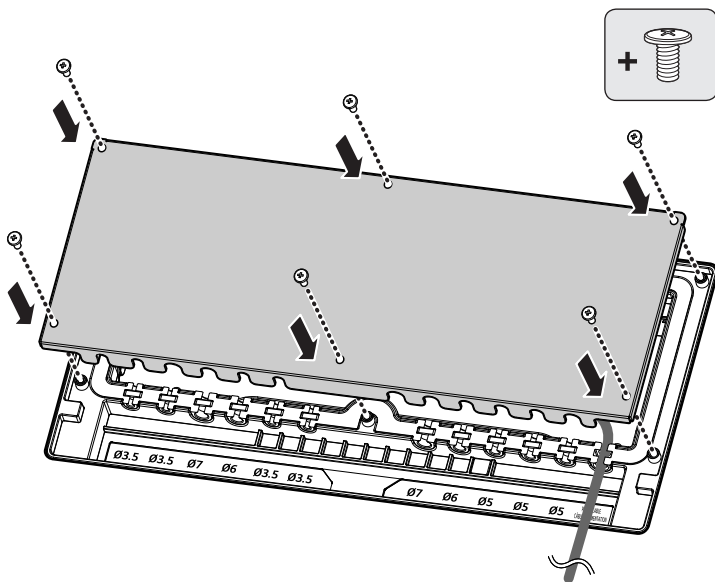







\* M F L 0 5 7 8 3 8 0 2 \*

(2505-REV00)

