



LG EASY GUIDE

NOTEBOOK

15Z95U/15ZB95U/15ZS95U Series

Instruction/Safety Information

Using LG Easy Guide, LG Troubleshooting

LG Electronics Inc. provides LG Easy Guide (User's Guide) and LG Troubleshooting (Troubleshooting Guide) to users for their easy and convenient use of the product.

- Select the Start button [] > [All] and run [LG Easy Guide] or [LG Troubleshooting].

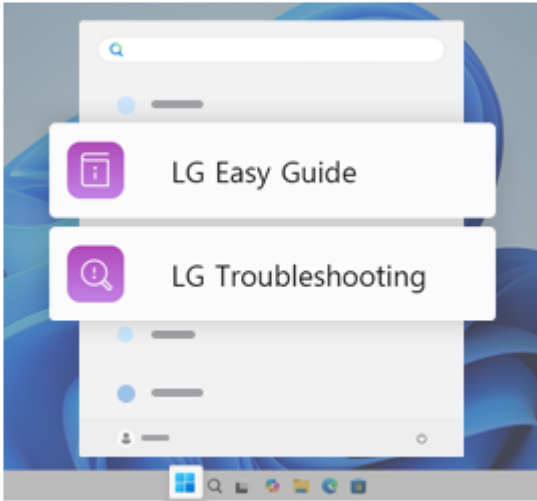

Information/Precautions Before Using

Before reading LG Easy Guide, first check the following information.

- This LG Easy Guide has been written for the Windows 11 operating system.
- The screen and menu configurations may differ from this manual depending on the status of the Windows and software update.
- Representative images are used in LG Easy Guide. Product purchased may differ in appearance and color.
- LG Easy Guide includes instruction about optional products. There may be information about products you did not purchase.
- The contents of LG Easy Guide are subject to change without prior notice.
- Use, duplication, or reproduction of any part of LG Easy Guide without prior permission from LG Electronics Inc. is strictly prohibited.
- LG Electronics Inc. does not provide warranty for data loss. In order to minimize damage from data loss, please make backup copies of important data.
- The optical disk drive (DVD, CD-ROM, etc.) is optional and may not be provided upon purchasing the product.

Safety Precaution Notations

The below symbols are to inform you of dangers and safety concerns that you must be aware of. Read the symbol-indicated instructions with caution to avoid any possible mishap.

**Warning:**

Appears in the case of noncompliance with the instruction that may cause serious physical damage or fatal injuries.

**Caution:**

Appears in the case of noncompliance with the instruction that may cause minor damage to the body or the machine.

Text Notations

The symbols below are used to display information required to use the product. Familiarize yourself with the instructions marked by the symbols to ensure proper operation of the product.

**Tip:**

Indicates that the following information is added to help the user utilize the machine more conveniently.

**Option:**

The Option symbol indicates that the concerned device is not included in the product package and thus has to be purchased separately, or the device may not be applied to the user's machine depending on model type.

Manufacturer and Copyright

Manufacturer and Copyright represent the logo and trademark of the manufacturer, and bear no relationship to the functions supported by the product.

- Microsoft™, MS™, WinPE™, and Windows® are the registered trademarks of Microsoft Corporation™.
- USB Type-C® and USB-C® are registered trademarks of USB Implementers Forum. USB 2.0 Type-C™ is a trademark of USB Implementers Forum.
- Manufactured under license from Dolby Laboratories. Dolby, Dolby Atmos and the double-D symbol are registered trademarks of Dolby Laboratories Licensing Corporation.
- NVMe™ is a trademark of NVM Express, Inc
- Wi-Fi® is a registered trademark of Wi-Fi Alliance Corporation.
- The Bluetooth® word mark and logos are registered trademarks owned by the Bluetooth SIG, Inc. and any use of such marks by LG Electronics is under license. Other trademarks and trade names are those of their respective owners.
- Google, Android, Google Play, Google Play logo, and other marks are the trademarks of Google LLC.
- iPhone is the trademark of Apple Inc. registered in U.S.A. and other countries. App Store is the service mark of Apple Inc.
- DisplayPort™ and DisplayPort™ logo are trademarks owned by the Video Electronics Standards Association (VESA®) in the United States and other countries.



LG logo is a registered trademark of LG Electronics Inc.



The terms HDMI, HDMI High-Definition Multimedia Interface, HDMI Trade Dress and the HDMI Logos are trademarks or registered trademarks of HDMI Licensing Administrator, Inc.



LG Easy Guide may contain undetectable errors despite our dedicated efforts to provide users with reliable information. We ask for your understanding.

The illustrated figures in LG Easy Guide may differ in appearance with the actual products.

Unauthorized reproduction or duplication of any part of LG Easy Guide is strictly prohibited.

LG Electronics Inc. reserves the right to modify any part of this manual for quality purposes, without prior notice.

Copyright © 2026 LG Electronics Inc. ITC Co., LTD

Open Source Software Notice Information

To obtain the source code that is contained in this product, under GPL, LGPL, MPL, and other open source licenses that have the obligation to disclose source code, and to access all referred license terms, copyright notices and other relevant documents please visit <https://opensource.lge.com>.

LG Electronics will also provide open source code to you on CD-ROM for a charge covering the cost of performing such distribution (such as the cost of media, shipping, and handling) upon email request to opensource@lge.com.

This offer is valid to anyone in receipt of this information for a period of three years after our last shipment of this product.

System Protection Feature

If the system becomes too hot, the system protection feature automatically stops recharging and switches the power mode to Hibernate or Off.

The PC system has to cool down before it can be reactivated.

Information on Hard Drive/Memory Capacity

Information on Hard Drive (HDD, SSD, eMMC) Capacity

The hard drive capacity shown by Windows is lower than that stated by the hard drive manufacturer due to a difference in calculation.

Manufacturer	Hard drive manufacturers use a decimal definition of 1 KB = 1,000 Bytes. 100 GB Storage Device (HDD, SSD, eMMC): 100,000 MB / 1,000 Bytes = 100 GB
--------------	--

Windows	Windows use the binary definition of 1 KB = 1,024 Bytes. 100 GB Storage Device (HDD, SSD, eMMC): 100,000 MB / 1,024 Bytes = 97.6 GB
---------	---

RAM Capacity

RAM capacity shown by Windows may be lower than the actual capacity because the PC uses shared memory for BIOS and the integrated graphics card.

Due to BIOS using shared memory, 1,024 MB RAM may be reported as 1,022 MB or slightly less.

If the PC has integrated graphics card, 1,024 MB RAM may be reported as 1,022 MB or less than 1,000 MB.

Symbols

~ Refers to alternating current (AC).

≡ Refers to direct current (DC).

□ Refers to class II equipment.

⏻ Refers to stand-by.

I Refers to "ON" (power).

⚡ Refers to dangerous voltage.

Adjusting Volume (earphone/headphone and speakers)

Before using the earphone/headphone and speakers, check if the volume is too high.

 Caution:



To prevent hearing damage, do not use in high volume for a long term.

Important Safety Precautions

Please use the machine in the proper environment to extend the machine's lifespan. Use the machine in a safe and stable place.

The warranty does not cover any damage resulting from reckless use or use in undesirable environments.

Product Installation/Usage Precautions

 Caution:



Place the machine in a safe place so it does not fall.

- If dropped, the machine may be damaged or cause an injury.
-



Use the product in a clean, dust-free environment.

- Otherwise, the system may not function properly.

6 inches



Do not place any objects within 6 inches of the PC.

- Lack of ventilation may overheat the PC from inside and put users at risk of burn injuries.



Do not store or use the PC near a magnetic object (i.e. a bag with a magnetic object, a diary, a wallet, a memo board, high-powered speakers, a bracelet, or etc.).

- Otherwise, the storage device (HDD, SSD, eMMC) and the system may be damaged, and the system may fail to operate properly.

Do not use the PC on a bag with magnetic objects attached to it.

- Otherwise, the storage device and the system may be damaged, and the system may fail to operate properly.



Operate the product where there is no electromagnetic interference.

- Keep a proper distance between the PC and electronic appliances such as radios or speakers that generate strong magnetic fields.
- Otherwise, data may be lost from the storage device (HDD, SSD, eMMC) or the screen color may be damaged.



Do not connect a key-phone line to a wired LAN port.

- A fire may occur or the product may get damaged.



If the screen is damaged, do not touch it with your hands.

- Contact the call center as it may cause an injury.



Be careful not to pinch your fingers in the connecting (hinge) part of the PC when opening or closing the PC, as it may lead to injury.

- This may lead to bodily injury.

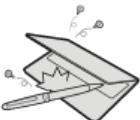

Do not leave any objects such as a pen between the keyboard and the screen.

- You might break the screen by unwittingly closing the PC with a foreign object remaining on the keyboard.



Do not tap or scratch the screen with a sharp object.

- It may cause impairment.



Ensure the power is off before closing the PC.

- The product may catch fire, be broken or deformed due to temperature rise.



Do not impose excessive force on the screen or drop it.

- The screen may be damaged.



Do not lean the screen backward too much. Do not apply too much force to the screen.

- The screen or the moving parts may be damaged.

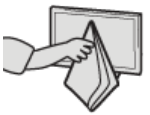

To clean the screen, use designated agents and soft cloth and rub the screen in one direction.

- Too much force may damage the screen.



When handling PC parts, follow the instructions in the manual.

- Otherwise, the product may get damaged.



Install a vaccine program on your PC and do not download illegal programs nor access any corruptive web site such as those pushing pornographic contents.

- The system may be infected and impaired.

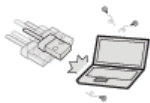

Do not insert devices other than designated ones in the ports.

- Otherwise, the product may get damaged.

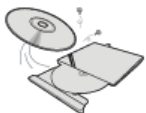

Do not press the eject button while the optical disk drive (CD/DVD/Blu-ray) is running.

- An error may occur or the disc may be ejected, causing injury.



Do not use a damaged optical disc (CD/DVD/Blu-ray).

- Otherwise, the product may get damaged or cause physical injury.



Avoid using a wireless LAN connection within the 16 foot radius of a microwave or plasma lamp. If you have to use wireless LAN and a plasma bulb within the range, do so between channels 11 and 13.

- The transmission rate may drop even if the connection is made.



Turn off the PC if you are not going to use it for an extended period of time.

- It may overheat the battery.

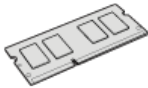

Make sure that the memory cover is securely closed before turning on the PC.

- Do not use the machine when the memory cover is open. It may damage the machine.



Please use parts certified by LG Electronics Inc.

- Otherwise, a fire or product damage may occur.



If there is a problem with peripheral devices, contact the call center.

- The product may get damaged.



Handle devices and parts of the machine with care.

- The product may get damaged.



Do not drop any part or device of the machine while disassembling it.

- If dropped, it may be damaged and cause an injury.



Warning:



Dispose of the desiccating agent and plastic wrap properly.

- The desiccating agent and plastic wrap may cause suffocation.



Do not use the machine in damp places like a laundry room or bathroom.

- Moisture may cause a glitch or electric shock.
- Please use the machine within the appropriate temperature range (50 °F to 95 °F) and humidity range (20 % RH to 80 % RH).



Use a dedicated cleaning agent when cleaning the PC.

Use a small amount of the dedicated cleaning agent on a clean microfiber cloth to clean the exterior surface of the product, and make sure it is completely dry before using it again.

- If the PC is wet while used, an electric shock or fire may occur.



When lightning flashes in your area, disconnect the power, wired LAN and other connections.

- An electric shock or fire may occur.



Do not leave a cup or other containers filled with watery substance near the PC.

- In the case that liquid goes inside the PC, a fire or electric shock may occur.



If you have dropped or damaged the PC, disconnect the power and contact the call center for a safety check.

- If a damaged PC is used continuously, an electric shock or fire may occur.



Do not put a lit candle or live cigarette on the PC.

- A fire may occur.



If you detect or smell smoke from the PC, stop use immediately and disconnect the power source before contacting the call center.

- A fire may occur.



As the adapter can be hot, do not touch it with bare skin while using it.

- Extended period of exposure may cause burn.



The bottom of the PC gets hot when the system is in operation. Do not touch or put it on your lap.

- Extended period of exposure may cause burn.



Do not play PC games excessively.

- Playing a PC game for an extended period of time may cause a mental disorder. It may also inflict physical impairments on the elderly and children.



Do not put your finger or an object into PC ports.

- An injury or electric shock may occur.



Ask one of our engineers to run a safety check after your computer has been repaired.

- Otherwise, an electric shock or fire may occur.



For minors, we recommend a program that blocks access to illegal or pornographic web sites.

- Minors' exposure to adult-only contents may inflict psychological instability or even trauma. Take extra precaution for your children if the whole family is using this machine.



Keep the machine away from heat-emitting devices such as a heater.

- The product may get deformed or catch on fire.



Prevent children from thrusting their finger into the optical disk drive (CD/DVD/Blu-ray) tray.

- The finger may be stuck in the tray and injured.

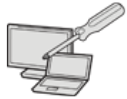

Do not block the ventilation hole with any object.

- Otherwise, an electric shock may occur.



When upgrading your PC, turn off the power and disconnect the power cable, battery, and LAN.

- There is a risk of electric shock or fire and the product may be damaged.



When you upgrade the PC, ensure that children will not swallow any parts including bolts.

- If a child swallows a nut, he or she may suffocate.
- In that case, seek emergency help immediately.



Do not disassemble or modify the machine arbitrarily.

- There is a risk of electric shock and the product may be no longer covered by the warranty.



If you disassemble the PC, connect the power after reassembly is done.

- There is a risk of electric shock or product damage, if you touch the disassembled PC.



Do not put in metal items such as coins, hair pin or other irons or inflammables such as paper or matches. Especially, ensure that children will not do so.

- There is a risk of product damage, fire, or electric shock.
- If any foreign substance gets in the product, unplug the product and contact the call center.

Product Storage/Transportation Precautions



Caution:



Before carrying the machine, turn off the power and disconnect all the cables.

- Otherwise, you may trip over the wire, damaging the PC and sustaining an injury.



- Do not carry the machine with the PC open.
- Otherwise, the product may get damaged.



- Protect the machine from any shock while carrying it.
- System damage or an injury may result.



- Carry the product in a bag designed for it.
- Carrying it in another type of bag may result in product damage.



- Do not put any heavy object on the PC.
- There is the risk of malfunction. If the object were to fall, it may cause an injury or damage the machine.



Warning:



- During air travel, follow the directions of flight attendants.
- Using the PC during flight may cause an aircraft accident.



- When leaving the machine in a car, avoid exposure to direct sunlight.
- The product may get deformed or catch on fire due to a temperature rise.



- Do not put any heavy object on the power cable and adapter, and avoid damage from impacts.
- A malfunction or fire may occur.



- Do not leave the powered-on PC in a space without enough ventilation (i.e. bags) for an extended or repeated time.
- The battery may overheat and cause a fire.

Battery and Adapter Precautions



Warning:

50 %



- When the PC is not used for an extended period of time, keep the battery level at about 50 %.
- Do not leave the product with discharged battery for an extended period of time. It may damage the battery.

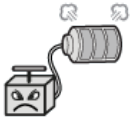

Charge the battery only with the provided instrument.

- Otherwise, the battery may be damaged presenting a risk of fire.



Do not throw or disassemble the battery.

- The resulting damage may cause an injury, explosion, or fire.

Good!



Use batteries certified and acknowledged by LG Electronics Inc.

- Otherwise, an explosion or fire may occur.



Prevent the battery from being in contact with any metallic object like a car ignition key or a paper clip.

- Otherwise, this may cause damage to the battery, a fire or burn due to overheat in the battery.

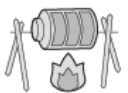

Keep the battery away from heat.

- Otherwise, an explosion or fire may occur.



Do not short-circuit the battery.

- Otherwise, it may explode.



Do not dispose of a spent or backup (standby) battery arbitrarily.

- It may explode or cause a fire.
- Disposal methods may differ by country and region. Dispose of spent batteries in accordance with the laws and safety rules of the country and region you reside in.



If you find leakage or smell bad odor from the battery, remove the battery and contact the call center.

- It may explode or cause a fire.



140 °F

Do not store in places with temperatures above 140 °F and high humidity (in cars or saunas).

- It may explode or cause a fire.

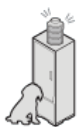

Keep the battery out of the reach of children or pets.

- If damaged, it may cause an injury.



Keep the battery from being pierced by a sharp object or chewed by pets.

- It may explode or cause a fire.



Do not put the battery in water.

- Otherwise, the battery may be damaged or explode.



Do not use the PC on top of carpet, blanket or bed. Also, do not put the adapter under the blanket.

- This may cause a malfunction, fire or burn due to overheat in the PC and adapter.



Read the battery usage precautions carefully before use.

- The battery should be stored indoors and used and stored in accordance with the usage method described in the user manual.



Connect the power plug properly by pushing it to the end.

- If a contact failure occurs, it may cause product damage or fire.



Do not bend the power cable for adapter too much or get stamped by a sharp object.

- The wires inside the cable may break and cause electric shock or fire.



Do not use loose plugs or damaged power cords.

- An electric shock or fire may occur.



Do not touch the power cord with your hands wet.

- Otherwise, an electric shock may occur.



Pull the plug, not the cord, to disconnect the adapter and power jack.

- Otherwise, a fire or product damage may occur.



Operate the product at the proper voltage.

- Excessive voltage may result in damage on the product, electric shock or fire.



Use power outlets with an earth pin installed and proper supply of rated electricity.

- An electric leakage may cause an electric shock or fire.
- The shape of the power cord and outlet may differ by country and region.



In the case of strange noise from the cord or plug, disconnect the power cord from the outlet immediately and contact the call center.

- A fire or electric shock may occur.



Use the power supply/adapter approved by LG Electronics Inc. and never disassemble the product.

- Using a different product or disassembling it may cause an electric shock or fire.



Always keep the adapter and power outlet clean.

- A fire may occur.



Keep children and pets from damaging the power cord.

- It may cause a fire or an electric shock.



Disconnect the PC completely before cleaning it.

- Otherwise, an electric shock or impairment may occur.



If the adapter or the product is soaked, disconnect the battery, adapter, and all other lines before contacting the call center.

- An electric shock or fire may occur.



Ensure that the battery pack is locked to the machine after installation.

- Otherwise, the battery may be damaged.

Other Safety Precautions



Caution:



Handle the machine with care to prevent loss of data from the storage device (HDD, SSD, eMMC).

- Since the storage device is fragile, you need to back up your important data frequently.
- The manufacturer is not responsible for any storage device data loss caused by a user's mistake.



Damage to the storage device (HDD, SSD, eMMC) and data loss may occur when:

- External shocks are inflicted on the machine while disassembling or installing it.
- The machine is reset (i.e. restarted) or turned on again after a power outage while the storage device is operating.



- The PC is infected with a virus, tainting the data irrecoverably.
- Abrupt turning-off of the PC can damage the PC.
- If the product is moved, shaken or exposed to external shock while the storage device is running, file damage or bad sectors may occur.



To minimize data loss resulting from storage device damage (HDD, SSD, eMMC), frequently back up important data.

- The manufacturer is not responsible for any data loss.



We do not refund or replace a product that malfunctions due to the installation or use of an operating system other than the one provided by LG Electronics Inc.

- Some software applications may not work properly in other operating systems. Such malfunctions are not covered by the warranty.

ENERGY STAR®

ENERGY STAR®

ENERGY STAR® Specifications



- LG Electronics Inc. participates in ENERGY STAR® and the energy efficiency of this product complies with the specifications of ENERGY STAR®.
- ENERGY STAR® is a set of regulations that encourages manufacturers of electronic devices to create more energy efficient products.
- The energy consumption of this product was decreased along with the cost. Also, it helps preserve natural resources.
- The PC is set to switch to Modern Standby after 5 minutes of inactivity.
- To leave sleep mode, click a mouse button or press any key on the keyboard.

Power Management Options

The power management options of this PC is configured as follows.



Tip:

The settings of the power management options may be changed upon Windows update.

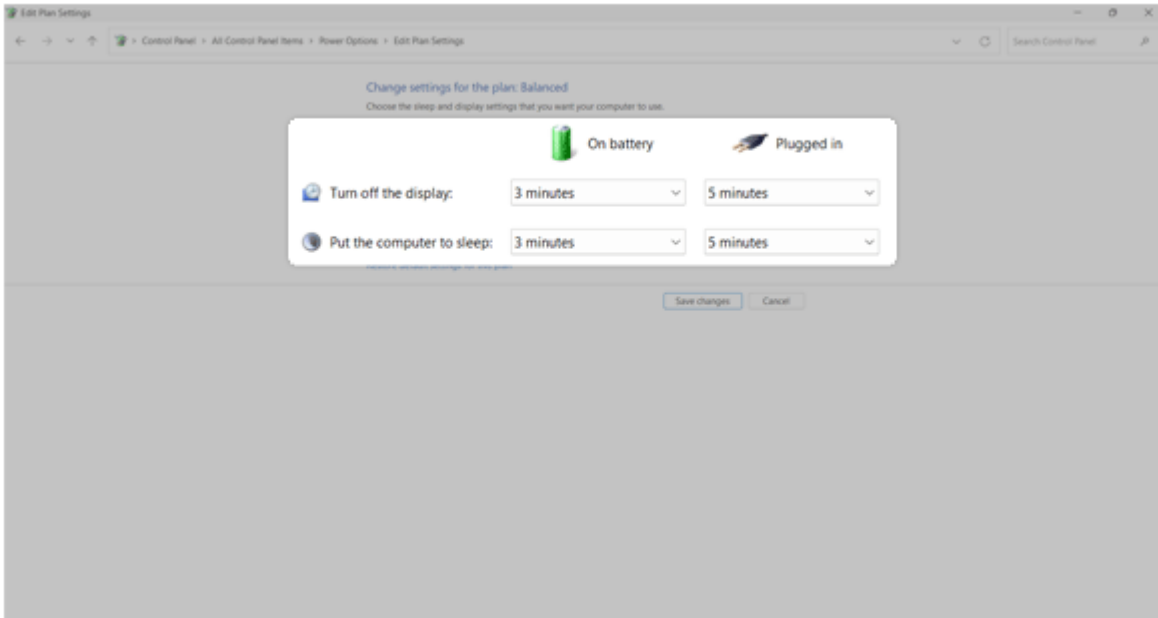

- **Turn off the display:** Turns off the screen when you don't use the PC for a set period of time.



Warning:

The screen is set to never turn off, which uses more power and results in higher carbon emissions.

- **Put the computer to sleep:** Switches to the Sleep mode when you don't use the PC for a set period of time.



Warning:

Sleep is set to Never, which uses more power and results in higher carbon emissions.

Regulatory Notices

UK Notice



ENGLISH

- Hereby, LG Electronics declares that the radio equipment type PC is in compliance with the relevant statutory requirements. The full text of the UK declaration of conformity is available at the following internet address:

<http://www.lg.com/global/support/cedoc/cedoc#>

The use of the 5150-5350 MHz and 5945-6425 MHz band (if applicable) is restricted to indoor use only. This restriction exists in the United Kingdom (UK).

European Union Notice



	AT	BE	BG	CH	CY	CZ	DE	DK
	EE	EL	ES	FI	FR	HR	HU	IE
	IS	IT	LI	LT	LU	LV	MT	NL
	NO	PL	PT	RO	SE	SI	SK	UK(NI)

ENGLISH

- Hereby, LG Electronics declares that the radio equipment type PC is in compliance with Directive 2014/53/EU.

The full text of the EU declaration of conformity is available at the following internet address:

<http://www.lg.com/global/support/cedoc/cedoc#>

The use of the 5150-5350 MHz and 5945-6425 MHz band (if applicable) is restricted to indoor use only.

This restriction exists in Belgium (BE), Bulgaria (BG), Czech Republic (CZ), Denmark (DK), Germany (DE), Estonia (EE), Ireland (IE), Greece (EL), Spain (ES), France (FR), Croatia (HR), Italy (IT), Cyprus (CY), Latvia (LV), Lithuania (LT), Luxembourg (LU), Hungary (HU), Malta (MT), Netherlands (NL), Austria (AT), Poland (PL), Portugal (PT), Romania (RO), Slovenia (SI), Slovakia (SK), Finland (FI), Sweden (SE), Northern Ireland (UK(NI)), Switzerland (CH), Iceland (IS), Liechtenstein (LI) and Norway (NO).

ESPAÑOL

- Por la presente, LG Electronics declara que el tipo de equipo de radio ordenador cumple con la Directiva 2014/53/UE.

El texto completo de la declaración de conformidad con la legislación de la Unión Europea está disponible en el siguiente sitio web:

<http://www.lg.com/global/support/cedoc/cedoc#>

Las bandas de 5150-5350 MHz y 5945-6425 MHz (si procede) solo pueden utilizarse en interiores.

Esta restricción existe en Bélgica (BE), Bulgaria (BG), República Checa (CZ), Dinamarca (DK), Alemania (DE), Estonia (EE), Irlanda (IE), Grecia (EL), España (ES), Francia (FR), Croacia (HR), Italia (IT), Chipre (CY), Letonia (LV), Lituania (LT), Luxemburgo (LU), Hungría (HU), Malta (MT), Países Bajos (NL), Austria (AT), Polonia (PL), Portugal (PT), Rumanía (RO), Eslovenia (SI), Eslovaquia (SK), Finlandia (FI), Suecia (SE), Irlanda del Norte (UK(NI)), Suiza (CH), Islandia (IS), Liechtenstein (LI) y Noruega (NO).

CATALÀ

- Mitjançant aquest escrit, LG Electronics declara que l'equip de ràdio d'aquest ordinador compleix amb la Directiva 2014/53/UE.

El text complet de la declaració de conformitat de la UE està disponible a l'adreça d'Internet següent:

<http://www.lg.com/global/support/cedoc/cedoc#>

L'ús de les bandes de 5150-5350 MHz i 5945-6425 MHz (si escau) està restringit exclusivament a l'ús en interiors. Aquesta restricció existeix a Bèlgica (BE), Bulgària (BG), República Txeca (CZ), Dinamarca (DK), Alemanya (DE), Estònia (EE), Irlanda (IE), Grècia (EL), Espanya (ES), França (FR), Croàcia (HR), Itàlia (IT), Xipre (CY), Letònia (LV), Lituània (LT), Luxemburg (LU), Hongria (HU), Malta (MT), Països Baixos (NL), Àustria (AT), Polònia (PL), Portugal (PT), Romania (RO), Eslovènia (SI), Eslovàquia (SK), Finlàndia (FI), Suècia (SE), Irlanda del Nord (UK(NI)), Suïssa (CH), Islàndia (IS), Liechtenstein (LI) i Noruega (NO).

PORTUGUÊS

- Pela presente, a LG Electronics declara que o computador tipo equipamento de rádio está em conformidade com a Diretiva 2014/53/UE.

O texto integral da declaração de conformidade da UE está disponível no seguinte endereço da Internet:

<http://www.lg.com/global/support/cedoc/cedoc#>

A utilização da banda de 5150-5350 MHz e 5945-6425 MHz (se aplicável) está restrita à utilização em interiores.

Esta restrição existe na Bélgica (BE), Bulgária (BG), República Checa (CZ), Dinamarca (DK), Alemanha (DE), Estónia (EE), Irlanda (IE), Grécia (EL), Espanha (ES), França (FR), Croácia (HR), Itália (IT), Chipre (CY), Letónia (LV), Lituânia (LT), Luxemburgo (LU), Hungria (HU), Malta (MT), Holanda (NL), Áustria (AT), Polónia (PL), Portugal (PT), România (RO), Eslovénia (SI), Eslováquia (SK), Finlândia (FI), Suécia (SE), Irlanda do Norte (UK(NI)), Suíça (CH), Islândia (IS), Liechtenstein (LI) e Noruega (NO).

POLSKI

- Niniejszym firma LG Electronics oświadcza, że komputer wykorzystujący sprzęt radiowy jest zgodny z dyrektywą 2014/53/UE.

Pełny tekst deklaracji zgodności UE jest dostępny pod następującym adresem internetowym:

<http://www.lg.com/global/support/cedoc/cedoc#>

Pasma 5150–5350 MHz i 5945–6425 MHz (jeśli ma zastosowanie) jest ograniczone tylko do użytku wewnątrz pomieszczeń.

Ograniczenie to występuje w Belgii (BE), Bułgarii (BG), Republice Czeskiej (CZ), Danii (DK), Niemczech (DE), Estonii (EE), Irlandii (IE), Grecji (EL), Hiszpanii (ES), Francji (FR), Chorwacji (HR), we Włoszech (IT), na Cyprze (CY), na Łotwie (LV), na Litwie (LT), w Luksemburgu (LU), na Węgrzech (HU), na Malcie (MT), w Holandii (NL), Austrii (AT), Polsce (PL), Portugalii (PT), Rumunii (RO), Słowenii (SI), Słowacji (SK), Finlandii (FI), Szwecji (SE), Irlandii Północnej (UK(NI)), Szwajcarii (CH), na Islandii (IS), w Liechtensteinie (LI) i Norwegii (NO).

ITALIANO

- Con la presente, LG Electronics dichiara che l'apparecchiatura radio tipo PC è conforme con la Direttiva 2014/53/UE.

Il testo completo della Dichiarazione di conformità UE è disponibile al seguente indirizzo Internet:

<http://www.lg.com/global/support/cedoc/cedoc#>

L'uso della banda 5.150-5.350 MHz e 5.945-6.425 MHz (se applicabile) è limitata al solo uso in ambienti interni.

La presente restrizione esiste in Belgio (BE), Bulgaria (BG), Repubblica Ceca (CZ), Danimarca (DK), Germania (DE), Estonia (EE), Irlanda (IE), Grecia (EL), Spagna (ES), Francia (FR), Croazia (HR), Italia (IT), Cipro (CY), Lettonia (LV), Lituania (LT), Lussemburgo (LU), Ungheria (HU), Malta (MT), Paesi Bassi (NL), Austria (AT), Polonia (PL), Portogallo (PT), Romania (RO), Slovenia (SI), Slovacchia (SK), Finlandia (FI), Svezia (SE), Irlanda del Nord (UK(NI)), Svizzera (CH), Islanda (IS), Liechtenstein (LI) e Norvegia (NO).

DEUTSCH

- Hiermit erklärt LG Electronics, dass das Funkgerät vom Typ PC der EU-Richtlinie 2014/53/EU entspricht.

Der vollständige Text der EU-Konformitätserklärung steht zur Verfügung unter folgender Internetadresse:

<http://www.lg.com/global/support/cedoc/cedoc#>

Die Frequenzbänder im Bereich 5150 - 5350 MHz und 5945 - 6425 Mhz (soweit vorhanden) dürfen nur im Innenbereich benutzt werden.

Diese Einschränkung besteht in Belgien (BE), Bulgarien (BG), Tschechien (CZ), Dänemark (DK), Deutschland (DE), Estland (EE), Irland (IE), Griechenland (EL), Spanien (ES), Frankreich (FR), Kroatien (HR), Italien (IT), Zypern (CY), Lettland (LV), Litauen (LT), Luxemburg (LU), Ungarn (HU), Malta (MT), Niederlande (NL), Österreich (AT), Polen (PL), Portugal (PT), Rumänien (RO), Slowenien (SI), Slowakei (SK), Finnland (FI), Schweden (SE), Nordirland (UK(NI)), Schweiz (CH), Island (IS), Liechtenstein (LI) und Norwegen (NO).

MAGYAR

- LG Electronics igazolja, hogy a PC típusú rádióberendezés megfelel a 2014/53/EU irányelvnek.

Az EU-megfelelőségi nyilatkozat teljes szövege elérhető a következő internetes címen:

<http://www.lg.com/global/support/cedoc/cedoc#>

Az 5150-5350 MHz és a 5945-6425 MHz sáv használata (ha alkalmazható) csak beltéri használatra korlátozódik.

Ez a korlátozás Belgiumban (BE), Bulgáriában (BG), a Cseh Köztársaságban (CZ), Dániában (DK), Németországban (DE), Észtországban (EE), Írországon (IE), Görögországban (EL), Spanyolországban (ES), Franciaországban (FR),

Horvátországban (HR), Olaszországban (IT), Cipruson (CY), Lettországban (LV), Litvániában (LT), Luxemburgban (LU), Magyarországon (HU), Máltán (MT), Hollandiában (NL), Ausztriában (AT), Lengyelországban (PL), Portugáliában (PT), Romániában (RO), Szlovéniában (SI), Szlovákiában (SK), Finnországban (FI), Svédországban (SE), Észak-Írországban (UK(NI)), Svájcban (CH), Izlandon (IS), Liechtensteinban (LI) és Norvégiában (NO) érvényes.

NEDERLANDS

- Hierbij verklaar ik, LG Electronics, dat het type radioapparatuur PC conform is met Richtlijn 2014/53/EU.

De volledige tekst van de EU-conformiteitsverklaring kan worden geraadpleegd op het volgende internetadres:

<http://www.lg.com/global/support/cedoc/cedoc#>

De 5150-5350 MHz- en 5945-6425 MHz-band kunnen (indien van toepassing) alleen binnenshuis worden gebruikt.

Deze beperking geldt voor België (BE), Bulgarije (BG), Tsjechië (CZ), Denemarken (DK), Duitsland (DE), Estland (EE), Ierland (IE), Griekenland (EL), Spanje (ES), Frankrijk (FR), Kroatië (HR), Italië (IT), Cyprus (CY), Letland (LV), Litouwen (LT), Luxemburg (LU), Hongarije (HU), Malta (MT), Nederland (NL), Oostenrijk (AT), Polen (PL), Portugal (PT), Roemenië (RO), Slovenië (SI), Slowakije (SK), Finland (FI), Zweden (SE), Noord-Ierland (UK(NI)), Zwitserland (CH), IJsland (IS), Liechtenstein (LI) en Noorwegen (NO).

ROMÂNĂ

- Prin prezenta, LG Electronics declară că tipul de echipamente radio al computerului personal (PC) este în conformitate cu Directiva 2014/53/UE.

Textul integral al declarației UE de conformitate este disponibil la următoarea adresă internet:

<http://www.lg.com/global/support/cedoc/cedoc#>

Utilizarea benzii de 5150 - 5350 MHz și a celei de 5945 - 6425 MHz (dacă este cazul) este restricționată doar la interior.

Aceste restricții există în: Belgia (BE), Bulgaria (BG), Republica Cehă (CZ), Danemarca (DK), Germania (DE), Estonia (EE), Irlanda (IE), Grecia (EL), Spania (ES), Franța (FR), Croația (HR), Italia (IT), Cipru (CY), Letonia (LV), Lituania (LT), Luxemburg (LU), Ungaria (HU), Malta (MT), Olanda (NL), Austria (AT), Polonia (PL), Portugalia (PT), România (RO), Slovenia (SI), Slovacia (SK), Finlanda (FI), Suedia (SE), Irlanda de Nord (UK(NI)), Elveția (CH), Islanda (IS), Liechtenstein (LI) și Norvegia (NO).

FRANÇAIS

- Par la présente, LG Electronics déclare que l'équipement radio de type PC est en conformité avec la Directive 2014/53/EU.

Le texte intégral de la déclaration de conformité UE est disponible à l'adresse suivante:

<http://www.lg.com/global/support/cedoc/cedoc#>

L'utilisation des bandes de fréquences 5 150 - 5 350 MHz et 5 945 - 6 425 MHz (le cas échéant) est limitée à un usage en intérieur.

Cette restriction existe en Belgique (BE), Bulgarie (BG), République Tchèque (CZ), Danemark (DK), Allemagne (DE), Estonie (EE), Irlande (IE), Grèce (EL), Espagne (ES), France (FR), Croatie (HR), Italie (IT), Chypre (CY), Lettonie (LV), Lituanie (LT), Luxembourg (LU), Hongrie (HU), Malte (MT), Pays-Bas (NL), Autriche (AT), Pologne (PL), Portugal (PT), Roumanie (RO), Slovénie (SI), Slovaquie (SK), Finlande (FI), Suède (SE), Irlande du Nord (UK(NI)), Suisse (CH), Islande (IS), Liechtenstein (LI) et Norvège (NO).

DANSK

- Hermed erklærer LG Electronics, at radioudstyrstypen PC er i overensstemmelse med direktiv 2014/53/EU.

Den fulde tekst af EU-overensstemmelseserklæringen er tilgængelig på følgende internetadresse:

<http://www.lg.com/global/support/cedoc/cedoc#>

Brugen af 5150-5350 MHz- og 5945-6425 MHz-båndet er kun forbeholdt indendørs brug.

Denne begrænsning gælder i Belgien (BE), Bulgarien (BG), Tjekkiet (CZ), Danmark (DK), Tyskland (DE), Estland (EE), Irland (IE), Grækenland (EL), Spanien (ES), Frankrig (FR), Kroatien (HR), Italien (IT), Cypern (CY), Letland (LV), Litauen

(LT), Luxembourg (LU), Ungarn (HU), Malta (MT), Holland (NL), Østrig (AT), Polen (PL), Portugal (PT), Rumænien (RO), Slovenien (SI), Slovakiet (SK), Finland (FI), Sverige (SE), Nordirland (UK(NI)), Schweiz (CH), Island (IS), Liechtenstein (LI) og Norge (NO).

SUOMI

- Täten LG Electronics vakuuttaa, että radiolaitetyyppi PC on direktiivin 2014/53/EU mukainen.

Tämän EU-yhdenmukaisuusjulistuksen koko teksti löytyy seuraavasta Internet-osoitteesta:

<http://www.lg.com/global/support/cedoc/cedoc#>

Taajuusalueen 5 150 – 5 350 MHz ja 5 945 – 6 425 MHz (jos sovellettavissa) käyttö on sallittua vain sisätiloissa.

Tämä rajoitus on havaittu Belgia (BE), Bulgaria (BG), Tšekin tasavalta (CZ), Tanska (DK), Saksa (DE), Viro (EE), Irlanti (IE), Kreikka (EL), Espanja (ES), Ranska (FR), Kroatia (HR), Italia (IT), Kypros (CY), Latvia (LV), Liettua (LT), Luxemburg (LU), Unkari (HU), Malta (MT), Alankomaat (NL), Itävalta (AT), Puola (PL), Portugali (PT), Romania (RO), Slovenia (SI), Slovakia (SK), Suomi (FI), Ruotsi (SE), Pohjois-Irlanti (UK(NI)), Sveitsi (CH), Islanti (IS), Liechtenstein (LI) ja Norja (NO).

NORSK

- LG Electronics erklærer herved at radioutstyret av typen PC er i samsvar med Direktiv 2014/53/EU.

Den fullstendige teksten til EU-samsvarserklæringen er tilgjengelig hos følgende internettadresse:

<http://www.lg.com/global/support/cedoc/cedoc#>

Bruken av 5150–5350 MHz og 5945–6425 MHz-båndet (hvis aktuelt) er begrenset til innendørs bruk.

Denne begrensningen finnes i Belgia (BE), Bulgaria (BG), Tsjekkia (CZ), Danmark (DK), Tyskland (DE), Estland (EE), Irland (IE), Hellas (EL), Spania (ES), Frankrike (FR), Kroatia (HR), Italia (IT), Kypros (CY), Latvia (LV), Litauen (LT), Luxembourg (LU), Ungarn (HU), Malta (MT), Nederland (NL), Østerrike (AT), Polen (PL), Portugal (PT), Romania (RO), Slovenia (SI), Slovakia (SK), Finland (FI), Sverige (SE), Nord-Irland (UK(NI)), Sveits (CH), Island (IS), Liechtenstein (LI) og Norge (NO).

SVENSKA

- Härmed intygar LG Electronics att radioutrustningstypen PC är i överensstämmelse med direktiv 2014/53/EU.

Den fullständiga texten av EU-försäkran om överensstämmelse finns på följande Internetadress:

<http://www.lg.com/global/support/cedoc/cedoc#>

5 150 – 5 350 MHz- och 5 945 – 6 425 MHz-bandet får bara användas inomhus.

Denna begränsning existerar i Belgien (BE), Bulgarien (BG), Tjeckiska Republiken (CZ), Danmark (DK), Tyskland (DE), Estland (EE), Irland (IE), Grekland (EL), Spanien (ES), Frankrike (FR), Kroatien (HR), Italien (IT), Cypern (CY), Lettland (LV), Litauen (LT), Luxemburg (LU), Ungern (HU), Malta (MT), Nederländerna (NL), Österrike (AT), Polen (PL), Portugal (PT), Rumänien (RO), Slovenien (SI), Slovakien (SK), Finland (FI), Sverige (SE), Nordirland (UK(NI)), Schweiz (CH), Island (IS), Liechtenstein (LI) och Norge (NO).

CE RF Radiation Exposure Statement:

Caution This equipment complies with European RF radiation exposure limits for SAR (Specific Absorption Rate). This transmitter must not be co-located or operating in conjunction with any other antenna or transmitter.

External Power Supply Information

*An adapter may not be available depending on the model.

1	Manufacturer's name or trade mark, commercial registration number and address	Manufacturer; LG Electronics Inc. Commercial registration number; 107-86-14075 Address; LG Twin Towers, 128 Yeoui-daero, Yeongdeungpo-gu, Seoul, 07336, Korea
----------	--	--

2	Model identifier	LP65WGC20P-EK, ADT-65DSU-D03-2			
3	Input voltage (V)	100-240			
4	Input AC frequency (Hz)	50-60			
5	Output voltage (V)	5.0	9.0	15.0	20.0
6	Output current (A)	3.0	3.0	3.0	3.25
7	Output power (W)	15.0	27.0	45.0	65.0
8	Average active efficiency (%)	81.39	86.62	87.73	88.00
9	Efficiency at low load (10 %) (%)	81.30	83.78	83.29	82.20
10	No-load power consumption (W)	0.1	0.1	0.1	0.21

*English: An adapter may not be available depending on the model.

*Català: Pot ser que no hi hagi cap adaptador disponible segons el model.

*French: Il se peut qu'aucun adaptateur ne soit disponible selon le modèle.

*German: Ein Adapter steht je nach Modell möglicherweise nicht zur Verfügung.

*Italian: Un adattatore potrebbe non essere disponibile in base al modello.

*Spanish: El adaptador puede no estar disponible en algunos modelos.

1 English: **Manufacturer's name or trade mark, commercial registration number and address**

Català: Nom del fabricant o marca, número de registre mercantil i adreça

Danish: Producentens navn eller varemærke, andelsregisternummer og adresse

Dutch: Naam of handelsmerk van de fabrikant, handelsregisternummer en adres

Finnish: Valmistajan nimi tai tavaramerkki, kaupparekisterinnumero ja osoite

French: Raison sociale ou marque déposée, numéro d'enregistrement au registre du commerce et adresse du fabricant

German: Name oder Handelsmarke des Herstellers, Handelsregisternummer und Anschrift

Hungarian: A gyártó neve vagy védjegye, cégjegyzékszám és címe

Italian: Nome o marchio del fabbricante, numero di iscrizione nel registro delle imprese e indirizzo del fabbricante

Polish: Nazwa lub znak towarowy producenta, numer rejestru handlowego i adres

Portuguese: Marca comercial ou nome, número de registo comercial e endereço do fabricante

Romanian: Denumirea producătorului sau marca comercială, numărul de înregistrare la Registrul Comerțului și adresa

Spanish: Nombre o marca, número del registro mercantil y dirección del fabricante

Swedish: Tillverkarens namn eller varumärke, organisationsnummer och adress

2 **English: Model identifier**

Català: Identificador del model

Danish: Modellens identifikationskode

Dutch: Typeaanduiding

Finnish: Mallitunniste

French: Référence du modèle

German: Modellkennung

Hungarian: Modellazonosító

Italian: Identificativo del modello

Polish: Identyfikator modelu

Portuguese: Identificador do modelo

Romanian: Identificator de model

Spanish: Identificador del modelo

Swedish: Modellbeteckning

Norwegian: Modellidentifikator

3 **English: Input voltage**

Català: Tensió d'entrada

Danish: Indgangsspænding

Dutch: Voedingsspanning

Finnish: Ottojännite

French: Tension d'entrée

German: Eingangsspannung

Hungarian: Bemenő feszültség

Italian: Tensione di ingresso

Polish: Napięcie wejściowe

Portuguese: Tensão de entrada

Romanian: Tensiune de intrare

Spanish: Tensión de entrada

Swedish: Ingående spänning

Norwegian: Inngangsspenning

4 **English: Input AC frequency**

Català: Freqüència d'entrada de CA

Danish: Inputvekselstrømsfrekvens

Dutch: Voedingsfrequentie

Finnish: Tuloverkkotaajuus

French: Fréquence du CA d'entrée

German: Eingangswechselstromfrequenz

Hungarian: Bemenő váltóáram frekvenciája
Italian: Frequenza di ingresso CA
Polish: Wejściowa częstotliwość prądu przemiennego
Portuguese: Frequência da alimentação de CA
Romanian: Frecvența c.a. de intrare
Spanish: Frecuencia de la CA de entrada
Swedish: Ingående frekvens (växelström)
Norwegian: Vekselstrømfrekvens inngang

5 English: **Output voltage**
Català: Tensió de sortida
Danish: Udgangsspænding
Dutch: Uitgangsspanning
Finnish: Antojännite
French: Tension de sortie
German: Ausgangsspannung
Hungarian: Kimenő feszültség
Italian: Tensione di uscita
Polish: Napięcie wyjściowe
Portuguese: Tensão de saída
Romanian: Tensiune de ieșire
Spanish: Tensión de salida
Swedish: Utgående spänning
Norwegian: Utgangsspenning

6 English: **Output current**
Català: Corrent de sortida
Danish: Udgangsstrømsstyrke
Dutch: Uitgangsstroom
Finnish: Antovirta
French: Courant de sortie
German: Ausgangsstrom
Hungarian: Kimenő áramerősség
Italian: Corrente di uscita
Polish: Prąd wyjściowy
Portuguese: Corrente de saída
Romanian: Curent de ieșire
Spanish: Intensidad de salida
Swedish: Utgående ström
Norwegian: Utgangsstrøm

-
- 7 English: **Output power**
Català: Potència de sortida
Danish: Udgangseffekt
Dutch: Uitgangsvermogen
Finnish: Antoteho
French: Puissance de sortie
German: Ausgangsleistung
Hungarian: Kimenő teljesítmény
Italian: Potenza di uscita
Polish: Moc wyjściowa
Portuguese: Potência de saída
Romanian: Putere de ieșire
Spanish: Potencia de salida
Swedish: Utgående effekt
Norwegian: Utgangseffekt
-

- 8 English: **Average active efficiency**
Català: Eficiència mitjana en actiu
Danish: Gennemsnitlig effektivitet i aktiv tilstand
Dutch: Gemiddelde actieve efficiëntie
Finnish: Aktiivitalan keskimääräinen hyötysuhde
French: Rendement moyen en mode actif
German: Durchschnittliche Effizienz im Betrieb
Hungarian: Aktív üzemmódban mért átlagos hatásfok
Italian: Rendimento medio in modo attivo
Polish: Średnia sprawność podczas pracy
Portuguese: Eficiência média no modo ativo
Romanian: Randament mediu în mod activ
Spanish: Eficiencia media en activo
Swedish: Genomsnittlig verkningsgrad i aktivt läge
Norwegian: Gjennomsnittlig aktiv effektivitet
-

- 9 English: **Efficiency at low load (10 %)**
Català: Eficiència a baixa càrrega (10 %)
Danish: Effektivitet ved lav belastning (10 %)
Dutch: Efficiëntie bij lage belasting (10 %)
Finnish: Hyötysuhde alhaisella kuormituksella (10 %)
French: Rendement à faible charge (10 %)
German: Effizienz bei geringer Last (10 %)
Hungarian: Hatásfok alacsony (10 %-os) terhelésnél

Italian: Rendimento a basso carico (10 %)

Polish: Sprawność przy niskim obciążeniu (10 %)

Portuguese: Eficiência a carga baixa (10%)

Romanian: Randamentul la sarcină redusă (10 %)

Spanish: Eficiencia a baja carga (10 %).

Swedish: Verkningsgrad vid låg last (10 %)

Norwegian: Effektivitet ved lav belastning (10 %)

10 English: **No-load power consumption**

Català: Consum d'energia en buit

Danish: Effektforbrug i nullast-tilstand

Dutch: Energieverbruik in niet-belaste toestand

Finnish: Kuormittamattoman tilan tehonkulutus

French: Consommation électrique hors charge

German: Leistungsaufnahme bei Nulllast

Hungarian: Üresjárású üzemmódban mért energiafogyasztás

Italian: Potenza assorbita nella condizione a vuoto

Polish: Zużycie energii w stanie bez obciążenia

Portuguese: Consumo energético em vazio

Romanian: Puterea absorbită în regim fără sarcină

Spanish: Consumo eléctrico en vacío

Swedish: Elförbrukning vid noll-last

Norwegian: Strømforbruk uten belastning

USA

FCC Notice (For USA)

This equipment has been tested and found to comply with the limits for a Class B digital device, pursuant to Part 15 of the FCC Rules. These limits are designed to provide reasonable protection against harmful interference in a residential installation. This equipment generates, uses, and can radiate radio frequency energy and, if not installed and used in accordance with the instructions, may cause harmful interference to radio communications.

However, there is no guarantee that interference will not occur in a particular installation. If this equipment does cause harmful interference to radio or television reception, which can be determined by turning the equipment off and on, the user is encouraged to try to correct the interference by one or more of the following measures:

- Reorient or relocate the receiving antenna.
- Increase the separation between the equipment and the receiver.
- Connect the equipment to an outlet on a circuit different from that to which the receiver is connected.
- Consult the dealer or an experienced radio/TV technician for help.

This device complies with part 15 of the FCC Rules. Operation is subject to the following two conditions:

- (1) this device may not cause harmful interference and
- (2) this device must accept any interference received, including interference that may cause undesired operation.

Any changes or modifications in construction of this device which are not expressly approved by the party responsible for compliance could void the user's authority to operate the equipment.

FCC Radio Frequency Interference Requirements (for UNII devices)

High power radars are allocated as primary users of the 5.25 to 5.35 GHz and 5.65 to 5.85 GHz bands. These radar stations can cause interference with and/or damage this device. This device cannot be co-located with any other transmitter.

FCC/IC Radio Frequency Exposure

The available scientific evidence does not show that any health problems are associated with using low power wireless devices. There is no proof, however, that these low power wireless devices are absolutely safe. Low power Wireless devices emit low levels of radio frequency energy (RF) in the microwave range while being used. Whereas high levels of RF can produce health effects (by heating tissue), exposure to low level RF that does not produce heating effects causes no known adverse health effects. Many studies of low level RF exposures have not found any biological effects. Some studies have suggested that some biological effects might occur, but such findings have not been confirmed by additional research. This device have been tested and found to comply with FCC/IC radiation exposure limits set forth for an uncontrolled environment and meets the FCC radio frequency (RF) Exposure Guidelines in Supplement C to OET65 and RSS-102 of the IC radio frequency (RF) Exposure rules(<1.6W/kg).

Operation of transmitters in the 5.925-7.125 GHz band is prohibited for control of or communications with unmanned aircraft systems.

Supplier's Declaration of Conformity	
Trade Name	LG
Responsible Party	LG Electronics USA, Inc.
Address	111 Sylvan Avenue, North Building Englewood Cliffs, New Jersey 07632
Email	lg.environmental@lge.com

Australia/New Zealand Notice

Exposure to radio frequency energy

Radio wave exposure and Specific Absorption Rate (SAR) information

This product has been designed to comply with applicable safety requirements for exposure to radio waves. These requirements are based on scientific guidelines that include safety margins designed to assure the safety of all persons, regardless of age and health

- The equipment complies with the RF Exposure Requirement 1999/519/EC, Council Recommendation of 12 July 1999 on the limitation of exposure of the general public to electromagnetic fields from 0 Hz to 300 GHz.
- The SAR limit recommended by the International Commission on Non-Ionizing Radiation Protection (ICNIRP) is 2 W/kg averaged over 10g of tissue.
- The highest SAR value for this model on the body is less than 2W/kg (10g)



RF Radiation Exposure Statement

The use of the 5,150 - 5,350 MHz and 5,945 - 6,425 MHz band (if applicable) is restricted to indoor use only. This restriction exists in the countries Australia (AU) and New Zealand (NZ). (For Wi-Fi/Bluetooth built-in model or Wi-Fi built-in model)

Brazil Notice

Este equipamento não tem direito à proteção contra interferência prejudicial e não pode causar interferência em sistemas devidamente autorizados.

Para mais informações, consulte o site da Anatel: <https://www.gov.br/anatel/pt-br>

GREEN MARK (for Japan)



本製品は、日本工業規格（JIS C0950:2008）における「電気・電子機器の特定の化学物質の含有表示方法」（通称J-Moss）の規定する特定化学物質の含有率が基準値以下に管理された製品であるため、J-Moss グリーンマークを表示しています。

特定の化学物質（鉛、水銀、カドミウム、六価クロム、PBB、PBDE）の含有についての情報は下記Webサイトをご覧ください。

Webサイト： <http://www.lg.com/jp/eco/eco-product#jMoss>

EPEAT



“EPEAT registered where applicable/supported. EPEAT registration varies by country - see

www.epeat.net for registration status by country.”

UKRAINE only

Обмеження України на наявність небезпечних речовин

Устаткування відповідає вимогам технічного регламенту щодо обмеженого використання небезпечних речовин в електричному і електронному обладнанні.

Ukraine Restriction of Hazardous Substances

The equipment complies with requirements of the Technical Regulation, in terms of restrictions for the use of certain dangerous substances in electrical and electronic equipment.

PACKING INFORMATION (CUSTOMS UNION)



РУССКИЙ

- Символ «петля Мебиуса» указывает на возможность утилизации упаковки. Символ может быть дополнен обозначением материала упаковки в виде цифрового и/или буквенного обозначения.

ҚАЗАҚША

- Символ қаптаманы жою мүмкіндігін көрсетеді. Символ сандық код және/немесе әріп белгілері түріндегі қаптама материалының белгісімен толықтырылуы мүмкін.

SAFETY REGULATION NOTICE

Battery

ENGLISH

- Risk of fire or explosion if the battery is replaced by an incorrect type.
- Replacement of a battery with an incorrect type that can defeat a safeguard (for example, in the case of some lithium battery types).
- Disposal of a battery into fire or a hot oven, or mechanically crushing or cutting of a battery, that can result in an explosion.
- Leaving a battery in an extremely high temperature surrounding environment that can result in an explosion or the leakage of flammable liquid or gas.
- A battery subjected to extremely low air pressure that may result in an explosion or the leakage of flammable liquid or gas.
- Do not store or transport at pressures lower than 11.6 kPa (1.68 psi) and at above 15 000 m (49212.5 feet) altitude.

DANSK

- Risiko for brand eller eksplosion, hvis batteriet udskiftes med en forkert type.
- Udskiftning af et batteri med en forkert type, der kan omgå en sikring (f.eks. i tilfælde af nogle lithiumbatterityper).
- Bortskaffelse af et batteri ved ild eller en varm ovn, eller mekanisk knusning eller skæring i et batteri, dette kan resultere i en eksplosion.
- At efterlade et batteri i omgivelser med ekstrem høj temperatur, det kan resultere i en eksplosion eller lækage af brændbar væske eller gas.
- Et batteri udsat for ekstremt lavt lufttryk, det kan resultere i en eksplosion eller lækage af brændbar væske eller gas.
- Må ikke opbevares eller transporteres ved tryk lavere end 11,6 kPa og over 15.000 meters højde.

SUOMI

- Tulen ja räjähdysten mahdollisuus, jos akku vaihdetaan vääränlaiseen akkuun.
- Vääränlaisen akun asennus voi ohittaa turvamekanismit (esimerkiksi joissain litium-akuissa).
- Akun hävittäminen tuleen tai kuumaan uuniin, tai akun mekaaninen tuhoaminen tai leikkaaminen, voivat johtaa räjähdykseen.
- Akun jättäminen äärimmäisen korkean lämpötilan ympäristöön voi johtaa räjähdykseen tai helposti syttyvän nesteen tai kaasun vuotoon.
- Äärimmäisen matalalle ilmanpaineelle altistettu akku voi johtaa räjähdykseen tai helposti syttyvän nesteen tai kaasun vuotoon.
- Älä säilö tai siirrä alle 11,6 kPa ilmanpaineissa tai yli 15 000 m korkeudessa.

NORSK

- Det er fare for brann eller eksplosjon i tilfelle batteriet byttes ut med en feil type.
- Utskifting av et batteri med en feil type som kan beseire en sikring (for eksempel når det gjelder noen typer litiumbatterier).
- Avhending av et batteri i brann eller en varm ovn, eller mekanisk knusing eller kutting av et batteri, som kan føre til en eksplosjon.

- Å etterlate et batteri i omgivelser med ekstremt høy temperatur som kan resultere i en eksplosjon eller lekkasje av brennbar væske eller gass.
- Et batteri som er utsatt for ekstremt lavt lufttrykk kan resultere i en eksplosjon eller lekkasje av brennbar væske eller gass.
- Produktet må aldri oppbevares eller transporteres ved trykk lavere enn 11,6 kPa og over 15000 m høyde.

SVENSKA

- Risk för brand eller explosion om batteriet byts ut mot fel typ.
- Byte av ett batteri mot en felaktig typ som kan motverka ett skydd (till exempel för vissa litiumbatterityper).
- Kassering av ett batteri i eld eller en het ugn, eller att krossa eller klippa sönder ett batteri mekaniskt, kan leda till en explosion.
- Att lämna ett batteri i en omgivning med extremt hög temperatur som kan leda till en explosion, eller läckage av brandfarlig vätska eller gas.
- Ett batteri som utsätts för extremt lågt lufttryck kan leda till en explosion eller läckage av brandfarlig vätska eller gas.
- Förvara eller transportera inte vid tryck under 11,6 kPa och på över 15 000 m höjd.

ESPAÑOL

- Existe riesgo de explosión si se cambia la batería por una de un tipo incorrecto.
- Sustitución de la batería por un tipo de batería incorrecto que puede anular los mecanismos de seguridad (por ejemplo, en el caso de algunos tipo de batería de litio).
- Colocación de una batería en el fuego o un horno caliente, o aplastamiento o corte mecánicos de una batería, que pueden provocar una explosión.
- Colocación de una batería en un entorno con una temperatura extremadamente alta que puede provocar una explosión o la fuga de líquido o gas inflamable.
- Una batería sometida a una presión del aire extremadamente baja que puede provocar una explosión o la fuga de líquido o gas inflamable.
- No almacenar ni transportar a una presión inferior a 11,6 kPa ni a una altitud superior a 15 000 m.

CATALÀ

- En cas de substituir la bateria per un model inadequat, hi ha risc d'incendi o d'explosió.
- La substitució de la bateria per un model inadequat pot anul·lar la garantia (per exemple, en el cas d'alguns tipus de bateries de liti).
- Si llenceu una bateria al foc o a un forn calent, o si la tritureu o talleu de manera mecànica, podeu provocar una explosió.
- Si deixeu la bateria sotmesa a una temperatura extremadament alta, es pot produir una explosió o la fuga de líquid o gas inflamable.
- Deixar una bateria sotmesa a una pressió d'aire extremadament baixa, podria provocar una explosió o la fuga de líquid o gas inflamable.
- No l'emmagatzemeu ni transporteu a pressions inferiors a 11,6 kPa ni a altituds superiors a 15 000 m.

PORTUGUÊS

- Risco de incêndio ou explosão se a bateria for substituída por uma do tipo incorreto.
- A substituição da bateria por uma do tipo incorreto pode desativar um sistema de segurança (por exemplo, no caso de algumas baterias de lítio).
- A eliminação de uma bateria no fogo ou num forno quente ou o esmagamento ou corte mecânico de uma bateria pode resultar numa explosão.

- Deixar uma bateria num ambiente de temperatura extremamente alta pode resultar numa explosão ou na fuga de líquidos ou gases inflamáveis.
- Uma bateria sujeita a pressão de ar extremamente baixa poderá resultar numa explosão ou na fuga de líquidos ou gases inflamáveis.
- Não armazene nem transporte a pressões inferiores a 11,6 kPa e acima de 15.000 m de altitude.

POLSKI

- Ryzyko pożaru lub wybuchu w przypadku wymiany baterii na niewłaściwy typ.
- Wymiana baterii na niewłaściwy typ może spowodować omińnięcie zabezpieczeń (np. w przypadku niektórych typów baterii litowych).
- Wrzucenie baterii do ognia lub gorącego piekarnika lub mechaniczne zmiżdżenie albo przecięcie baterii może spowodować wybuch.
- Pozostawienie baterii w środowisku o bardzo wysokiej temperaturze może spowodować wybuch lub wyciek łatwopalnej cieczy lub gazu.
- Narażenie baterii na bardzo niskie ciśnienie powietrza może spowodować wybuch lub wyciek łatwopalnej cieczy lub gazu.
- Nie przechowywać ani transportować przy ciśnieniu niższym niż 11,6 kPa lub na wysokości powyżej 15.000 m.

ITALIANO

- Rischio di incendio o esplosione se la batteria viene sostituita con una di tipo non corretto.
- La sostituzione della batteria con una di tipo non corretto può compromettere la sicurezza (ad esempio nel caso di alcune batterie al litio).
- Lo smaltimento delle batterie nel fuoco o in un forno caldo, o lo schiacciamento meccanico o il taglio delle batterie può provocare un'esplosione.
- L'esposizione delle batterie ad ambienti circostanti con temperature estremamente alte può causare un'esplosione o la fuoriuscita di liquidi o gas infiammabili.
- L'esposizione delle batterie a pressioni dell'aria estremamente basse può causare un'esplosione o la fuoriuscita di liquidi o gas infiammabili.
- Non conservare o trasportare a pressioni inferiori a 11,6 kPa e ad altitudini superiori a 15.000 m.

DEUTSCH

- Wird die Batterie durch einen anderen, falschen Typ ersetzt, besteht Explosions- und Brandgefahr.
- Wird die Batterie durch eine anderen, falschen Typ ersetzt, kann möglicherweise die Sicherung deaktiviert werden (das ist zum Beispiel bei einigen Lithium-Batterien der Fall).
- Wird eine Batterie entsorgt, indem Sie in einen Ofen geworfen wird oder mechanisch zerstört oder zerschnitten wird, besteht Explosionsgefahr.
- Wird die Batterie in einer Umgebung unter extrem heißer Temperatur belassen, besteht Explosionsgefahr oder es kann entflammbare Flüssigkeit oder entflammbares Gas austreten.
- Wird die Batterie extrem niedrigem Luftdruck ausgesetzt, besteht Explosionsgefahr oder es kann entflammbare Flüssigkeit oder entflammbares Gas austreten.
- Nicht bei einem Druck tiefer als 11,6 kPa oder in über 15 000 m Höhe über dem Meeresspiegel lagern oder transportieren.

MAGYAR

- Tűz- vagy robbanásveszély, ha az akkumulátort nem megfelelő típusúra cserélik.
- Az akkumulátor cseréje nem megfelelő típusúra, amely védelmet jelenthet (például néhány lítium elemtípus esetében).

- Az elemek tűzben vagy forró sütőben való megsemmisítése, vagy az elemek mechanikus összetörése vagy elvágása robbanást okozhat.
- Ha akkumulátort rendkívül magas hőmérsékletű környezetben hagyja, az robbanást vagy gyúlékony folyadék vagy gáz szivárgását okozhatja.
- Ha az akkumulátor rendkívül alacsony légnyomásnak van kitéve, az robbanást vagy gyúlékony folyadék vagy gáz szivárgását okozhatja.
- Ne tárolja és ne szállítsa 11,6 kPa-nál alacsonyabb nyomáson és 15 000 m magasság felett.

NEDERLANDS

- Brand- of explosiegevaar als de batterij wordt vervangen door een onjuist type.
- Het vervangen van de batterij door een batterij van het foute type, kan een veiligheid uitschakelen (bijvoorbeeld bij enkele types van lithiumbatterijen).
- Een batterij in een vuur of een hete oven werpen of een batterij verpletteren of snijden, kan leiden tot een explosie.
- Een batterij achterlaten in een omgeving met een extreem hoge temperatuur, kan leiden tot een explosie of het lekken van brandbare vloeistof of gas.
- Een batterij blootstellen aan een extreem lage luchtdruk, kan leiden tot een explosie of het lekken van brandbare vloeistof of gas.
- Niet bewaren of vervoeren bij een druk lager dan 11,6 kPa en een hoogte van meer dan 15.000 m.

ROMÂNĂ

- Risc de explozie dacă bateria este înlocuită cu un tip incorect.
- Înlocuirea unei baterii cu un tip incorect care poate depăși o protecție (de exemplu, în cazul unor tipuri de baterii litiu).
- Eliminarea unei baterii în foc sau cuptor încins, prin zdrobire mecanică sau tăiere poate conduce la o explozie.
- Lăsarea unei baterii într-un mediu înconjurător cu o temperatură extrem de ridicată poate conduce la o explozie sau la scurgere de lichid sau gaz inflamabil.
- O baterie supusă unei presiuni a aerului extrem de scăzută poate rezulta în scurgere de lichid sau gaz inflamabil.
- Nu stocați și nu transportați la presiuni mai mici de 11,6 kPa și la mai mult de 15000 m altitudine.

FRANÇAIS

- Risque d'incendie ou d'explosion si la batterie est remplacée par une batterie d'un type incorrect.
- Le remplacement par une batterie d'un type incorrect peut annuler un dispositif de sécurité (par exemple, dans le cas de certaines batteries au lithium).
- Éliminer une batterie dans le feu ou un four chaud, l'écraser mécaniquement ou la couper peut provoquer une explosion.
- Laisser une batterie dans un environnement à très haute température peut provoquer une explosion ou une fuite de liquide ou de gaz inflammable.
- Laisser une batterie à une pression extrêmement basse peut provoquer une explosion ou une fuite de liquide ou de gaz inflammable.
- Ne pas stocker ni transporter à des pressions inférieures à 11,6 kPa et à une altitude supérieure à 15 000 m.

العربية

- خطر نشوب حريق أو حدوث انفجار إذا تم استبدال البطارية بنوع غير صحيح.
- قد يؤدي استبدال البطارية بنوع غير صحيح إلى إبطال الحماية (على سبيل المثال، في حالة بعض أنواع بطاريات الليثيوم).
- قد يؤدي التخلص من البطارية في النار أو في فرن ساخن، أو تكسيرها أو قطعها ميكانيكيًا، إلى حدوث انفجار.
- قد يؤدي ترك البطارية في بيئة محيطة بدرجة حرارة عالية للغاية إلى حدوث انفجار أو تسرب سائل أو غاز قابل للاشتعال.

- قد يؤدي تعرض البطارية لضغط هواء منخفض للغاية إلى حدوث انفجار أو تسرب سائل أو غاز قابل للاشتعال.
- لا تقوم بالتخزين أو النقل عند مستويات ضغط أقل من 11.6 كيلو باسكال وعلى ارتفاع يزيد عن 15000 متر.

Australia Notice

ENGLISH

- The appliance is not intended for use by young children or infirm persons without supervision
- Young Children should be supervised to ensure that do not play with appliance
- If the appliance is supplied from a cord extension set or an electrical portable outlet device.
- The cord extension set on electrical portable outlet device must be positioned so that it is not subject to splashing or ingress of moisture

WEEE



ENGLISH (UK, Ireland)

Disposal of your old appliance

1. This crossed-out wheeled bin symbol indicates that waste electrical and electronic products (WEEE) should be disposed of separately from the municipal waste stream.
2. Old electrical products can contain hazardous substances so correct disposal of your old appliance will help prevent potential negative consequences for the environment and human health. Your old appliance may contain reusable parts that could be used to repair other products, and other valuable materials that can be recycled to conserve limited resources.
3. You can take your appliance either to the shop where you purchased the product, or contact your local government waste office for details of your nearest authorised WEEE collection point. For the most up to date information for your country please see www.lg.com/global/recycling

БЪЛГАРСКИ (Bulgaria)

Изхвърляне на стария уред

1. Символът със зачертаня контейнер показва, че отпадъците от електрическо и електронно оборудване (ОЕЕО) трябва да се изхвърлят отделно от битовите отпадъци.
2. Старите електрически продукти могат да съдържат опасни вещества и правилното изхвърляне на Вашия уред ще помогне за предотвратяване на негативните последици за околната среда и човешкото здраве. Вашият стар уред може да съдържа части за многократна употреба, които биха могли да бъдат използвани за ремонт на други продукти, както и други ценни материали, които могат да бъдат рециклирани с цел запазване на ограничените ресурси.
3. Можете да занесете Вашия уред или в магазина, от който сте го закупили или можете да се свържете с местния държавен офис за отпадъците, за да получите информация за най-близкия разрешен ОЕЕО пункт за събиране на отпадъци. За най-актуална информация от Вашата държава, моля, погледнете тук: www.lg.com/global/recycling

HRVATSKI (Croatia)

Zbrinjavanje starog uređaja

1. Ovaj simbol prekržižene kante za smeće na kotačićima označava kako se otpadni električni i električni proizvodi (WEEE) moraju zbrinjavati odvojeno od komunalnog otpada.
2. Dotrajali električni proizvodi mogu sadržavati opasne tvari stoga će ispravno zbrinjavanje vaših dotrajalih uređaja pomoći u sprječavanju potencijalnih negativnih posljedica na okoliš i ljudsko zdravlje. Vaš dotrajao uređaj može sadržavati dijelove koji se mogu ponovo iskoristiti za popravak drugih proizvoda te druge vrijedne materijale koji se mogu reciklirati i tako sačuvati ograničene resurse.
3. Ovisno o razini smetnje / štete i dobi stavke, stari proizvodi mogu se popraviti za više radnog života koji će spriječiti izbjegli otpada. Proizvodi koji nisu prikladni za ponovnu uporabu može se reciklirati da se oporavim vrijedne resurse i pomoći da se smanji globalno potrošnju novih sirovina.
4. Uređaj možete odnijeti u trgovinu u kojoj ste kupili proizvod ili možete kontaktirati ured za zbrinjavanje otpada kod vaših mjesnih nadležnih tijela te od njih saznati više informacija o najbližem ovlaštenom WEEE sabirnom centru. Za najnovije informacije iz svoje države pogledajte internetske stranice www.lg.com/global/recycling

ČESKY (Czech)

Likvidace starého přístroje

1. Tento symbol přeškrtnutého koše značí, že odpad z elektrických a elektronických výrobků (WEEE) je nutné likvidovat odděleně od linky komunálního odpadu.
2. Staré elektrické výrobky mohou obsahovat nebezpečné látky, takže správná likvidace starých přístrojů pomůže zabránit potenciálním negativním důsledkům pro životní prostředí a lidské zdraví. Staré přístroje mohou obsahovat znovu použitelné díly, které lze použít k opravě dalších výrobků a další cenné materiály, které lze recyklovat a šetřit tak omezené zdroje.
3. Spotřebiči můžete zanést buď do obchodu, kde jste ho zakoupili nebo se obrátit na místní správu komunálních odpadů, kde získáte podrobné informace o autorizovaném sběrném místě WEEE. Pro poslední aktuální informace z vaší země si prosím prostudujte web www.lg.com/global/recycling

DANSK (Denmark)

Bortskaffelse af dit gamle apparat

1. Dette symbol med en affaldsspand med kryds over angiver at elektrisk og elektronisk affald (WEEE) skal bortskaffes og genbruges korrekt, adskilt fra kommunens husholdningsaffald.
2. Gamle elektriske produkter kan indeholde farlige stoffer, så når du bortskaffer dit gamle apparat på korrekt vis, hjælper du med at forhindre mulige negative konsekvenser for miljø og mennesker. Dit gamle apparat kan indeholde dele som kan genbruges, fx til at reparere andre produkter, eller værdifulde materialer som kan genbruges og derved begrænse spild af værdifulde ressourcer.
3. Du kan enten tage apparatet til den butik hvor du købte det, eller kontakte dit lokale affaldskontor angående oplysninger om det nærmeste, autoriserede WEEE-samlepunkt. Find de sidste nye oplysninger for dit land på www.lg.com/global/recycling

SUOMI (Finland)

Vanhan laitteesi hävittäminen

1. Tämä yllirastitettu jäteastian merkki ilmaisee, että sähkö- ja elektronikkalaitteiden jätteet (WEEE) tulee pitää erillään kotitalousjätteestä ja viedä kunnalliseen kierrätyskeskukseen.
2. Vanhat sähkötuotteet voivat pitää sisällään vaarallisia aineita, joten loppuun käytetyn laitteen oikea hävittäminen ehkäisee ympäristö- ja terveyshaittoja. Vanha laitteesi saattaa pitää sisällään uudelleen käytettäviä osia, joita voidaan käyttää korjaamaan muita tuotteita, sekä arvokkaita materiaaleja, joita voidaan kierrättää rajoitettujen resurssien säästämiseksi.
3. Voit viedä laitteesi joko liikkeeseen, josta hankit tuotteen, tai ottaa yhteyttä paikallishallintosi ympäristötoimistoon koskien lähintä valtuutettua WEEE -keräyspistettä. Kaikkein viimeisimmät tiedot koskien maatasi, ks. osoitteessa www.lg.com/global/recycling

FRANÇAIS (France)

Recyclage de votre ancien appareil

1. Ce symbole de poubelle barrée d'une croix indique que votre équipement électrique et électronique (EEE) ne doit pas être jeté avec les ordures ménagères. Il doit faire l'objet d'un tri et d'une collecte sélective séparée.
2. Les équipements électriques que vous jetez peuvent contenir des substances dangereuses. Il est donc important de les jeter de façon appropriée afin d'éviter des impacts négatifs sur l'environnement et la santé humaine. L'équipement que vous jetez peut également contenir des pièces réutilisables pour la réparation d'autres produits ainsi que des matériaux précieux pouvant être recyclés pour préserver les ressources de la planète.
3. Vous pouvez rapporter votre appareil au commerçant qui vous l'a vendu ou contacter votre collectivité locale pour connaître les points de collecte de votre EEE. Vous trouverez également des informations à jour concernant votre pays en allant sur www.quefairedemesdechets.fr

NEDERLANDS (Netherlands)

Verwijdering van uw oude apparaat

1. Dit symbool van de doorgekruiste vuilnisbak geeft aan dat afgedankte elektrische en elektronische producten (WEEE) afzonderlijk van het huishoudelijke afval moeten worden verwijderd.
2. Oude elektrische producten kunnen gevaarlijke stoffen bevatten, dus een juiste verwijdering van uw oude apparaat helpt bij het voorkomen van mogelijke negatieve gevolgen voor het milieu en de volksgezondheid. Uw oude apparaat kan herbruikbare onderdelen bevatten die kunnen worden gebruikt voor het repareren van andere producten, en andere waardevolle materialen die kunnen worden gerecycled voor het behoud van beperkte grondstoffen.
3. U kunt uw apparaat meenemen naar de winkel waar u het product heeft gekocht, of u kunt contact opnemen met uw plaatselijke afvalverwerking instantie voor de gegevens van uw dichtstbijzijnde geautoriseerde WEEE-verzamelpunt. Voor de meest recente informatie voor uw land verwijzen wij u naar www.lg.com/global/recycling

DEUTSCH (Germany)

Entsorgung Ihrer Altgeräte

1. Das durchgestrichene Symbol eines fahrbaren Abfallbehälters weist darauf hin, dass Elektro- und Elektronik-Produkte (WEEE) getrennt vom Hausmüll entsorgt werden müssen. Bitte entsorgen Sie Altgeräte getrennt von anderem Abfall und bringen Sie diese zu einer ausgewiesenen Sammelstelle für das Recycling von elektrischen und elektronischen Geräten. Falls die Geräte Batterien oder Lampen enthalten, die vom Endverbraucher ohne Beschädigung leicht entnommen werden können, trennen Sie diese bitte vor der Entsorgung von den Hauptgeräten, es sei denn, Sie möchten, dass die alten Geräte wiederverwendet werden (alte Batterien und Lampen werden getrennt gesammelt). Bitte beachten Sie auch, dass Sie persönlich dafür verantwortlich sind, personenbezogene Daten auf dem Gerät zu löschen, bevor Sie Ihre Geräte entsorgen.
2. Alte elektrische Produkte können gefährliche Substanzen enthalten, die eine korrekte Entsorgung dieser Altgeräte erforderlich machen, um schädliche Auswirkungen auf die Umwelt und die menschliche Gesundheit zu vermeiden. Ihre ausgedienten Geräte können wiederverwendbare Teile enthalten, mit denen möglicherweise andere Produkte repariert werden können, aber auch sonstige wertvolle Materialien enthalten, die zur Schonung knapper Ressourcen recycelt werden können.
3. Sie können Ihr Gerät entweder in den Laden zurückbringen, in dem Sie das Produkt ursprünglich erworben haben oder Sie kontaktieren Ihre Gemeindeabfallstelle für Informationen über die nächstgelegene autorisierte WEEE Sammelstelle. Bitte beachten Sie, dass einige* Vertreiber verpflichtet sind :
 - bei der Abgabe eines neuen Elektro- oder Elektronikgerätes an einen Endnutzer ein Altgerät des Endnutzers der gleichen Geräteart unentgeltlich zurückzunehmen, und
 - Altgeräte, die in keiner äußeren Abmessung größer als 25 Zentimeter sind, im Einzelhandelsgeschäft oder in unmittelbarer Nähe hierzu unentgeltlich zurückzunehmen;

Wenn Offline oder Online Händler Neugeräte an Privathaushalte liefern, sind sie verpflichtet, Altgeräte direkt bei diesen abzuholen oder Rückgabemöglichkeiten in zumutbarer Entfernung anzubieten. Daher empfehlen wir Ihnen sich für weitere Informationen an Ihren Händler zu wenden.
4. LG Electronic Deutschland GmbH ist ordnungsgemäß als Hersteller in Deutschland registriert. Damit trägt LG deutschlandweit zur Sammlung von Elektro- und Elektronik-Altgeräten bei, die Sie in kommunalen Getrenntsammlstellen abgeben. Die aktuellsten Informationen finden Sie unter:

www.lg.com/global/recycling oder <https://www.lg.com/de/support/altgeraete-rueckgabe>.

* Vertreiber mit einer Verkaufsfläche für Elektro- und Elektronikgeräte von mindestens 400 Quadratmetern sowie Vertreiber von Lebensmitteln mit einer Gesamtverkaufsfläche von mindestens 800 Quadratmetern, die Elektro- und Elektronikgeräte anbieten

ΕΛΛΗΝΙΚΑ (Greece)

Απόρριψη της παλιάς σας συσκευής

1. Αυτό το διαγραμμένο σύμβολο του τροχοφόρου κάδου υποδεικνύει ότι τα απόβλητα ηλεκτρικών και ηλεκτρονικών προϊόντων (ΑΗΗΕ) πρέπει να απορρίπτονται χωριστά από τα γενικά οικιακά απορρίμματα.
2. Τα παλιά ηλεκτρικά προϊόντα μπορεί να περιέχουν επικίνδυνες ουσίες και ως εκ τούτου η σωστή απόρριψη της παλιάς σας συσκευής αποτρέπει ενδεχόμενες αρνητικές συνέπειες για το περιβάλλον και την ανθρώπινη υγεία. Η παλιά σας συσκευή μπορεί να περιέχει επαναχρησιμοποιήσιμα ανταλλακτικά που θα μπορούσαν να χρησιμοποιηθούν για την επισκευή άλλων προϊόντων, καθώς και άλλα υλικά αξίας που μπορούν να ανακυκλωθούν για εξοικονόμηση των περιορισμένων φυσικών πόρων.
3. Μπορείτε να πάτε τη συσκευή σας, είτε στο κατάστημα από το οποίο αγοράσατε το προϊόν, ή να επικοινωνήσετε το τοπικό γραφείο απορριμμάτων για λεπτομέρειες σχετικά με το πλησιέστερο εγκεκριμένο σημείο συλλογής ΑΗΗΕ (Απόβλητα Ηλεκτρικών και Ηλεκτρονικών Συσκευών). Για τις πιο πρόσφατες πληροφορίες για τη χώρα σας επισκεφθείτε τη διεύθυνση www.lg.com/global/recycling

MAGYAR (Hungary)

A régi készülék ártalmatlanítása

1. A leselejtezett elektromos és elektronikai termékeket a háztartási hulladéktól elkülönítve kell begyűjteni, a jogszabályok által kijelölt módon és helyen.
2. Régi készülékeinek megfelelő leselejtezése segíthet megelőzni az esetleges egészségre vagy környezetre ártalmas hatásokat.
3. Ha további információra van szüksége régi készülékeinek leselejtezésével kapcsolatban, lépjen kapcsolatba velünk a szelektalok.hu oldalon ahol tájékoztatjuk Önt visszavételi, átvételi, gyűjtési és kezelési kötelezettségeinkről.

ITALIANO (Italy)

Smaltimento delle apparecchiature obsolete

1. Tutte le apparecchiature elettriche ed elettroniche, contrassegnate da questo simbolo ("bidone della spazzatura barrato da una croce"), devono essere raccolte e smaltite separatamente rispetto agli altri rifiuti urbani misti mediante impianti di raccolta specifici installati da enti pubblici o dalle autorità locali. Si ricorda che gli utenti finali domestici possono consegnare gratuitamente le apparecchiature elettriche ed elettroniche a fine vita presso il punto vendita all'atto dell'acquisto di una nuova apparecchiatura equivalente. Gli utenti finali domestici possono inoltre consegnare gratuitamente apparecchiature elettriche ed elettroniche di piccolissime dimensioni (non eccedenti i 25 cm) a fine vita direttamente presso un punto vendita a ciò abilitato, senza obbligo di acquistare una apparecchiatura nuova di tipo equivalente. Si prega di informarsi previamente presso il punto vendita prescelto circa tale ultima modalità di conferimento dell'apparecchiatura a fine vita.
2. Il corretto smaltimento dell'unità obsoleta contribuisce a prevenire possibili conseguenze negative sulla salute degli individui e sull'ambiente. Una gestione responsabile del fine vita delle apparecchiature elettriche ed elettroniche da parte degli utenti contribuisce al riutilizzo, al riciclaggio ed al recupero sostenibile dei prodotti obsoleti e dei relativi materiali.
3. Per informazioni più dettagliate sullo smaltimento delle apparecchiature obsolete, contattare l'ufficio del comune di residenza, il servizio di smaltimento rifiuti o il punto vendita in cui è stato acquistato il prodotto. (www.lg.com/global/recycling)

NORSK (Norway)

Avhending av gamle apparater

1. Dette symbolet av en utkrysset avfallsdunk indikerer at kassert elektronikk og elektroniske produkter (WEEE) skal kastes separat fra husholdningsavfall og leveres til den kommunale resirkuleringen.
2. Gamle elektriske produkter kan inneholde farlige stoffer, så korrekt avfallshåndtering av det gamle apparatet bidrar til å hindre potensielt negative konsekvenser for miljøet og andres helse. Gamle apparater kan inneholde gjenbrukbare deler som kan brukes til å reparere andre produkter og andre verdifulle materialer som kan resirkuleres for å bevare begrensede ressurser.
3. Du kan bringe apparatet enten til butikken der du kjøpte produktet, eller ta kontakt med den lokale myndighetens avfallskontor for informasjon om nærmeste autoriserte innsamlingspunkt for el-avfall (WEEE-avfall). For den mest oppdaterte informasjonen for ditt land, gå til www.lg.com/global/recycling.

POLSKI (Poland)

Utylizacja starego urządzenia

1. Symbol przekreślonego pojemnika na odpady na kótkach oznacza, że produkty elektryczne lub elektroniczne (WEEE) należy zutylizować poza obiegiem odpadów komunalnych.
2. Stare produkty elektroniczne mogą zawierać niebezpieczne substancje. Właściwa utylizacja starego urządzenia pozwoli uniknąć potencjalnych negatywnych skutków dla środowiska i zdrowia. Stare urządzenie może zawierać części wielokrotnego użytku, które mogą zostać wykorzystane do naprawy innych produktów lub inne wartościowe materiały, które można przetworzyć, aby oszczędzać zasoby naturalne.
3. Urządzenie można oddać do sklepu, w którym zostało kupione lub skontaktować się z lokalnym urzędem gospodarki odpadami, aby uzyskać informacje o najbliższym punkcie zbiórki WEEE. Aby uzyskać aktualne informacje z zakresu gospodarki odpadami obowiązującej w danym kraju, należy odwiedzić stronę <http://www.lg.com/global/sustainability/environment/take-back-recycling/global-network-europe> (plik PDF : "For more information about how to recycle LG products in your country").

PORTUGUÊS (Portugal)

Eliminação do seu aparelho usado

1. Este símbolo de um caixote do lixo com rodas e linhas cruzadas sobrepostas indica que os resíduos de produtos elétricos e eletrônicos (REEE) devem ser eliminados separadamente do lixo doméstico.
2. Os produtos elétricos usados podem conter substâncias perigosas, pelo que, a eliminação correta do seu aparelho usado pode contribuir para evitar potenciais consequências negativas para o ambiente e saúde humana. O seu aparelho usado pode conter peças reutilizáveis que podem ser usadas para reparar outros produtos e outros materiais úteis que podem ser reciclados para preservar os recursos limitados.
3. Pode levar o seu aparelho à loja onde o adquiriu, ou contactar a sua entidade local de recolha e tratamento de resíduos para obter mais informações relativas ao ponto de recolha de REEE autorizado mais próximo. Para obter informações mais atualizadas relativas ao seu país, visite www.lg.com/global/recycling

ROMÂNĂ (Romania)

Eliminarea aparatului vechi

1. Simbolul de pubeleă indică faptul că deșeurile de echipamente electrice și electronice (DEEE) trebuie eliminate separat de celelalte deșeuri.
2. Produsele electrice și electronice vechi conțin substanțe periculoase. Astfel, prin eliminarea corespunzătoare veți contribui la prevenirea deteriorării mediului înconjurător și al sănătății umane. Este posibil ca dispozitivul dvs. vechi să conțină piese componente care pot fi folosite pentru repararea altor produse sau materiale importante ce pot fi reciclate în scopul economisirii resurselor limitate.
3. Dispozitivul vechi poate fi returnat magazinului de unde a fost achiziționat sau puteți contacta firma responsabilă pentru eliminarea deșeurilor în scopul aflării locației unității autorizate pentru reciclarea deșeurilor electrice și electronice (WEEE). Pentru informații mereu actualizate și referitoare la țara dvs. vă rugăm să vizitați pagina web www.lg.com/global/recycling.

SRPSKI (Serbia)

Odlaganje starog aparata

1. Ovaj simbol precrtana kanta za smeće pokazuje da električni i elektronski otpad (WEEE) treba da se odlaže odvojeno od običnog komunalnog otpada.
2. Stari električni aparati mogu da sadrže otrovne supstance, tako da će pravilno odlaganje Vašeg starog aparata pomoći sprečavanju pojave negativnih posledica po životnu sredinu i zdravlje ljudi. Vaš stari aparat može da sadrži delove za višekratnu upotrebu koji se mogu koristiti za zamenu drugih proizvoda i druge vredne materijale koji se mogu reciklirati radi očuvanja ograničenih resursa.
3. Vaš aparat možete da odnesete u radnju gde ste ga kupili ili da kontaktirate lokalnu vladinu kancelariju za otpad kako biste dobili informaciju o najbližoj autorizovanoj WEEE stanici za odlaganje ovog otpada. Za najnovije informacije za Vašu zemlju, molimo Vas da pogledate web stranicu www.lg.com/global/recycling.

SLOVENČINA (Slovakia)

Zneškodnenie starého spotrebiča

1. Tento symbol prečiarknutého odpadkového koša na kolieskach znamená, že odpad z elektrických a elektronických zariadení (WEEE) musí byť zneškodnený samostatne od komunálneho odpadu.
2. Staré elektrické produkty môžu obsahovať nebezpečné latky, preto správne zneškodnenie vášho starého spotrebiča pomôže zabrániť potenciálnym negatívnym dopadom na prostredie a ľudské zdravie. Váš starý spotrebič môže obsahovať diely, ktoré možno opätovne použiť na opravu iných produktov, a iné cenné materiály, ktoré možno recyklovať s cieľom chrániť obmedzené zdroje.
3. Svoj spotrebič môžete zaniest' do predajne, kde ste produkt zakúpili, alebo sa môžete obrátiť na oddelenie odpadov miestnej samosprávy a požiadať o informácie o najbližšom zbernom mieste odpadu z elektrických a elektronických zariadení (WEEE). Najnovšie informácie platné pre vašu krajinu nájdete na stránke www.lg.com/global/recycling

SLOVENŠČINA (Slovenia)

Odstranjevanje vaše stare naprave

1. Prečrtan simbol smetnjaka opozarja, da je treba odpadne električne in elektronske izdelke (OEEI) odstranjevati ločeno od ostalih komunalnih odpadkov.
2. Odpadni električni izdelki lahko vsebujejo nevarne snovi, zato s pravilnim odstranjevanjem stare naprave prispevate k preprečevanju morebitnih negativnih vplivov na okolje in zdravje ljudi. Vaša stara naprava lahko vsebuje dele, ki jih je mogoče uporabiti za popravilo drugih izdelkov, in druge dragocene materiale, ki jih je mogoče reciklirati in s tem ohraniti omejene vire.
3. Svojo napravo lahko odnesete v trgovino, kjer ste jo kupili, ali pa se glede podrobnosti o najbližjem pooblaščenem zbirnem mestu za odpadno električno in elektronsko opremo obrnite na lokalno komunalno podjetje. Za najnovejše informacije za svojo državo si oglejte www.lg.com/global/recycling.

ESPAÑOL (Spain)

Símbolo para marcar AEE

1. El símbolo del contenedor de basura tachado con un aspa indica que la recogida separada de aparatos eléctricos y electrónicos (AEE) debe realizarse de manera separada.
2. Los productos eléctricos antiguos pueden contener sustancias peligrosas de modo que la correcta eliminación del antiguo aparato ayudará a evitar posibles consecuencias negativas para el medio ambiente y para la salud humana. El antiguo aparato puede contener piezas reutilizables que podrían utilizarse para reparar otros productos y otros materiales valiosos que pueden reciclarse para conservar los recursos limitados.
3. Este producto contiene pilas y/o acumuladores. Siempre que no sea necesaria la intervención de un profesional cualificado para ello, y antes del depósito final del producto en las instalaciones de recogida selectiva, usted debe extraer las pilas y acumuladores de forma segura y separadamente para su adecuada gestión.
4. Puede llevar el aparato a cualquiera de los centros autorizados para su recogida. Para obtener la información más actualizada para su país por favor visite www.lg.com/global/recycling

CATALÀ (Spain)

Eliminació de l'aparell vell

1. Aquest símbol d'un contenidor amb rodes ratllat amb una creu indica que els residus de productes elèctrics i electrònics (RAEE) han d'eliminar-se per separat dels residus urbans.
2. Els productes elèctrics vells poden contenir substàncies perilloses, per la qual cosa elimineu de forma correcta el vostre aparell vell per evitar possibles efectes negatius en el medi ambient i en la salut de les persones. L'aparell vell pot contenir peces reutilitzables que es poden fer servir per reparar altres productes, a més d'altres materials valuosos que es poden reciclar per preservar els recursos limitats.
3. Podeu portar l'aparell a la botiga on el va comprar o contactar amb l'oficina de reciclatge de l'administració local perquè us indiquin el punt de recollida RAEE autoritzat més pròxim. Per obtenir la informació més actualitzada del vostre país, consulteu www.lg.com/global/recycling

SVENSKA (Sweden)

Bortskaffning av den gamla produkten

1. Den överkorsade soptunnesymbolen indikerar att elektroniskt och elektriskt avfall (WEEE) ska sorteras separat från hushållsavfallet och lämnas in till en av kommunen anvisad plats för återvinning.
2. Kasserade elektroniska och elektriska produkter kan innehålla farliga substanser, korrekt avfallshantering av produkten förhindrar negativa konsekvenser för miljön och den mänskliga hälsan. Din gamla produkt kan även innehålla återanvändningsbara delar som kan användas för att reparera andra produkter samt innehålla värdefulla ämnen som kan återvinnas för att spara jordens resurser.
3. Du kan ta din gamla produkt till butiken där du köpte den eller kontakta din kommun för information om närmaste WEEE-uppsamlingsställe. För att få den senaste informationen för ditt land, gå till www.lg.com/global/recycling

РУССКИЙ (Russia)

Утилизация старого оборудования

1. Этот перечеркнутый символ мусорной корзины указывает на то, что отработанные электрические и электронные изделия (WEEE) следует утилизировать отдельно от бытовых отходов.
2. Старые электрические изделия могут содержать опасные вещества, поэтому правильная утилизация старой техники поможет предотвратить возможные негативные последствия для окружающей среды и здоровья человека. Старая техника может содержать детали, которые могут быть повторно использованы для ремонта других изделий, а также другие ценные материалы, которые можно переработать, чтобы сохранить ограниченные ресурсы.
3. Вы можете отнести свое устройство в магазин, где оно было приобретено, либо связаться с органами местного самоуправления для получения подробных сведений о ближайшем пункте приема отходов электрического и электронного оборудования (WEEE). Для получения актуальной информации относительно вашей страны обращайтесь по адресу: www.lg.com/global/recycling

TÜRKÇE (Türkiye)

Eski cihazınızın atılması

1. Tüm elektrikli ve elektronik atıklar, devlet ya da yerel yetkililer tarafından belirlenen toplama merkezlerinde ayrı olarak imha edilmelidir. Atık elektrikli ve elektronik aletler belediyeler tarafından kurulan toplama noktalarına teslim edilmeli veya aldığınız yeni ürünü satıcınıza adresinize teslim ederken, satıcınızdan atık elektrikli ve elektronik aletinizi teslim almasını istemelisiniz.
2. Atık ürünün doğru imhası çevre ve insan sağlığı üzerindeki potansiyel olumsuz sonuçların engellenmesine yardımcı olacaktır.
3. Bu işareti içeren ürünler tehlikeli madde içerebilir. Ürünler içerisindeki tehlikeli maddeler çevre kirlenmesine veya yaralanma/ölüme sebebiyet verebilir.
4. AEEE Yönetmeliğine Uygundur.
5. Eski ürününüzün imhası hakkında daha fazla bilgi için lütfen belediyeniz ya da ürünü aldığınız mağaza ile iletişime geçiniz. (www.lg.com/global/recycling)

УКРАЇНСЬКА (Ukraine)

Утилізація старого обладнання

1. Цей перекреслений символ сміттевого кошика вказує, що відпрацьовані електричні та електронні вироби (WEEE) потрібно утилізувати окремо від побутових відходів.
2. Старі електричні вироби можуть містити небезпечні речовини, тому правильна утилізація старого обладнання допоможе запобігти можливим негативним наслідкам для навколишнього середовища та здоров'я людини. Старе обладнання може містити деталі, які можуть бути використані повторно для ремонту інших виробів, а також інші цінні матеріали, які можливо переробити, щоб зберегти обмежені ресурси.
3. Ви можете віднести свій прилад в магазин, де його було придбано, або зв'язатися з органами місцевого самоврядування, щоб отримати докладні відомості про найближчий пункт прийому відходів електричного та електронного обладнання (WEEE). Щоб отримати найсвіжішу інформацію щодо вашої країни, звертайтеся за адресою: www.lg.com/global/recycling

ҚАЗАҚША (Kazakhstan)

Ескі жабдықты жою және қайта өңдеу

1. Сызылған қоқыс белгісі, пайдаланылған электр өнімдерін (WEEE өнімдері) тұрмыстық қалдықтардан бөлек тастау керектігін көрсетеді.
2. Ескі электр бұйымдарында қауіпті заттар болуы мүмкін, сондықтан ескі жабдықты дұрыс тастау қоршаған ортаға және адам денсаулығына жағымсыз салдардың алдын алуға көмектеседі. Сіздің ескі құрылғыңызда басқа өнімдерді жөндеуге қолданылатын қайта пайдалануға болатын бөлшектер, сондай-ақ шектеулі ресурстарды үнемдеу үшін қайта өңдеуге болатын басқа құнды материалдар болуы мүмкін.
3. Сіз өзіңіздің құрылғыңызды өнімді сатып алған дүкенге апара аласыз немесе WEEE-дің ең жақын уәкілетті жинау орны туралы білу үшін жергілікті муниципалды қалдықтарды басқару кеңсесіне жүгіне аласыз. Сіздің еліңіз үшін ең соңғы ақпаратты www.lg.com/global/recycling сайтына қарауға болады.

EESTI (Estonian)

Vana seadme hävitamine

1. Läbikriipsutatud ristiga prügikasti sümbol tähendab, et elektri- ja elektroonikaseadmete (WEEE) jäätmed tuleb kõrvaldada olmeprügist eraldi.
2. Vanad elektriseadmed võivad sisaldada ohtlikke koostisosi, seega aitab prügi nõuetekohane hävitamine vältida võimalikku negatiivset mõju loodusele ja inimeste tervisele. Teie kasutatud seade võib sisaldada taaskasutatavaid osi, millega saab parandada teisi seadmeid ning muid väärtuslikke materjale, mida saab taaskasutada, et säilitada piiratud ressursse.
3. Saate viia oma seadme kas kauplusse, kust see on ostetud või võtta ühendust kohaliku prügiveo ettevõttega, et saada lisainfot oma lähima WEEE jäätmete kogumiskoha kohta. Kõige ajakohasemat infot oma riigi kohta vaadake www.lg.com/global/recycling

LATVIEŠU (Latvian)

Jūsu vecās ierīces likvidēšana

1. Šis simbols – pārsvītrotā atkritumu tvertne uz riteņiem – norāda, ka elektrisko un elektronisko iekārtu atkritumi (EEIA) jāutilizē atsevišķi no sadzīves atkritumu plūsmas.
2. Veci elektriskie izstrādājumi var saturēt bīstamas vielas, tādēļ jūsu vecās ierīces pareiza utilizācija palīdzēs novērst iespējamās negatīvās sekas videi un cilvēka veselībai. Jūsu vecā ierīce var saturēt vairākkārt izmantojamas detaļas, kuras var izmantot citu izstrādājumu remontam, un citus vērtīgus materiālus, kurus var pārstrādāt, tādējādi saglabājot ierobežotus resursus.
3. Jūs varat aiznest ierīci vai nu uz veikalu, kurā šo izstrādājumu iegādājieties, vai sazināties ar vietējās pašvaldības atkritumu savākšanas iestādi un uzzināt sīkāku informāciju par tuvāko oficiālo EEIA savākšanas punktu. Jaunāko informāciju par savu valsti skatiet vietnē www.lg.com/global/recycling.

LIETUVIŲ K. (Lithuanian)

Seno prietaiso utilizavimas

1. Išbrauktos šiukšlių dėžės simbolis rodo, kad elektros ir elektronikos įrangos atliekas (EEĶA) reiktų utilizuoti atskirai nuo buitinių atliekų.
2. Senoje elektrinėje įrangoje gali būti pavojingų medžiagų, taigi tinkamas seno prietaiso utilizavimas padės apsaugoti nuo galimų neigiamų pasekmių aplinkai ir žmonių sveikatai. Jūsų sename prietaise gali būti dalių, kurias galima panaudoti dar kartą taisant kitą įrangą, ir kitų vertingų medžiagų, kurias galima perdirbti siekiant tausoti ribotus išteklius.
3. Savo prietaisą galite nugabenti į parduotuvę, kurioje jį įsigijote, arba kreipkitės į vietos valdžios atliekų tarnybą ir sužinokite, kur yra artimiausia EEĶA surinkimo vieta. Norėdami gauti daugiau informacijos apie savo šalies reikalavimus, apsilankykite www.lg.com/global/recycling.



LG Take-back & Recycling Policy (For USA)

LG Electronics offers a customized e-waste take-back & recycling service that meets local needs and requirements in the countries where e-waste regulations are in place, and also provides product take-back & recycling service voluntarily in some regions. LG Electronics evaluates products' recyclability at the design step selectively, with the goal of improving recyclability where practicable. Through these activities, LG Electronics seeks to contribute to conserving natural resources and protecting the environment. For more information, please visit our global site at <https://www.lg.com/global/recycling>

Battery take-back information (For USA)

In case rechargeable battery is included in this product, the entire device should be recycled in compliance with rechargeable battery recycling standards because of the internal battery. To dispose of properly, call (800) 822-8837 or visit www.call2recycle.org.

INDIA ONLY

Environmental information



Disposal of your old appliance (as per e-waste Rules)

1. When this crossed out wheeled bin symbol is depicted on the product and its operator's manual, it means the product is covered by E-Waste Management Rules India published by MoEF & CC, Govt. of India and are meant to be recycled, dismantled, refurbished or disposed off.

2. Do's :

- The product is required to be handed over only to the authorized recycler for disposal.
- Keep the product in isolated area, after it becomes non-functional/unrepairable so as to prevent its accidental breakage.

Don'ts :

- The product should not be opened by the user himself/herself, but only by authorized service personnel.
- The product is not meant for re-sale to any unauthorized agencies/scrap dealer/kabariwalah.
- The product is not meant for mixing into household waste stream.
- Do not keep any replaced spare part(s) from the product in exposed area.

- Any disposal through unauthorized agencies/person will attract action under Environment (Protection) Act 1986.
- This product is complied with the requirement of Hazardous Substances as specified under E-Waste Management Rules India published by MoEF & CC, Govt. of India.
- To locate a nearest collection centre or call for pick-up (limited area only) for disposal of this appliance, please contact No. 08069379999, Toll Free No. 1800-315-9999 for details. All collection centre and pick up facilities are done by third parties with LG Electronics India Ltd. Merely as a facilitator. For more detailed information, please visit : <http://www.lg.com/in>.

Battery



- This symbol may be combined with chemical symbols for mercury(Hg), cadmium(Cd) or lead(Pb) if the battery Contains more that 0.0005% of mercury, 0.002% of cadmium or 0.004% of lead.
- All batteries/accumulators should be disposed separately from the municipal waste stream via designated collection facilities appointed by the government or the local authorities.
- The correct disposal of Your old batteries/accumulators will help to prevent potential negative consequences for the environment, animal and human health.

पर्यावरणीय जानकारी



अपने पुराने निपटान के उपकरण (ई-अपशिष्ट नियम के अनुसार)

1. जब इस काटे गए पहिये वाले बिन का चिन्ह किसी उपकरण और इसके ओपरेटर की पुस्तिका के साथ संलग्न होता है तो इसका मतलब है कि इसे "ई- अपशिष्ट "(प्रबंधन और हथालन) नियम के अंतर्गत सम्मिलित किया गया है , और इसे नवीनीकरणकरण ,विघटन और निपटान के लिए बनाया गया है ।

MoEF & CC भारत सरकार द्वारा प्रकाशित (भारतीय ई- अपशिष्ट "(प्रबंधन और हथालन))

2. करें

क . उपकरण को सिर्फ अधिकृत पुनः नवीनीकरणकर्ता को ही निपटारण करने हेतु हस्तांतरित करें ।

ख. जब उपकरण कार्यरत न हो इसे अलग क्षेत्र में रखें ताकि उपकरण से होने वाली दुर्घटनाओं से बचा जा सके ।

न करें

क. इस उपकरण को स्वयं/खुद नहीं खोलना चाहिए ! उपकरण को केवल अधिकृत अधिकारी के द्वारा ही खोला जाना चाहिए ।

ख. इस उपकरण को पुनः बिक्री के लिए किसी भी कबाड़ीवाला / भंगार-वाला / अनाधिकृत संस्था को न दें ।

ग. इस उपकरण को किसी घरेलू अपशिष्ट सामान के साथ मिलाकर न रखें ।

घ. उपकरण के बदले हुए या आंतरिक पुरजो को खुले क्षेत्र में न रखें ।

3. यदि किसी अनाधिकृत विभाग या व्यक्ति के द्वारा निपटारण किया जाता है तो यह पर्यावरण (सुरक्षा) धारा १९८६ के अंतर्गत आता है ।

4. यह उत्पाद ई-अपशिष्ट (प्रबंधन और हथालन) नियम के तहत निर्दिष्ट खतरनाक पदार्थों की आवश्यकता का पालन करता है ।

MoEF & CC भारत सरकार द्वारा प्रकाशित (भारतीय ई- अपशिष्ट "(प्रबंधन और हथालन))

5. उपरोक्त पदार्थों के निपटारण के लिए नजदीकी निपटारण संस्थान (संकीर्ण क्षेत्र)में कॉल करें। अधिक जानकारी के लिए हमारे 08069379999 / टोल फ्री नंबर 1800-315-9999 पर कॉल करें. सभी संग्रहण केंद्र व पिक-अप की सुविधाएं किसी थर्ड- पार्टी जो "LG Electronics India Ltd."को अपनी सेवाएं प्रदान कर रही हों, से करवाएं । ज्यादा जानकारी के लिए देखें वेब:साईट - <http://www.lg.com/in>

बैटरी

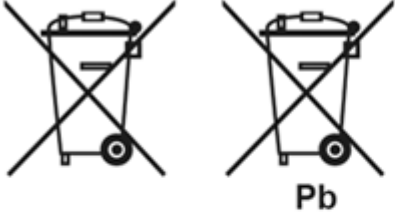

क. इस प्रतीक को पारा (Hg), कैडमियम (Cd) या सीसा (Pb) के लिए रासायनिक प्रतीकों के साथ जोड़ा जा सकता है यदि बैटरी में 0.0005% पारा, 0.002% कैडमियम या 0.004% सीसा हो।

ख. सभी बैटरियों/संचयकर्ताओं को सरकार या स्थानीय अधिकारियों द्वारा नियुक्त निर्दिष्ट संग्रह सुविधाओं के माध्यम से नगरपालिका अपशिष्ट धारा से अलग से निपटाया जाना चाहिए।

ग. आपकी पुरानी बैटरियों/संचायकों का सही निपटान पर्यावरण, पशु और मानव स्वास्थ्य के लिए संभावित नकारात्मक परिणामों को रोकने में मदद करेगा।

BRAZIL ONLY



Produto, Pilhas e Baterias:

1. Não é recomendável o descarte do produto, assim como pilhas, baterias, acessórios em lixo comum.
2. Após o uso, estes itens devem ser descartados de forma ambientalmente adequada, sob o risco de ocasionarem danos ao meio ambiente e à saúde humana (Resolução Conama 401/2008)
3. No fim de sua vida útil, descarte o produto de forma ambientalmente adequada, sob pena de ocasionar danos ao meio ambiente e à saúde humana.

Programa Coleta Inteligente

1. A LG criou o Programa Coleta Inteligente, para facilitar e viabilizar o descarte ambientalmente adequado de produtos, pilhas e baterias.
2. Através do Programa Coleta Inteligente, a LG disponibiliza pontos de coleta em localidades diversas, incluindo assistências técnicas autorizadas da LG Electronics. Para mais informações visite o site www.lg.com/br/suporte/coleta-seletiva ou contate nosso SAC através do número 4004-5400 (Capitais e Regiões metropolitanas) ou 0800-707- 5454 (demais localidades).

SAUDI ARABIA ONLY

1. All batteries should be disposed separately from the municipal waste stream via designated collection facilities appointed by the government or the local authorities.
2. The correct disposal of your old batteries will help to prevent potential negative consequences for the environment, animal and human health.

3. For more detail information about disposal of your old batteries, please contact your city office, waste disposal service or the shop where you purchased the product.

Also You can contact our LG Support Representative Call center from below Link https://www.lg.com/sa_en/support/contact/telephone

1 يجب التخلص من جميع البطاريات بشكل منفصل عن مجاري النفايات البلدية عن طريق مرافق الجمع المعينة التي تعينها الحكومة أو السلطات المحلية.

2 يساعد التخلص الصحيح من البطاريات القديمة في منع الآثار السلبية المحتملة على البيئة وصحة الحيوان والبشر.

3 لمزيد من المعلومات التفصيلية حول التخلص من البطاريات القديمة ، يرجى الاتصال بمكتب خدمة التخلص من النفايات في مدينتك أو المتجر الذي اشتريته منه المنتج. كما يمكنك الاتصال بمركز اتصال ممثل دعم LG عن طريق الدخول علي الرابط التالي

https://www.lg.com/sa_en/support/contact/telephone

BATTERY



ENGLISH

1. This symbol may be combined with chemical symbols for mercury(Hg), cadmium(Cd) or lead(Pb) if the battery Contains more that 0.0005% of mercury, 0.002% of cadmium or 0.004% of lead.
2. All batteries/accumulators should be disposed separately from the municipal waste stream via designated collection facilities appointed by the government or the local authorities.
3. The correct disposal of Your old batteries/accumulators will help to prevent potential negative consequences for the environment, animal and human health.
4. For more detailed information about disposal of Your old batteries/accumulators, please contact Your city office, waste disposal service or the shop where You purchased the product. (<http://www.lg.com/global/sustainability/environment/take-back-recycling/global-network-europe>)

FRANÇAIS

1. Ce symbole peut être associé au symbole chimique du mercure (Hg), du cadmium (Cd) ou du plomb (Pb) si la batterie contient plus de 0,0005% de mercure, 0,002% de cadmium ou 0,004% de plomb.
2. Toutes les piles et batteries doivent être collectées séparément et emportées par les services de voirie municipaux vers des intallations spécifiques de collecte des déchets, identifiées en conséquence par le gouvernement ou par les autorités locales.
3. Le traitement correct de vos piles ou batteries usagées contribue à protéger l'environnement et la santé des personnes et des animaux.
4. Pour plus d'informations sur le traitement de vos piles ou batteries usagées, merci de bien vouloir vous adresser à votre mairie, au service de la voirie ou au magasin où vous avez acheté le produit. (<http://www.lg.com/global/sustainability/environment/take-back-recycling/global-network-europe>)

ITALIANO

1. Questo simbolo può essere combinato con i simboli di mercurio (Hg), cadmio (Cd) o piombo (Pb) se la batteria contiene più di 0,0005% di mercurio, 0,002% di cadmio 0,004% di piombo.
2. Tutte le batterie/accumulatori devono essere smaltiti separatamente dai rifiuti domestici e nei punti di raccolta designati dal governo o dalle autorità locali.

3. Il corretto smaltimento delle vecchie batterie/accumulatori consente di evitare conseguenze potenziali negative per l'ambiente e la salute umana.
4. Per informazioni più dettagliate relative allo smaltimento di vecchie batterie/accumulatori rivolgersi alla propria azienda di servizi ambientali o al servizio di smaltimento del negozio in cui avete acquistato il prodotto. (<http://www.lg.com/global/sustainability/environment/take-back-recycling/global-network-europe>)

SVENSKA

1. Denna symbol kan kombineras med de kemiska symbolerna för kvicksilver(Hg), kadmium(Cd) eller bly (Pb) om batteriet innehåller mer än, 0,0005% kvicksilver, 0,002% kadmium eller 0,004% bly.
2. Alla batterier/ackumulatorer skall hanteras åtskiljda från vanligt hushållsavfall och föras till för ändamålet avsedda uppsamlingsplatser utsedda av myndigheterna.
3. Rätt hantering av dina gamla batterier/ackumulatorer medverkar till att förhindra negativa konsekvenser för miljön, och för djurs och människors hälsa.
4. För mer detaljerad information om hanteringen av dina gamla batterier/ackumulatorer ber vi dig ta kontakt med myndigheterna där du bor, eller med affären där du köpt din apparat. (<http://www.lg.com/global/sustainability/environment/take-back-recycling/global-network-europe>)

NEDERLANDS

1. Dit symbool kan samen met de chemische symbolen voor kwik (Hg), cadmium (Cd) en lood (Pb) worden gebruikt als de batterij of de accu meer dan 0,0005% kwik, 0,002% cadmium of 0,004% lood bevat.
2. Batterijen en accu's moeten altijd gescheiden van het normale huisvuil worden afgevoerd via door de overheid aangewezen inzamelpunten.
3. Door lege batterijen en accu's op de juiste manier af te voeren, helpt u mogelijke negatieve gevolgen voor het milieu en de gezondheid van mens en dier te voorkomen.
4. Bel voor meer informatie over het afvoeren van lege batterijen en accu's de afdeling Milieudienst van het gemeentehuis van uw woonplaats, het dichtstbijzijnde erkende inleveradres of de winkel waar u het product hebt gekocht. (<http://www.lg.com/global/sustainability/environment/take-back-recycling/global-network-europe>)

SUOMI

1. Mikäli paristo tai akku sisältää yli 0,0005% elohopeaa, 0,002% kadmiumia tai yli 0,004% lyijyä, voi tämä symboli sisältää näiden kemiallisten aineiden lyhenteet kuten elohopea (Hg), kadmium (Cd) tai lyijy (Pb).
2. Kaikki paristot/akut tulisi hävittää erikseen kotitalousjätteestä, ja ne tulisi toimittaa hävitettäväksi valtion tai paikallisten viranomaisten osoittamaan keräyspisteeseen.
3. Käytettyjen paristojen/akkujen oikea hävitystapa auttaa estämään mahdollisia negatiivisia vaikutuksia ympäristölle, eläin- ja ihmisterveydelle.
4. Käytettyjen paristojen/akkujen hävityksestä saat lisätietoja ottamalla yhteyttä paikallisiin viranomaisiin, jätteenkäsittely-yhtiöön tai tuotteen hankintapaikkaan. (<http://www.lg.com/global/sustainability/environment/take-back-recycling/global-network-europe>)

DEUTSCH

1. Dieses Symbol kann mit chemischen Symbolen für Quecksilber (Hg), Kadmium (Cd) oder Blei kombiniert sein, wenn die Batterie mehr als 0,0005 % Quecksilber, 0,002 % Kadmium oder 0,004 % Blei enthält.
2. Alle Batterien/Akkus sollten getrennt vom Hausmüll über die ausgewiesenen Sammelstellen entsorgt werden, die von staatlichen oder regionalen Behörden dazu bestimmt wurden.
3. Die ordnungsgemäße Entsorgung Ihrer alten Batterien/Akkus hilft bei der Vermeidung möglicher negativer Folgen für Mensch, Tier und Umwelt.
4. Beim Wunsch nach ausführlicheren Informationen über die Entsorgung Ihrer alten Batterien/Akkus wenden Sie sich bitte an Ihre Stadt- / oder Gemeindeverwaltung, die für Sie zuständige Abfallbehörde oder das Geschäft, in dem Sie das Produkt gekauft haben. (<http://www.lg.com/global/sustainability/environment/take-back-recycling/global-network-europe>)

DANSK

1. Symbolet kan være kombineret med de kemiske symboler for kviksølv (Hg), kadmium (Cd) eller bly (Pb), hvis batteriet indeholder mere end 0,0005% kviksølv, 0,002% kadmium eller 0,004% bly.
2. Alle batterier/akkumulatorer bør bortskaffes på separat vis, og ikke som husholdningsaffald, men via specielle opsamlingssteder, der er udpeget af de offentlige eller lokale myndigheder.
3. Når du bortskaffer dine gamle batterier/akkumulatorer på korrekt vis, hjælper du med til at forhindre mulige negative konsekvenser på miljøet samt på dyrs og menneskers sundhed.
4. Ønsker du yderligere oplysninger om bortskaffelse af dine gamle batterier/akkumulatorer, skal du kontakte de offentlige myndigheder, genbrugspladsen eller butikken, hvor du købte produktet. (<http://www.lg.com/global/sustainability/environment/take-back-recycling/global-network-europe>)

ΕΛΛΗΝΙΚΑ

1. Αυτό το σύμβολο ενδέχεται να συνδυάζεται με χημικά σύμβολα για υδράργυρο (Hg), κάδμιο (Cd) ή μόλυβδο (Pb) εάν η μπαταρία περιέχει περισσότερο από 0,0005% υδράργυρο, 0,002% κάδμιο ή 0,004% μόλυβδο.
2. Όλες οι μπαταρίες / συσσωρευτές θα πρέπει να απορρίπτονται χωριστά από τα οικιακά απορρίμματα στις προβλεπόμενες εγκαταστάσεις συλλογής που έχει δημιουργήσει το κράτος ή οι τοπικές αρχές
3. Η σωστή απόρριψη των παλαιών μπαταριών / συσσωρευτών συμβάλλει στην πρόληψη αρνητικών επιπτώσεων για το περιβάλλον, τα ζώα και την υγεία ανθρώπων.
4. Για αναλυτικότερες πληροφορίες σχετικά με την απόρριψη των παλιών μπαταριών / συσσωρευτών, επικοινωνήστε με το δημαρχείο σας, την υπηρεσία αποκομιδής απορριμμάτων ή το κατάστημα όπου αγοράσατε το προϊόν. (<http://www.lg.com/global/sustainability/environment/take-back-recycling/global-network-europe>)

ESPAÑOL

1. Este símbolo puede aparecer junto con símbolos químicos de mercurio (Hg), cadmio (Cd) o plomo (Pb) si la batería contiene más de un 0,0005% de mercurio, un 0,002% de cadmio o un 0,004% de plomo.
2. Las baterías o acumuladores no deberán tirarse junto con la basura convencional, sino a través de los puntos de recogida designados por el gobierno o las autoridades locales.
3. La correcta recogida y tratamiento de las baterías o acumuladores antiguos contribuye a evitar las potenciales consecuencias negativas para el medio ambiente, los animales y la salud pública.
4. Para más información sobre la eliminación de baterías o acumuladores antiguos, póngase en contacto con su ayuntamiento, el servicio de recogida de basuras o el comercio en el que adquirió el producto. (<http://www.lg.com/global/sustainability/environment/take-back-recycling/global-network-europe>)

CATALÀ

1. Aquest símbol pot combinar-se amb els símbols químics de mercuri (Hg), cadmi (Cd) o plom (Pb) si la bateria conté més de 0,0005 % de mercuri, 0,002 % de cadmi o 0,004 % de plom.
2. Totes les bateries o acumuladors s'han d'eliminar per separat del sistema de residus urbans a través de les instal·lacions de recollida designades pel govern o les autoritats locals.
3. L'eliminació correcta de les vostres bateries o dels acumuladors vells ajudarà a evitar possibles efectes negatius en el medi ambient i en la salut de les persones i dels animals.
4. Per obtenir informació més detallada sobre l'eliminació de les bateries o dels vostres acumuladors vells, contacteu amb l'oficina municipal, el servei de gestió de residus o la botiga on vau adquirir el producte. (<http://www.lg.com/global/sustainability/environment/take-back-recycling/global-network-europe>)

PORTUGUÊS

1. Este símbolo pode ser combinado com símbolos químicos para mercúrio (Hg), cádmio (Cd) ou chumbo (Pb) se a bateria contiver mais de 0,0005% de mercúrio, 0,002% de cádmio ou 0,004% de chumbo.
2. Todas as baterias/acumuladores devem ser eliminados em separado do lixo municipal através dos serviços de recolha designados pelas autoridades locais ou nacionais.

3. A eliminação correcta das baterias/acumuladores usadas ajuda a prevenir consequências negativas potenciais para o ambiente e para a saúde humana e animal.
4. Para informações mais detalhadas sobre a eliminação das suas baterias/acumuladores, contacte por favor os serviços de reciclagem locais, ou o local onde adquiriu o produto. (<http://www.lg.com/global/sustainability/environment/take-back-recycling/global-network-europe>)

SLOVENČINA

1. Tento symbol môže byť kombinovaný s chemickými symbolmi pre ortuť (Hg), kadmium (Cd) alebo olovo (Pb) v prípade, ak batéria obsahuje viac ako 0,0005 % ortuti, 0,002 % kadmia alebo 0,004 % olova.
2. Všetky batérie/akumulátory by sa mali likvidovať oddelene od komunálneho odpadu prostredníctvom určených zberných zariadení ustanovených štátnymi alebo miestnymi úradmi.
3. Správna likvidácia vašich starých batérií/akumulátorov pomôže zabrániť negatívnym následkom na životné prostredie, zdravotný stav ľudí a zvierat.
4. Viac informácií o likvidácii vašich starých batérií/akumulátorov vám poskytne váš mestský úrad, firma na likvidáciu odpadu alebo obchod, kde ste si výrobok kúpili. (<http://www.lg.com/global/sustainability/environment/take-back-recycling/global-network-europe>)

ČESKY

1. Tento symbol může být kombinován s chemickou značkou rtuti (Hg), kadmia (Cd) nebo olova (Pb), pokud baterie obsahuje více než 0,0005 % rtuti, 0,002 % kadmia nebo 0,004 % olova.
2. Všechny baterie/akumulátory je nutno likvidovat odděleně od běžného domovního odpadu, využijte k tomu určená sběrná místa dle pokynů národních nebo místních úřadů.
3. Správná likvidace starých baterií/akumulátorů pomůže zabránit možným negativním dopadům na životní prostředí a zdraví lidí a zvířat.
4. Podrobnější informace o likvidaci starých baterií/akumulátorů vám sdělí váš místní úřad, zpracovatel odpadu nebo obchod, kde jste produkt zakoupili. (<http://www.lg.com/global/sustainability/environment/take-back-recycling/global-network-europe>)

HRVATSKI

1. Taj simbol može se pojaviti u kombinaciji s kemijskim simbolom za živu (Hg), kadmij (Cd) ili olovo (Pb) ako baterija sadrži više od 0,0005% žive, 0,002% kadmija ili 0,004% olova.
2. Sve baterije/akumulatore treba odvojiti od kućanskog otpada i odložiti ih na mjesto koje je za otpad odredila vlada ili lokalna uprava.
3. Ispravnim odlaganjem starih baterija/akumulatora sprječavate negativan utjecaj na okoliš, zdravlje životinja i ljudi.
4. Dodatne informacije o odlaganju starih baterija/akumulatora zatražite od gradske uprave, komunalne službe ili trgovine u kojoj ste kupili proizvod. (<http://www.lg.com/global/sustainability/environment/take-back-recycling/global-network-europe>)

MAGYAR

1. Ez a szimbólum a higany (Hg), a kadmium (Cd), illetve az ólom (Pb) vegyjelével is lehet kombinálva, ha az adott elem 0,0005%-nál több higanyt, 0,002%-nál több kadmiumot, illetve 0,004%-nál több ólmot tartalmaz.
2. Minden elemet/akkumulátort a háztartási hulladéktól elkülönítve kell kezelni, a kormány, illetve a helyi hatóságok által kijelölt gyűjtőlétesítményeken.
3. A régi elemek/akkumulátorok megfelelő hulladékkezelése segít megelőzni a környezetre, illetve állatok és emberek egészségére gyakorolt lehetséges negatív következményeket.
4. A régi elemek/akkumulátorok hulladékkezelésével kapcsolatos részletes tájékoztatásért forduljon az önkormányzat irodájához, a hulladékkezelő szolgálathoz, illetve ahhoz az üzlethez, ahol a terméket vásárolta. (<http://www.lg.com/global/sustainability/environment/take-back-recycling/global-network-europe>)

POLSKI

1. Symbol ten może znajdować się w obecności chemicznych oznaczeń rtęci (Hg), kadmu (Cd) lub ołowiu (Pb), jeżeli bateria zawiera ponad 0,0005% rtęci, 0,002% kadmu lub 0,004% ołowiu.
2. Wszystkie baterie/akumulatory powinny być utylizowane w oddzieleniu od innych odpadów komunalnych przez jednostki wyznaczone do tego celu przez władze rządowe lub lokalne.
3. Poprawna utylizacja zużytych baterii/akumulatorów pomoże zapobiec możliwym negatywnym wpływom na środowisko, zwierzęta i ludzkie zdrowie.
4. W celu uzyskania więcej informacji na temat utylizacji zużytych baterii/akumulatorów należy skontaktować się z lokalnym urzędem miasta, zakładem usług komunalnych lub sklepem, w którym produkt został zakupiony. (<http://www.lg.com/global/sustainability/environment/take-back-recycling/global-network-europe>)

EESTI

1. Seda sümbolit võbedad (Hg), kaadmiumi (Cd) või plii (Pb) keemiline tähis, kui patarei/aku sisaldab üle 0,0005% elavhõbedat, üle 0,002% kaadmiumi või üle 0,004% pliid.
2. Kõigi patareide/akude käitlemine peab toimuma olmeprügiveost eraldi, riiklikult või kohaliku omavalitsuse poolt määratud spetsiaalsete kogumispunktide kaudu.
3. Teie vanade patareide/akude nõuetekohane käitlemine aitab ära hoida võimalikke negatiivseid tagajärgi keskkonnale ja inimeste tervisele.
4. Täpsema teabe saamiseks oma vanade patareide/akude käitlemise kohta pöörduge palun kohaliku omavalitsuse/jäätmekäitlusettevõtte poole või kaupluse, kust te antud toote ostsite. (<http://www.lg.com/global/sustainability/environment/take-back-recycling/global-network-europe>)

LATVIEŠU

1. Šo simbolu var papildināt dzīvsudraba (Hg), kadmija (Cd) vai svina (Pb) ķīmisko elementu simboli, ja akumulators satur vairāk kā 0,0005% dzīvsudraba, 0,002% kadmija vai 0,004% svina.
2. Visas baterijas/akumulatori ir jālikvidē valsts vai pašvaldības nozīmētās speciālās atkritumu savākšanas vietās, atsevišķi no mājstarpniecības atkritumiem.
3. Pareizi atbrīvojoties no vecajām baterijām/akumulatoriem, tiks novērstas iespējami nelabvēlīgās sekas uz apkārtējo vidi un cilvēku veselību.
4. Lai saņemtu sīkāku informāciju par atbrīvošanos no vecajām baterijām/akumulatoriem, lūdzu, sazinieties ar savas pašvaldības biroju, atkritumu iznīcināšanas dienestu vai veikalu, kur nopirkāt šo izstrādājumu. (<http://www.lg.com/global/sustainability/environment/take-back-recycling/global-network-europe>)

LIETUVIŲ K.

1. Jeigu maitinimo elemente yra daugiau nei 0,0005 % gyvsidabrio, kadmio (Cd) arba 0,004 % švino, šis ženklas gali būti naudojamas kartu su cheminiai gyvsidabrio (Hg), 0,002% kadmio arba švino (Pb) ženklaais.
2. Visi maitinimo elementai/akumulatoriaus turi būti išmetami atskirai, ne su buitinėmis atliekomis; juos reikia atiduoti į tam skirtus surinkimo punktus, kuriuos įrengia vyriausybė arba vietos valdžios institucijos.
3. Tinkamai išmetę senus maitinimo elementus/akumulatorius, padėsite apsaugoti aplinką, gyvūnų ir žmonių sveikatą nuo galimų neigiamų padarinių.
4. Išsamesnės informacijos apie senų maitinimo elementų/akumuliatorių išmetimą teiraukitės savo miesto savivaldybės administracijoje, atliekų tvarkymo tarnyboje arba parduotuvėje, kurioje įsigijote šį gaminį. (<http://www.lg.com/global/sustainability/environment/take-back-recycling/global-network-europe>)

TÜRKÇE

1. Bu sembol pillerin %0,0005 oranında cıva, %0,002 oranında kadmiyum veya %0,004 oranında kurşun içermesi durumunda cıva (Hg), kadmiyum (Cd) veya kurşun (Pb) kimyasal sembolleri ile bir arada bulunabilir.
2. Tüm piller ve akümülatörler, normal atılan çöplerden ayrı olarak, hükümet veya yerel idareler tarafından belirlenmiş olan toplama merkezlerinde atılmalıdır.

3. Bu tip kullanılan pillerin/akümülatörlerin doğru olarak atılması hem çevreye hem de hayvan ve insan sağlığına verilebilecek potansiyel olumsuz sonuçları önleyecektir.
4. Kullanılmış pillerinizin/akümülatörlerinizin atılması ile ilgili olarak, bulunduğunuz yerdeki belediye, çöp atım hizmeti veren kuruluşlara veya ürünü satın aldığınız yerlere başvurabilirsiniz. (<http://www.lg.com/global/sustainability/environment/take-back-recycling/global-network-europe>)

SLOVENŠČINA

1. Simbolu so lahko dodane tudi kemične oznake za živo srebro (Hg), kadmij (Cd) ali svinec (Pb), če baterija vsebuje več kot 0,0005 % živega srebra, 0,002 % kadmija ali 0,004 % svinca.
2. Vse baterije/akumulatorje odstranjujte ločeno od običajnih komunalnih odpadkov na namenskih zbirnih mestih, ki jih določijo vlada ali krajevne oblasti.
3. S pravilnim odlaganjem starih baterij/akumulatorjev pomagajte preprečevati negativne posledice za okolje ter zdravje ljudi in živali.
4. Podrobnejše informacije o odstranjevanju starih baterij/akumulatorjev poiščite pri mestnem uradu, komunalni službi ali prodajalni, kjer ste izdelke kupili. (<http://www.lg.com/global/sustainability/environment/take-back-recycling/global-network-europe>)

БЪЛГАРСКИ

1. Ако батерията съдържа над 0,0005% живак, 0,002% кадмий или 0,004% олово, този символ може да е придружен от химически знак, обозначаващи живак (Hg), кадмий (Cd) или олово (Pb).
2. Всички батерии/акумулатори трябва да бъдат изхвърляни отделно от битовите отпадъци чрез определени за това от правителството и местните власти съоръжения.
3. Правилното изхвърляне на непотребните батерии/акумулатори ще помогне за предотвратяване на възможни негативни последици за околната среда, животните и човешкото здраве.
4. За по-подробна информация за изхвърлянето на непотребни батерии/акумулатори се обърнете към местната община, услугите по изхвърляне на отпадъци или магазина, откъдето сте закупили продукта. (<http://www.lg.com/global/sustainability/environment/take-back-recycling/global-network-europe>)

ROMÂNĂ

1. Acest simbol poate fi asociat cu simboluri de elemente chimice pentru mercur(Hg), cadmiu(Cd) sau plumb(Pb) dacă bateria conține o cantitate mai mare de 0,0005% de mercur, 0,002% de cadmiu sau 0,004% de plumb.
2. Toate bateriile/acumuloarele trebuie eliminate separat de deșeurile menajere municipale prin unități de colectare dedicate, desemnate de guvern sau de autoritățile locale.
3. Eliminarea corectă a vechilor dvs. baterii/acumuloare va ajuta la prevenirea potențialelor consecințe negative asupra mediului înconjurător și sănătății oamenilor.
4. Pentru informații mai detaliate despre eliminarea vechilor dvs. baterii/acumuloare, contactați biroul local, serviciul de eliminare a deșeurilor sau magazinul de la care ați achiziționat produsul. (<http://www.lg.com/global/sustainability/environment/take-back-recycling/global-network-europe>)

NORSK

1. Dette symbolet kan være kombinert med de kjemiske tegnene for kvikksølv (Hg), kadmium (Cd) eller bly (Pb) hvis batteriene inneholder mer enn 0,0005 % kvikksølv, 0,002 % kadmium eller 0,004 % bly.
2. Alle batterier/akkumulatorer skal kastes atskilt fra restavfall og leveres ved offentlige spesialavfallsstasjoner.
3. Riktig håndtering av brukte batterier/akkumulatorer som avfall bidrar til å forhindre skader på miljøet og dyrs og menneskers helse.
4. Hvis du vil ha mer informasjon om hvordan du bør håndtere brukte batterier/akkumulatorer som avfall, kan du ta kontakt med lokale myndigheter, renovasjonstjenesten på stedet eller butikken der du kjøpte produktet. (<http://www.lg.com/global/sustainability/environment/take-back-recycling/global-network-europe>)

SRPSKI

1. Simbol može biti kombinovan sa hemijskim simbolima za živu (Hg), kadmijum (Cd) ili olovo (Pb) ako baterija sadrži više od 0,0005% žive, 0,002% kadmijuma ili 0,004% olova.
2. Sve baterije/akumulatore treba odložiti odvojeno od opšteg gradskog otpada, i to preko namenskih tačaka za prikupljanje, ustanovljenih od strane vlade ili lokalne uprave.
3. Ispravnim odlaganjem starih baterija/akumulatora sprečavate potencijalne negativne efekte na okolinu, zdravlje životinja i ljudi.
4. Dodatne informacije o odlaganju starih baterija/akumulatora zatražite od gradske uprave, komunalnog preduzeća ili prodavnice u kojoj ste kupili proizvod. (<http://www.lg.com/global/sustainability/environment/take-back-recycling/global-network-europe>)

РУССКИЙ

1. Данный символ может быть совмещен со значком химического элемента: ртути(Hg), кадмия(Cd) или свинца(Pb), если батарея содержит более 0,0005% ртути, 0,002% кадмия или 0,004% свинца.
2. Все аккумуляторы и батареи следует утилизировать отдельно от бытового мусора, в специальных местах сбора, назначенных правительственными или местными органами власти.
3. Правильная утилизация старых батарей и аккумуляторов поможет предотвратить потенциально вредное воздействие на окружающую среду и здоровье человека.
4. Для получения более подробных сведений об утилизации батарей и аккумуляторов обратитесь в администрацию города, службу, занимающуюся утилизацией или в магазин, где был приобретен продукт. (<http://www.lg.com/global/sustainability/environment/take-back-recycling/global-network-europe>)

МАКЕДОНСКИ

1. Овој симбол може да биде комбиниран со хемиските симболи за жива(Hg), кадмиум(Cd) или олово(Pb) ако батеријата содржи повеќе од 0,0005% жива, 0,002% кадмиум или 0,004% олово.
2. Сите батерии/акумулатори треба да бидат отстранети одделно од другиот отпад, на посебни места назначени од страна на владата или локалните власти.
3. Правилното отстранување на вашите стари батерии/акумулатори ќе ги спречи потенцијалните негативни последици за околината, животните и здравјето на луѓето.
4. За повеќе информации околу отстранувањето на вашите стари батерии/акумулатори, ве молиме обратете се до локалните власти, службата за отстранување отпад или продавницата од која сте го купиле производот. (<http://www.lg.com/global/sustainability/environment/take-back-recycling/global-network-europe>)

For Equipment under battery regulation



ENGLISH

- The battery is in compliance with the Regulation (EU) 2023/1542

DEUTSCH

- Die Batterie entspricht der Verordnung (EU) 2023/1542

FRANÇAIS

- La pile est conforme à la réglementation (UE) 2023/1542

ITALIANO

- La batteria è conforme al Regolamento (UE) 2023/1542

ESPAÑOL

- La pila cumple con el Reglamento (UE) 2023/1542

CATALÀ

- La bateria compleix el Reglament (UE) 2023/1542

PORTUGUÊS

- A bateria está em conformidade com o Regulamento (EU) 2023/1542

NEDERLANDS

- Deze accu voldoet aan de verordening (EU) 2023/1542

ΕΛΛΗΝΙΚΑ

- Η μπαταρία συμμορφώνεται με τον κανονισμό (ΕΕ) 2023/1542

MAGYAR

- Az akkumulátor megfelel az (EU) 2023/1542 rendeletnek

POLSKI

- Bateria spełnia wymogi rozporządzenia (UE) 2023/1542

ČESKY

- Baterie odpovídá Nařízení (EU) 2023/1542

SLOVENČINA

- Batéria je v súlade s nariadením (EÚ) 2023/1542

ROMÂNĂ

- Bateria este în conformitate cu Regulamentul (UE) 2023/1542

БЪЛГАРСКИ

- Батерията е в съответствие с Регламент (ЕС) 2023/1542

SVENSKA

- Batteriet överensstämmer med förordning (EU) 2023/1542

NORSK

- Batteriet overholder forordningen (EU) 2023/1542

DANSK

- Batteriet er i overensstemmelse med forordning (EU) 2023/1542

SUOMI

- Akku tai paristo on asetuksen (EU) 2023/1542 vaatimusten mukainen

EESTI

- Aku vastab määrusele (EL) 2023/1542

LIETUVIŲ K.

- Baterija atitinka Reglamentą (ES) 2023/1542

LATVIEŠU

- Akumulators ir atbilstīgs Regulai (ES) 2023/1542.

SLOVENŠČINA

- Baterija je v skladu z Uredbo (EU) 2023/1542.

SRPSKI

- Baterija je u skladu sa Uredbom (EU) 2023/1542.

HRVATSKI

- Baterija je u skladu s Uredbom (EU) 2023/1542.

РУССКИЙ

- Элемент питания соответствует требованиям Регламента (ЕС) 2023/1542.

МАКЕДОНСКИ

- Батеријата е во согласност со Регулотивата (ЕУ) 2023/1542.

TÜRKÇE

- Pil, (AB) 2023/1542 sayılı Yönetmelik ile uyumludur

Removal of waste batteries and accumulators (Product with embedded battery ONLY)

ENGLISH

- **Removal of waste batteries and accumulators (Product with embedded battery ONLY)**

In case this product contains a battery incorporated within the product which cannot be readily removed by end-users, LG recommends that only qualified professionals remove the battery, either for replacement or for recycling at the end of this product's working life. To prevent damage to the product, and for their own safety, users should not attempt to remove the battery and should contact LG Service Helpline, or other independent service providers for advice.

Removal of the battery will involve dismantling of the product case, disconnection of the electrical cables/contacts, and careful extraction of the battery cell. If you need the instructions for qualified professionals on how to remove the battery safely, please visit <http://www.lge.com/global/sustainability/environment/take-back-recycling>

DEUTSCH

- **Entfernen von Abfallbatterien und -Akkus (Nur für Produkte mit integrierter Batterie)**

Falls dieses Produkt eine im Produkt eingearbeitete Batterie/Akku enthält, die nicht ohne weiteres durch den Endbenutzer entfernt werden kann, empfiehlt LG, dass nur qualifizierte Fachkräfte Batterie oder Akku entfernen, die/der entweder wegen einer Ersatzlieferung oder für ein Recycling am Ende der Lebensdauer dieses Produkts ausgetauscht werden muss. Um Schäden am Produkt zu vermeiden, und für ihre eigene Sicherheit, sollten Benutzer nicht versuchen, Batterie oder Akku zu entfernen und diesbezüglich die LG-Beratungsstelle oder einen anderen unabhängigen Dienstleister zwecks Beratung kontaktieren.

Eine Entfernung der Batterie umfasst die Demontage des Produktgehäuses, das Trennen der elektrischen Kabel/Kontakte und eine vorsichtige Entnahme der Batteriezelle. Wenn Sie die Anweisungen für qualifizierte Fachkräfte benötigen, wie man Batterie/Akku sicher entfernen kann, besuchen Sie bitte <http://www.lge.com/global/sustainability/environment/take-back-recycling>

FRANÇAIS

- **Retrait de batteries et d'accumulateurs à mettre au rebut (produit avec batterie intégrée UNIQUEMENT)**

Dans le cas où ce produit contiendrait une batterie intégrée impossible à retirer facilement par les utilisateurs finaux, LG recommande de confier exclusivement à des professionnels qualifiés le soin de retirer la batterie, que ce soit pour la remplacer ou pour la recycler lorsque le produit est arrivée en fin de vie. Pour éviter d'endommager le produit et pour leur propre sécurité, les utilisateurs ne doivent pas tenter de retirer la batterie et ils doivent demander conseil à l'aide en ligne de LG Service ou à d'autres prestataires de services indépendants.

Le retrait de la batterie implique le démontage du boîtier du produit, la déconnexion des câbles/contacts électriques et l'extraction minutieuse de la cellule de la batterie. En allant sur <http://www.lge.com/global/sustainability/environment/take-back-recycling>, vous trouverez des instructions destinées aux professionnels qualifiés sur les procédures à employer pour retirer la batterie en toute sécurité.

ITALIANO

- **Rimozione di batterie e accumulatori (SOLO prodotti con batteria incorporata)**

Nel caso in cui il prodotto contenga una batteria incorporata nel prodotto che non può essere facilmente rimossa dall'utente finale, LG raccomanda che la batteria venga rimossa solo da professionisti qualificati, sia per la sostituzione sia per il riciclaggio al termine della vita del prodotto. Per evitare danni al prodotto, e per la propria sicurezza, gli utenti non devono tentare di rimuovere la batteria, ma contattare il Servizio clienti di LG o altri fornitori di servizi indipendenti per ottenere consiglio.

Per rimuovere la batteria, è necessario smontare la custodia del prodotto, scollegare i cavi/contatti elettrici ed estrarre delicatamente la batteria a bottone. In caso di bisogno di istruzioni per professionisti qualificati su come rimuovere la batteria in modo sicuro, si prega di visitare <http://www.lge.com/global/sustainability/environment/take-back-recycling>

ESPAÑOL

- **Eliminación de las baterías y acumuladores usados (SOLO para productos con batería integrada)**

En caso de que este producto contenga una batería incorporada que los usuarios finales no pueda retirar fácilmente, LG recomienda que sólo profesionales cualificados retiren la batería, ya sea para su sustitución que para reciclar la batería al final de la vida útil del producto.

Para evitar daños en el producto, y por su propia seguridad, el usuario no debe intentar retirar la batería, debe ponerse en contacto con la Línea de Ayuda de Servicios de LG, o con otros proveedores de servicios independientes para su asesoramiento.

La extracción de la batería implicará el desmontaje de la carcasa del producto, la desconexión de los cables/contactos eléctricos y la extracción cuidadosa de la celda de la batería. Si necesita instrucciones de profesionales cualificados sobre cómo retirar la batería de manera segura, por favor visite <http://www.lge.com/global/sustainability/environment/take-back-recycling>

CATALÀ

- **Eliminació de bateries i acumuladors usats (NOMÉS per a productes amb bateria integrada)**

En cas que aquest producte contingui una bateria integrada difícil d'extreure pels usuaris finals, LG recomana que l'extreguin només professionals qualificats, sigui per substituir-la o per reciclar-la al final de la vida útil d'aquest producte.

Per evitar danys en el producte i per la vostra seguretat, no heu d'intentar extreure la bateria. Poseu-vos en contacte amb el servei d'atenció al client d'LG o amb altres proveïdors de serveis independents perquè us assessorin.

L'extracció de la bateria implica desmuntar la carcassa del producte, desconnectar els cables o contactes elèctrics i extreure la bateria amb molt de compte. Si necessiteu les instruccions de professionals qualificats sobre com extreure la bateria de manera segura, visiteu <http://www.lge.com/global/sustainability/environment/take-back-recycling>

PORTUGUÊS

- **Remoção de resíduos de pilhas e acumuladores (APENAS produtos com bateria incorporada)**

No caso de este produto conter uma bateria incorporada que não possa ser removida prontamente pelos utilizadores finais, seja para substituição ou reciclagem no fim da vida útil deste produto, a LG recomenda que a sua remoção seja efetuada apenas por técnicos qualificados. Para evitar danificar o produto e para sua própria segurança, os utilizadores não deverão tentar remover a bateria, devendo contactar o Serviço de Assistência LG ou outros fornecedores de serviços independentes.

A remoção da bateria implica desmontar a caixa do produto, desligar os contactos/cabos elétricos e uma extrair cuidadosamente a célula da bateria. Se pretender obter instruções de técnicos qualificados sobre o modo de remoção seguro da bateria, visite <http://www.lge.com/global/sustainability/environment/take-back-recycling>

NEDERLANDS

- **Verwijdering van afgedankte batterijen en accu's (ALLEEN product ingebedde batterij)**

In het geval dat dit product een binnen het product opgenomen batterij bevat, die niet gemakkelijk kan worden verwijderd door eindgebruikers, raadt LG aan om de batterij alleen door gekwalificeerde professionals te laten verwijderen, zijnde voor vervanging of voor recycling aan het einde van de levensduur van dit product. Om schade aan het product te voorkomen, en voor hun eigen veiligheid, moeten gebruikers niet proberen om de batterij te verwijderen en moeten contact opnemen met de LG-servicehulplijn of andere onafhankelijke serviceproviders voor advies.

Om de batterij te verwijderen, moet de productbehuizing worden verwijderd, moeten de elektrische kabels/contacten worden losgekoppeld en moet de batterijcel voorzichtig worden uitgenomen. Als u de instructies voor gekwalificeerde professionals nodig hebt betreffende het veilig verwijderen van de batterij, gaat u naar <http://www.lge.com/global/sustainability/environment/take-back-recycling>

ΕΛΛΗΝΙΚΑ

- **Αφαίρεση χρησιμοποιημένων μπαταριών και συσσωρευτών (ΜΟΝΟ για το προϊόν με την ενσωματωμένη μπαταρία)**

Στην περίπτωση που το προϊόν διαθέτει ενσωματωμένη μπαταρία που δε μπορεί να αφαιρεθεί από το χρήστη, η LG σας προτείνει να απευθυνθείτε σε επαγγελματία για την αφαίρεση της μπαταρίας, εάν πρόκειται να την αντικαταστήσετε ή να τη στείλετε για ανακύκλωση στο τέλος της ζωής της. Για την πρόληψη βλάβης στο προϊόν, και για την ασφάλεια του χρήστη, μην επιχειρήσετε να αφαιρέσετε τη μπαταρία. Απευθυνθείτε στη Γραμμή Βοήθειας της LG, ή σε άλλο επαγγελματία.

Η αφαίρεση της μπαταρίας περιλαμβάνει αποσυναρμολόγηση της θήκης του προϊόντος, αποσύνδεση των ηλεκτρικών καλωδίων/επαφών και προσεκτική εξαγωγή των στοιχείων της μπαταρίας. Εάν χρειάζεστε τις επαγγελματικές οδηγίες για την αφαίρεση της μπαταρίας, επισκεφθείτε τη διεύθυνση <http://www.lge.com/global/sustainability/environment/take-back-recycling>

MAGYAR

- **Elhasználdott elemek és akkumulátorok eltávolítása (KIZÁRÓLAG beágyazott elemmel rendelkező termékek esetében)**

Ha a termék olyan beágyazott elemet tartalmaz, amelyet a termékből a végfelhasználó nem tud könnyedén eltávolítani, az LG azt javasolja, hogy elemcseréhez vagy a termék élettartamának végén az újrahaznosításhoz azt csak szakemberrel távolítsák el. A termék sérülésének megakadályozása és a saját biztonsága érdekében a felhasználók ne kíséreljék meg az elem eltávolítását, és tanácsadásért vegyék fel a kapcsolatot az LG Service segélyvonalával vagy más független szolgáltatóval.

Az akkumulátor eltávolítása magában foglalja a termék házának szétszerelését, az elektromos kábelek/érintkezők leválasztását és az akkumulátorcella gondos kihúzását. Ha szakember tanácsára van szüksége ahhoz, hogy biztonságosan távolítsa el az elemet, látogasson el a következő webhelyre: <http://www.lge.com/global/sustainability/environment/take-back-recycling>

POLSKI

- **Usowanie zużytych baterii i akumulatorów (Dotyczy TYLKO produktów z wbudowaną baterią)**

Jeśli ten produkt ma wbudowaną baterię, której konsument nie powinien usuwać samodzielnie, LG zaleca, aby usunięcie baterii (w celu jej wymiany lub recyklingu po zakończeniu cyklu życia produktu) zlecić osobie wykwalifikowanej. Aby uniknąć uszkodzenia produktu i ewentualnego niebezpieczeństwa, użytkownik nie powinien próbować usuwać baterii. Zamiast tego, powinien skontaktować się z LG Service Helpline lub innym niezależnym dostawcą usług w celu uzyskania porady.

Wyjęcie baterii zakłada demontaż obudowy produktu, odłączenie kabli/styków elektrycznych i ostrożne wyjęcie ogniwa akumulatora. Jeśli potrzebujesz instrukcji bezpiecznego usuwania baterii przeznaczonej dla wykwalifikowanych pracowników, odwiedź stronę <http://www.lge.com/global/sustainability/environment/take-back-recycling>

ČESKY

- **Vyjmutí starých baterií a akumulátorů (POUZE pro výrobek s integrovanou baterií)**

V případě, že tento výrobek obsahuje v produktu integrovanou baterii, kterou koncový uživatel nemůže snadno odstranit, je doporučeno společností LG, aby buď při výměně, nebo za účelem recyklace na konci životnosti tohoto produktu, bylo vyjmutí baterie ponecháno pouze kvalifikovaným odborníkům. Aby nedošlo k poškození výrobku, nebo

kvůli vlastní bezpečnosti by se uživatelé neměli pokoušet vyjmout baterii, ale naopak se obrátit o radu na servisní linku LG, nebo na jiné nezávislé poskytovatele služeb.

Vyjmutí baterie bude zahrnovat demontáž pouzdra produktu, odpojení elektrických kabelů/kontaktů a pečlivé vyjmutí baterie. Potřebujete-li pokyny pro kvalifikované odborníky o tom, jak bezpečně vyjmout baterii, navštivte prosím webové stránky <http://www.lge.com/global/sustainability/environment/take-back-recycling>

SLOVENČINA

• Vybratie odpadových batérií a akumulátorov (LEN produkt so vstavanou batériou)

V prípade, ak tento produkt obsahuje batériu vstavanú v produkte, ktorú nedokáže koncový používateľ jednoducho vybrať, spoločnosť LG odporúča, aby batériu na účel výmeny alebo recyklovania po skončení prevádzkovej životnosti tohto produktu vybrali kvalifikovaní odborníci. S cieľom zabrániť poškodeniu produktu a kvôli vlastnej bezpečnosti sa používatelia nesmú pokúšať vybrať batériu a o pomoc musia požiadať linku pomoci servisu LG alebo iných nezávislých poskytovateľov servisu.

Vybratie batérie bude zahŕňať demontáž krytu výrobku, odpojenie elektrických káblov/kontaktov a opatrné vybratie článku batérie. Ak potrebujete pokyny o spôsobe bezpečného vybratia batérie určené pre kvalifikovaných odborníkov, navštívte <http://www.lge.com/global/sustainability/environment/take-back-recycling>

ROMÂNĂ

• Eliminarea bateriilor uzate și acumulatorilor uzați (DOAR în cazul produselor cu baterie încorporată)

În cazul în care bateria este încorporată în produs și nu poate fi îndepărtată de utilizatorul final, LG recomandă ca bateria să fie îndepărtată doar de către un personal calificat; bateria astfel îndepărtată trebuie înlocuită și reciclată la sfârșitul duratei de viață a produsului. Pentru a preveni deteriorarea produsului și producerea oricărui accident, utilizatorilor li se recomandă să nu îndepărteze bateria, și să contacteze Serviciul de Asistență LG, sau orice altă unitate service individuală.

Înlăturarea bateriei presupune demontarea carcasei produsului, deconectarea cablurilor/contactelor electrice și extragerea cu atenție a celulei bateriei. Pentru instrucțiunile de îndepărtare în condiții de siguranță a bateriei, destinate personalului calificat, vă rugăm accesați <http://www.lge.com/global/sustainability/environment/take-back-recycling>

БЪЛГАРСКИ

• Изхвърляне на отпадъци съдържащи батерии и акумулатори (CAMO за продукти с вградена батерия)

В случай, че този продукт съдържа батерия включена в него, която не може лесно да бъде отстранена от крайните потребители, LG препоръчва само квалифицирани специалисти да изваждат батерията и да я заменят, и продуктът да се даде за рециклиране в края на работния си живот. За да предотвратят повреда на продукта, както и за собствената си безопасност, потребителите не трябва да се опитват да изваждат батерията и трябва да се свържат с LG Service „Гореща линия“, или други независими доставчици на услуги за съвет.

Изваждането на батерията включва демонтиране на кутията на продукта, изключване на електрическите кабели/контакти и внимателно изваждане на батерията. Ако имате нужда от инструкциите за квалифицирани специалисти относно това, как да извадите батерията безопасно, моля посетете: <http://www.lge.com/global/sustainability/environment/take-back-recycling>

SVENSKA

• Kassering av förbrukade batterier och ackumulatörer (Endast produkt med inbyggd batteri)

Om den här produkten innehåller ett batteri som sitter inbyggt i produkten och inte enkelt kan tas bort av användarna rekommenderar LG att endast behöriga personer tar ur batteriet, antingen för byte eller återvinning i slutet av produktens livslängd. För att förhindra skada på produkten och av säkerhetsskäl får användarna inte försöka ta ur batteriet och ska kontakta LG Service Helpline, eller en annan oberoende tjänsteleverantör för att få hjälp.

För att ta ut batteriet måste produktens chassi avlägsnas, elkablarna och kontakterna frånkopplas, varefter battericellen varsamt tas ut. Vid behov av instruktioner från behöriga fackmän kring hur batteriet avlägsnas på ett säkert sätt, besök sidan <http://www.lge.com/global/sustainability/environment/take-back-recycling>

NORSK

- **Fjerning av brukte batterier og akkumulatorer (KUN produkt med integrert batteri)**

I tilfelle dette produktet inneholder et batteri innlemmet i produktet som ikke enkelt kan fjernes av sluttbrukere, anbefaler LG at kun kvalifisert fagpersonale fjerner batteriet, enten for bytte eller for resikr ved slutten av dette produktets brukstid. For å unngå skade på produktet, og for deres egen sikkerhet, bør brukere ikke prøve å fjerne batteriet, og bør kontakte LG Service Helpline, eller andre uavhengige serviceleverandører for råd.

For å ta ut batteriet må produktkabinettet demonteres, de elektriske kablene/kontaktene må kobles fra og battericellen må tas forsiktig ut. Hvis du trenger instruksjonene for kvalifisert fagpersonale om hvordan batteriet fjernes trygt, gå til <http://www.lge.com/global/sustainability/environment/take-back-recycling>

DANSK

- **Fjernelse af opbrugte batterier og akkumulatorer (KUN produkter med integreret batteri)**

Hvis produktet har et indbygget batteri, som ikke nemt kan fjernes af slutbrugere, anbefaler LG, at batteriet kun bliver fjernet af kvalificerede teknikere, både hvis det er til udskiftning eller genbrug i slutning af produktets levetid. Med henblik på at forhindre skade på produktet og af hensyn til brugernes sikkerhed må sidstnævnte ikke selv forsøge at fjerne batteriet, og de bør kontakte LG Service Helpline eller en anden uafhængig serviceleverandør angående råd herom.

Når batteriet skal fjernes, bliver produktets kabinet afmonteret, de elektriske kabler/kontakter bliver afbrudt og battericellen omhyggeligt udtaget. Hvis du har brug for vejledningen for kvalificerede teknikere om, hvordan batteriet sikkert skal fjernes, kan du besøge <http://www.lge.com/global/sustainability/environment/take-back-recycling>

SUOMI

- **Käytettyjen paristojen/akkujen poisto (Tuote VAIN kiinteällä akulla)**

Tässä tapauksessa tuote pitää sisällään akun joka on liitetty kiinteästi tuotteeseen ja jota ei voida välittömästi poistaa loppukäyttäjien toimesta, LG suosittelee että vain pätevöitetyt ammattilaiset poistavat akun, joko vaihtoa varten tai kierrätettäväksi tämän tuotteen käyttöiän päätyttyä. Estääkseen tuotteelle tapahtuvaa vahinkoa ja taatakseen oman turvallisuutensa, käyttäjien ei pidä yrittää irrottaa akkua vaan ottaa yhteyttä LG-palvelulinjaan tai muuhun itsenäiseen palvelutoimittajaan saadakseen ohjeistusta.

Akun poisto käsittää tuotteen kotelon purkamisen, sähköjohtojen/-kontaktien irtikytkemisen sekä akkukennon huolellisen poistamisen. Jos tarvitset ohjeita pätevöitettyjä ammattilaisia varten koskien akun turvallista irrotusta, vieraile osoitteessa <http://www.lge.com/global/sustainability/environment/take-back-recycling>

EESTI

- **Kasutatud patareide ja akude eemaldamine (AINULT kaetud akudega toote korral)**

Juhul, kui tootel on toote sisemuses asuv aku, mida lõppkasutaja ei saa lihtsalt eemaldada, soovitab LG aku eemaldamiseks, nii vahetamise kui toote kasutusea lõppedes hävitamiseks, kasutada ainult kvalifitseeritud personali abi. Selleks, et vältida toote kahjustusi ning tagada enda ohutus, ei tohi kasutaja akut ise eemaldada ning abi saamiseks tuleb ühendust võtta LG teenuste kasutajatoega või mistahes muu edasimüüjaga

Aku eemaldamine hõlmab toote korpuse lahtivõtmist, elektriakaablite/kontaktide lahtihendamist ja akuelemendi hoolikat eemaldamist. Kui vajate aku ohutuks eemaldamiseks professionaalset abiinfot, külastage veebilehte <http://www.lge.com/global/sustainability/environment/take-back-recycling>

LIETUVIŲ K.

- **Baterijų ir akumuliatorių atliekų pašalinimas (TIK produktams su integruotu akumuliatoriumi)**

Jei šiam produktui įmontuotas akumuliatorius, kurio tiesioginis naudotojas lengvai pašalinti negali, „LG“ rekomenduojama kad akumuliatorių, jo keitimo atveju arba perdirbimo produkto tarnavimo laiko pabaigoje, pašalintų tik kvalifikuoti specialistai. Siekiant apsaugoti įrenginį nuo apgadinimo ir jūsų pačių saugumui, naudotojai neturėtų bandyti patys pašalinti akumuliatoriaus ir norėdami gauti patarimų turėtų susisiekti su „LG“ Paslaugų pagalbos linija ar kitais nepriklausomais paslaugų tiekėjais.

Išimant bateriją reikia išardyti gaminio korpusą, atjungti elektros kabelius / kontaktus ir atsargiai išimti baterijos elementą. Jei jums reikia kvalifikuotiems specialistams skirtų instrukcijų kaip saugiai pašalinti akumuliatorių, prašome apsilankyti <http://www.lge.com/global/sustainability/environment/take-back-recycling>

LATVIEŠU

• **Nederīgo bateriju un akumulatoru izņemšana (TIKAI produktiem ar iebūvētu akumulatoru)**

Ja šim produktam ir akumulators, kas iebūvēts produktā tā, ka gala lietotājs to nevar vienkārši izņemt, LG iesaka akumulatora izņemšanu nomaiņas vai pārstrādes nolūkos produkta dzīves cikla beigās uzticēt tikai kvalificētiem speciālistiem. Lai nenodarītu kaitējumu produktam un pasargātu sevi, lietotājiem nevajadzētu mēģināt izņemt akumulatoru un vajadzētu konsultēties ar LG palīdzības dienestu vai kādu neatkarīgu pakalpojumu sniedzēju.

Izņemot akumulatoru, nepieciešams demontēt produkta pārsegu, atvienot elektriskos kabeļus/savienojumus un uzmanīgi izņemt akumulatora elementu. Ja jums nepieciešamas kvalificētiem speciālistiem paredzētās norādes par akumulatora drošu izņemšanu, dodieties uz <http://www.lge.com/global/sustainability/environment/take-back-recycling>

SLOVENŠČINA

• **Odstranjanje odpadnih baterij in akumulatorjev (SAMO izdelki z vgrajeno baterijo)**

Če izdelek vsebuje v izdelek vgrajene baterije in jih končni uporabnik ne more zlahka odstraniti, vam LG priporoča, da poiščete pomoč usposobljenega strokovnjaka, bodisi za zamenjavo baterije ali za recikliranje ob koncu delovne dobe tega izdelka. Za preprečevanje poškodb na izdelku in varnost uporabnika, ne odstranjujte baterij sami, ampak si poiščite pomoč servisa LG Service Helpline, ali drugega neodvisnega servisa, ki nudi takšne storitve.

Odstranitev baterije bo vključevala razstavljanje ohišja izdelka, odklop električnih kablov/kontaktov in previdno odstranitev baterijske celice. Če potrebujete navodila za kvalificirane strokovnjake o tem, kako varno odstraniti baterijo, obiščite spletno stran <http://www.lge.com/global/sustainability/environment/take-back-recycling>

SRPSKI

• **Uklanjanje starih istrošenih baterija i akumulatora (JEDINO proizvod sa ugrađenom baterijom)**

U slučaju da ovaj proizvod sadrži bateriju koju krajnji korisnik ne može jednostavno da izvadi, LG preporučuje da to uradi samo kvalifikovana osoba, bilo da se radi o zameni ili recikliranju baterije nakon što se istroši. Kako bi se sprečio nastanak bilo kakvog oštećenja na proizvodu, a i zbog svoje lične sigurnosti, korisnici nikako ne treba da pokušavaju da sami izvade bateriju, već treba da pozovu LG pomoćni servis ili nekog drugog nezavisnog provajdera za savet.

Uklanjanje baterije će uključivati rastavljanje kućišta proizvoda, odspajanje električnih kablova/kontakta i pažljivo vađenje baterijske ćelije. Ako Vam je potrebna pomoć kvalifikovane osobe da biste videli kako se to radi, molimo Vas da pogledate veb stranicu <http://www.lge.com/global/sustainability/environment/take-back-recycling>

HRVATSKI

• **Uklanjanje potrošenih baterija/akumulatora (SAMO uređaji s ugrađenim baterijama/akumulatorima)**

U slučaju kada uređaj sadrži ugrađenu bateriju/akumulator unutar proizvoda koju ne može izvaditi krajni korisnik, LG preporučuje neka bateriju/akumulator izvadi samo kvalificirano osoblje, bilo radi zamjene ili recikliranja na kraju vijeka trajanja proizvoda. Radi sprječavanja oštećenja proizvoda i radi vlastite sigurnosti, korisnici ne smiju pokušavati izvaditi bateriju/akumulator i trebaju kontaktirati telefonsku liniju za pomoć LG servisa ili druge nezavisne pružatelje servisa i zatražiti savjet.

Uklanjanje baterije uključuje rastavljanje kućišta proizvoda, odspajanje električnih kabela/priključaka i pažljivo izvlačenje baterijske ćelije. Ako trebate upute kvalificiranih profesionalaca kako izvaditi bateriju na siguran način, molimo posjetite <http://www.lge.com/global/sustainability/environment/take-back-recycling>

МАКЕДОНСКИ

• **Отстранување на потрошените батерии и акумулатори (САМО производи со вградена батерија)**

Доколку производот содржи батерија што е вградена во производот и што не можат крајните корисници да ја отстранат, LG препорачува батеријата да ја отстранат само квалификувани професионални лица, било да е за менување или за рециклирање по истекот на животниот век на производот. За да спречат оштетувања на производот и поради нивна сопствена безбедност, корисниците не треба да се обидуваат да ја отстрануваат батеријата и треба да ја контактираат линијата за помош при услуги на LG или други независни испорачувачи на услуги.

Отстранувањето на батеријата ќе вклучи расклопување на кукиштето на производот, исклучување на електричните кабли/контакти и внимателно извлекување на батериската ќелија. Доколку ви се потребни инструкциите за квалификувани професионални лица за тоа како да ја отстраните батеријата безбедно, посетете ја веб-страницата <http://www.lge.com/global/sustainability/environment/take-back-recycling>

Product Specifications

PC Specifications

Display	15.6 inch IPS LCD or Touch LCD <ul style="list-style-type: none">• The display resolution may differ by model.
CPU	AMD Ryzen™ AI processor <ul style="list-style-type: none">• The CPU differs depending on model type and cannot be replaced by the user.
GPU	AMD Radeon™ 860M / 840M Graphics <ul style="list-style-type: none">• When processing large graphic data, it utilizes dynamically allocated system memory. The size of the allocated memory depends on the system memory size.• The GPU differs depending on model type and cannot be replaced by the user.
System Memory	LPDDR5x Onboard Memory <ul style="list-style-type: none">• Memory of 3 GB or more is supported only in a 64-bit O/S.• Memory size may differ depending on the model. The user must not arbitrarily replace or add the memory.
Storage Device	NVMe™-type SSD (M.2 2280) <ul style="list-style-type: none">• Storage device format and capacity may differ depending on the model.• The operation speed of the storage device may differ by model or slot where the storage device inside the model is mounted.
Bluetooth	Bluetooth 5.4 <ul style="list-style-type: none">• If you connect to Bluetooth device and wireless LAN at the same time, the system may become slow.• The indicated Bluetooth version is based on hardware. The version actually operated may differ by operation system and supported specifications of the connected Bluetooth device.
Wireless LAN	MediaTek Inc. MT7922A12L
Webcam	FHD IR Webcam
LAN	10/100 Megabit or Gigabit

- To use a wired LAN, you need to have a LAN adapter installed separately.
- The performance of the provided adapter depends on the model.

Product Weight	Approx. 2.84 lbs (battery included)
----------------	-------------------------------------

- Weight may vary depending on product configuration, color, and manufacturing conditions.

The product dimensions and specifications differ by model type and cannot be replaced by the user.

Power Supply and Environments

Adapter (Free Voltage)	Power Rating: Up to 65.0 W Input: AC 100 V to 240 V, 1.6 A 50 / 60 Hz Output: DC 5.0 V, 3.0 A / 9.0 V, 3.0 A / 15.0 V, 3.0 A / 20.0 V, 3.25 A
------------------------	---

Battery	Lithium Ion battery Charging Hours: 3.0 hours Charging hours may be longer if the battery is not used for a long time or the system is on. When temperature is outside the operating temperature specification, the battery may not be charged or charging hours may be longer. Operating temperature may be different from the actual room temperature.
---------	--

Operating and Storage Conditions	Operating Temperature: 50 °F to 95 °F Operating Humidity: 20 % RH to 80 % RH Storage Temperature: 23 °F to 104 °F Storage Humidity: 5 % RH to 90 % RH
----------------------------------	--

Power Consumption

Power consumption of this product during operation standby, sleep mode, and manual off modes may differ depending on the product specifications and the adapter type. Even when the system is turned off, it consumes a minute amount of power, if supplied. To cut off the power supply completely, disconnect the power cord from the power outlet.

To deactivate the Wireless network connection(ports) completely, shut down the system (select the Start button [] > [Power] > [Shut down]). When you turn on the system (by pressing the power button), it connects to the Wireless network connection(ports) again.

Limited Warranty

THE PRODUCT'S FULL LIMITED WARRANTY TERMS AND CONDITIONS ARE AVAILABLE AT [HTTPS://WWW.LG.COM](https://www.lg.com) AND/OR YOUR WARRANTY.

ARBITRATION NOTICE: THIS LIMITED WARRANTY CONTAINS AN ARBITRATION PROVISION THAT REQUIRES YOU AND LG ELECTRONICS ("LG") TO RESOLVE DISPUTES BY BINDING ARBITRATION INSTEAD OF IN COURT, UNLESS YOU

CHOOSE TO OPT OUT. IN ARBITRATION, CLASS ACTIONS AND JURY TRIALS ARE NOT PERMITTED. PLEASE SEE THE SECTION TITLED "PROCEDURE FOR RESOLVING DISPUTES" BELOW.

PROCEDURE FOR RESOLVING DISPUTES:

ALL DISPUTES BETWEEN YOU AND LG ARISING OUT OF OR RELATING IN ANY WAY TO THIS LIMITED WARRANTY OR THE PRODUCT SHALL BE RESOLVED EXCLUSIVELY THROUGH BINDING ARBITRATION, AND NOT IN A COURT OF GENERAL JURISDICTION. BINDING ARBITRATION MEANS THAT YOU AND LG ARE EACH WAIVING THE RIGHT TO A JURY TRIAL AND TO BRING OR PARTICIPATE IN A CLASS ACTION.

Definitions. For the purposes of this section, references to "LG" mean LG Electronics U.S.A., Inc., its parents, subsidiaries and affiliates, and each of their officers, directors, employees, agents, beneficiaries, predecessors in interest, successors, assigns and suppliers; references to "dispute" or "claim" shall include any dispute, claim or controversy of any kind whatsoever (whether based in contract, tort, statute, regulation, ordinance, fraud, misrepresentation or any other legal or equitable theory) arising out of or relating in any way to the sale, condition or performance of the product or this Limited Warranty.

Notice of Dispute. In the event you intend to commence an arbitration proceeding, you must first notify LG in writing at least 30 days in advance of initiating the arbitration by sending a letter to LG at LG Electronics, USA, Inc. Attn: Legal Department- Arbitration 111 Sylvan Avenue, Englewood Cliffs, NJ 07632. You and LG agree to engage in good faith discussions in an attempt to amicably resolve your claim. The notice must provide your name, address, and telephone number; identify the product that is the subject of the claim; and describe the nature of the claim and the relief being sought. If you and LG are unable to resolve the dispute within 30 days, either party may proceed to file a claim for arbitration.

Agreement to Binding Arbitration and Class Action Waiver. Upon failure to resolve the dispute during the 30 day period after sending written notice to LG, you and LG agree to resolve any claims between us only by binding arbitration on an individual basis, unless you opt out as provided below. Any dispute between you and LG shall not be combined or consolidated with a dispute involving any other person's or entity's product or claim. More specifically, without limitation of the foregoing, any dispute between you and LG shall not under any circumstances proceed as part of a class or representative action. Instead of arbitration, either party may bring an individual action in small claims court, but that small claims court action may not be brought on a class or representative basis.

Arbitration Rules and Procedures. To begin arbitration of a claim, either you or LG must make a written demand for arbitration. The arbitration will be administered by the American Arbitration Association ("AAA") and will be conducted before a single arbitrator under the AAA's Consumer Arbitration Rules that are in effect at the time the arbitration is initiated (referred to as the "AAA Rules") and under the procedures set forth in this section. The AAA Rules are available online at www.adr.org/consumer. Send a copy of your written demand for arbitration, as well as a copy of this provision, to the AAA in the manner described in the AAA Rules. You must also send a copy of your written demand to LG at LG Electronics, USA, Inc. Attn: Legal Department- Arbitration 111 Sylvan Avenue, Englewood Cliffs, NJ 07632. If there is a conflict between the AAA Rules and the rules set forth in this section, the rules set forth in this section will govern. This arbitration provision is governed by the Federal Arbitration Act. Judgment may be entered on the arbitrator's award in any court of competent jurisdiction. All issues are for the arbitrator to decide, except that issues relating to the scope and enforceability of the arbitration provision and to the arbitrability of the dispute are for the court to decide. The arbitrator is bound by the terms of this provision.

Governing Law. The law of the state of your residence shall govern this Limited Warranty and any disputes between us except to the extent that such law is preempted by or inconsistent with applicable federal law.

Fees/Costs. You do not need to pay any fee to begin an arbitration. Upon receipt of your written demand for arbitration, LG will promptly pay all arbitration filing fees to the AAA unless you seek more than \$25,000 in damages, in which case the payment of these fees will be governed by the AAA Rules. Except as otherwise provided for herein, LG will pay all AAA filing, administration and arbitrator fees for any arbitration initiated in accordance with the AAA Rules and this arbitration provision. If you prevail in the arbitration, LG will pay your attorneys' fees and expenses as long as they are reasonable, by considering factors including, but not limited to, the purchase amount and claim amount. Notwithstanding the foregoing, if applicable law allows for an award of reasonable attorneys' fees and expenses, an arbitrator can award them to the same extent that a court would. If the arbitrator finds either the substance of your claim or the relief sought in the demand is frivolous or brought for an improper purpose (as measured by the standards set forth in Federal Rule of Civil Procedure 11(b)), then the payment of all arbitration fees will be governed by the AAA Rules. In such a situation, you

agree to reimburse LG for all monies previously disbursed by it that are otherwise your obligation to pay under the AAA Rules. Except as otherwise provided for, LG waives any rights it may have to seek attorneys' fees and expenses from you if LG prevails in the arbitration.

Hearings and Location. If your claim is for \$25,000 or less, you may choose to have the arbitration conducted solely on the basis of (1) documents submitted to the arbitrator, (2) through a telephonic hearing, or (3) by an in-person hearing as established by the AAA Rules. If your claim exceeds \$25,000, the right to a hearing will be determined by the AAA Rules. Any in-person arbitration hearings will be held at a location within the federal judicial district in which you reside unless we both agree to another location or we agree to a telephonic arbitration.

Opt Out. . You may opt out of this dispute resolution procedure. If you opt out, neither you nor LG can require the other to participate in an arbitration proceeding. To opt out, you must send notice to LG no later than 30 calendar days from the date of the first consumer purchaser's purchase of the product by either: (i) sending an e-mail to optout@lge.com, with the subject line: "Arbitration Opt Out" or (ii) calling 1- 800-980-2973. You must include in the opt out e-mail or provide by telephone: (a) your name and address; (b) the date on which the product was purchased; (c) the product model name or model number; and (d) the serial number (the serial number can be found (i) on the product; or (ii) online by accessing <https://www.lg.com/us/support> and clicking on "How do I find my model number?").

You may only opt out of the dispute resolution procedure in the manner described above (that is, by e-mail or telephone); no other form of notice will be effective to opt out of this dispute resolution procedure.

Opting out of this dispute resolution procedure will not affect the coverage of the Limited Warranty in any way, and you will continue to enjoy the full benefits of the Limited Warranty. If you keep this product and do not opt out, then you accept all terms and conditions of the arbitration provision described above.

Using Windows 11

Windows Use Guide

The screen and menu configurations may differ from this manual depending on the status of the Windows update. You can check details on the use of Windows on <https://www.microsoft.com/windows/>.

Starting

Windows Screen Layout

The taskbar in Windows can be used so you can use Windows quickly and easily.

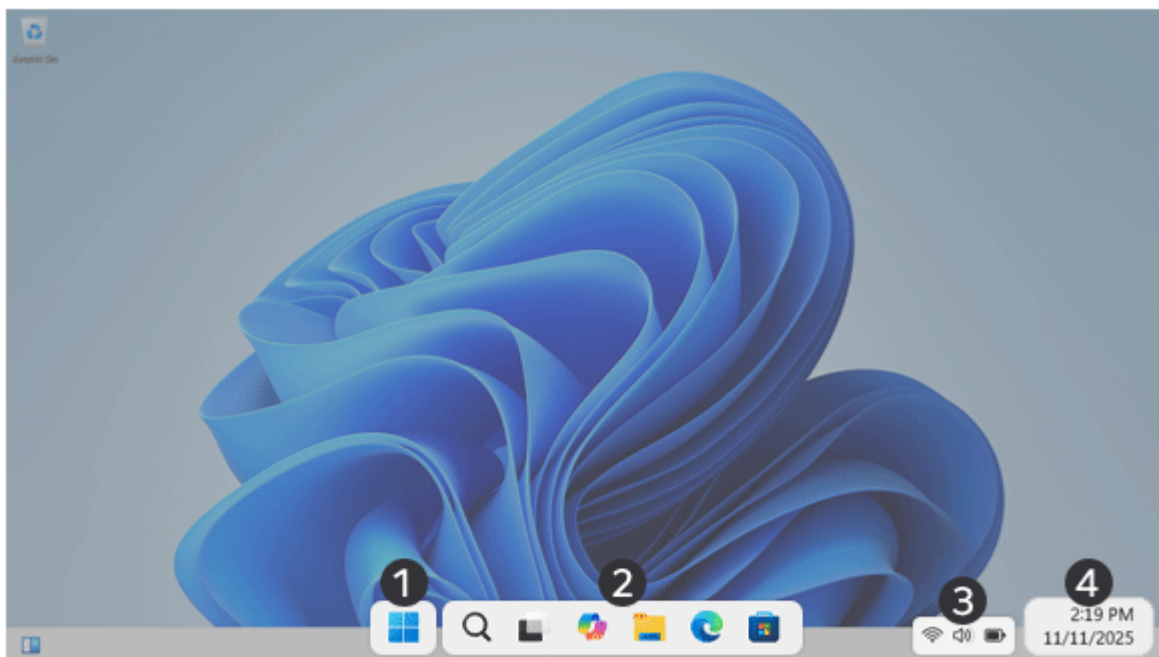

1. **Start Button:** Allows you to select and use the Search function and app on the home screen.
2. **Basic Features:** Allows you to use Search, File Explorer, Browser, Store, etc.
3. **Quick Settings:** Allows you to change the PC functions and settings easily.
4. **Notifications:** Allows you to check notifications regarding time, calendar, and system.

Start Screen

If you select the Start button [] on the taskbar, the Start screen will appear.



Tip:

Press the [] key or [Ctrl] + [Esc] on the keyboard to display the Start screen.

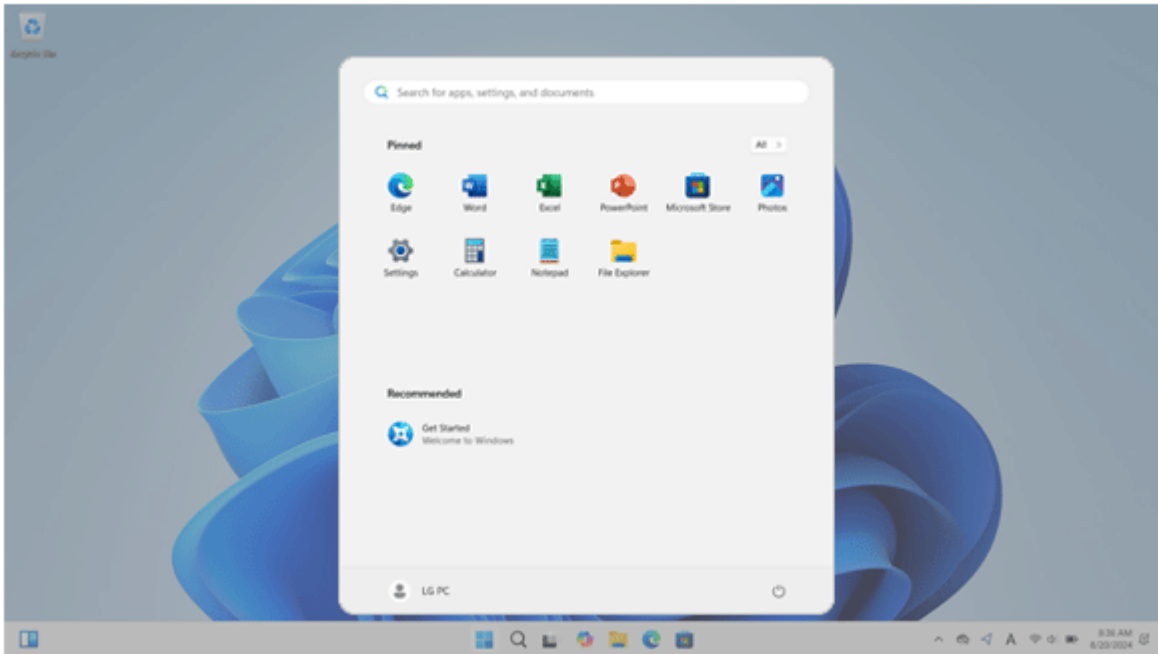

Using Apps

Running and Exiting Apps

Allows you to start an app you want on the Start screen.

1. Select the Start button [] and select and run the app you want.



Tip:

Press the [] key or [Ctrl] + [Esc] on the keyboard to display the Start screen.

Allows you to search and run the app name in the search window.

2. To close the app, select the Close button [] at the top of the app screen.

Deleting Apps

Allows you to delete an app you want on the Start screen.



Tip:

The basic Windows apps that are required may not be deleted.

The desktop app can be deleted by pressing the Start button [] > [Settings] > [Apps] > [Installed apps].

1. After selecting the Start button [], right-click the app you want to delete and select [Uninstall].



Tip:

Press the [] key or [Ctrl] + [Esc] on the keyboard to display the Start screen.

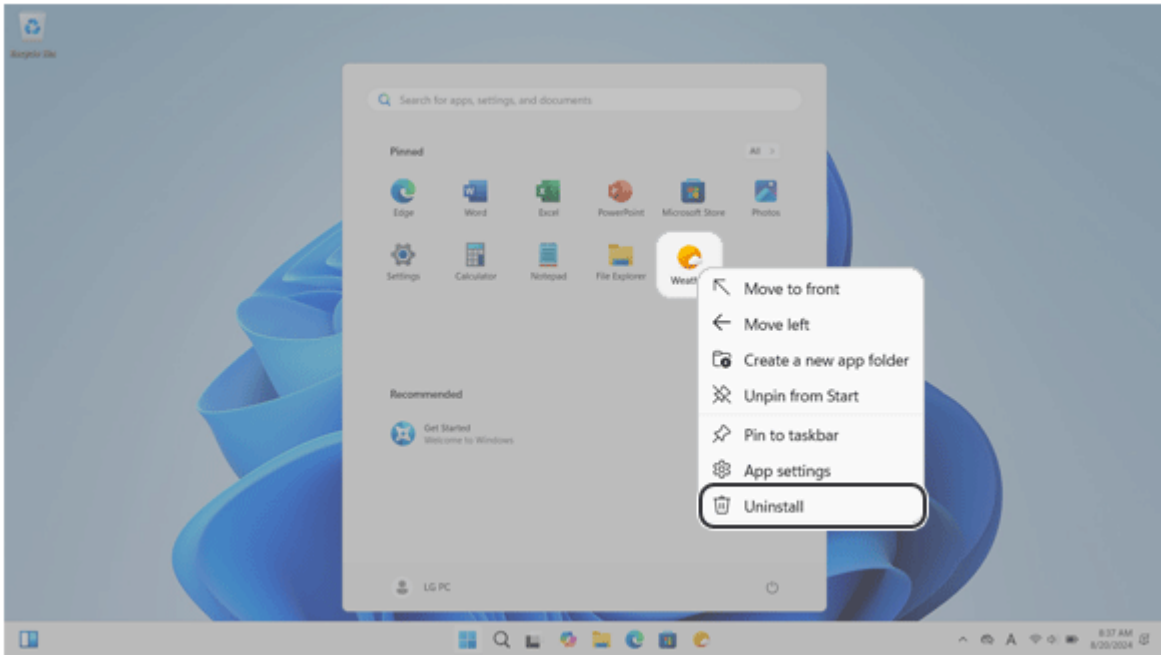

2. When prompted to confirm the deletion, select [Uninstall] to delete the app.

Adding Apps to Start Screen/Taskbar

You can add frequently used apps on the Start screen and taskbar for easy and quick access.

1. Select the Start button [] > [All].



Tip:

Press the [] key or [Ctrl] + [Esc] on the keyboard to display the Start screen.

2. Right-click the app you want to add and then click [Pin to Start] or [More] > [Pin to taskbar].

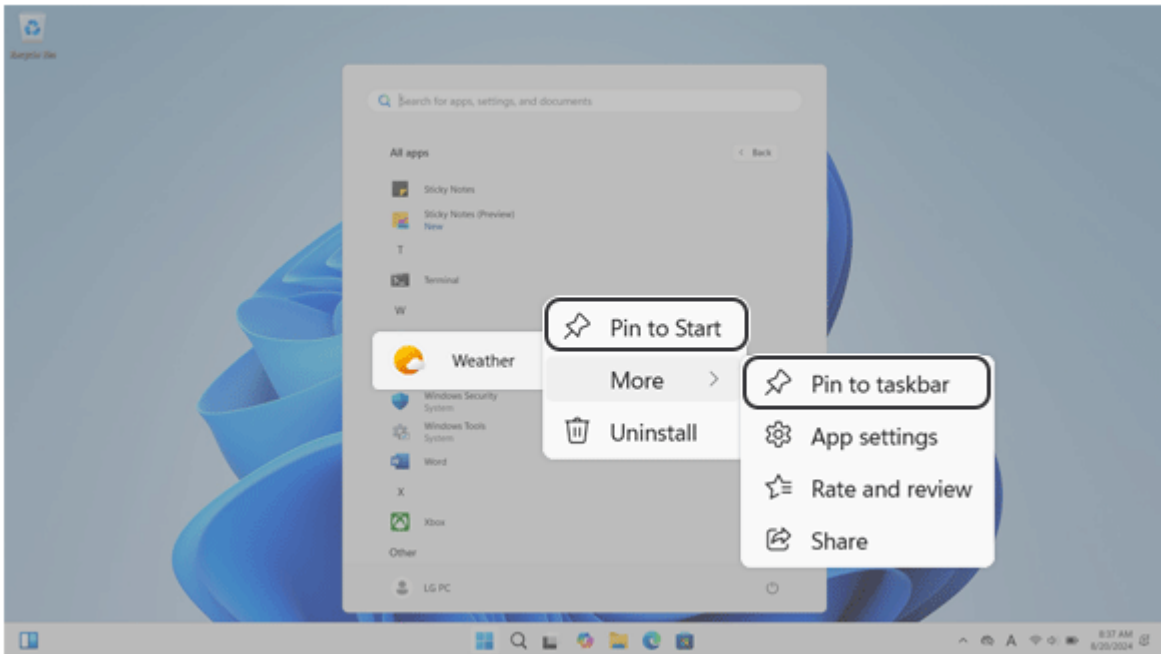

Using the Store

You can purchase a variety of apps or get free apps from Microsoft Store.



Tip:

If a local account is being used, a window to switch to a Microsoft account appears while using Windows Store. Follow the instructions on the screen to switch the local account to a Microsoft account.

You can also switch to Microsoft account by selecting Start button [] > [User Account] > [Manage my account].

If you switch to a Microsoft account, your PC settings (background, user settings, etc.) may be changed to the previous settings.

1. Select [] on the taskbar to run [Microsoft Store].
2. Select the app or use the search function on the store screen to install the desired app when the [Microsoft Store] screen appears.

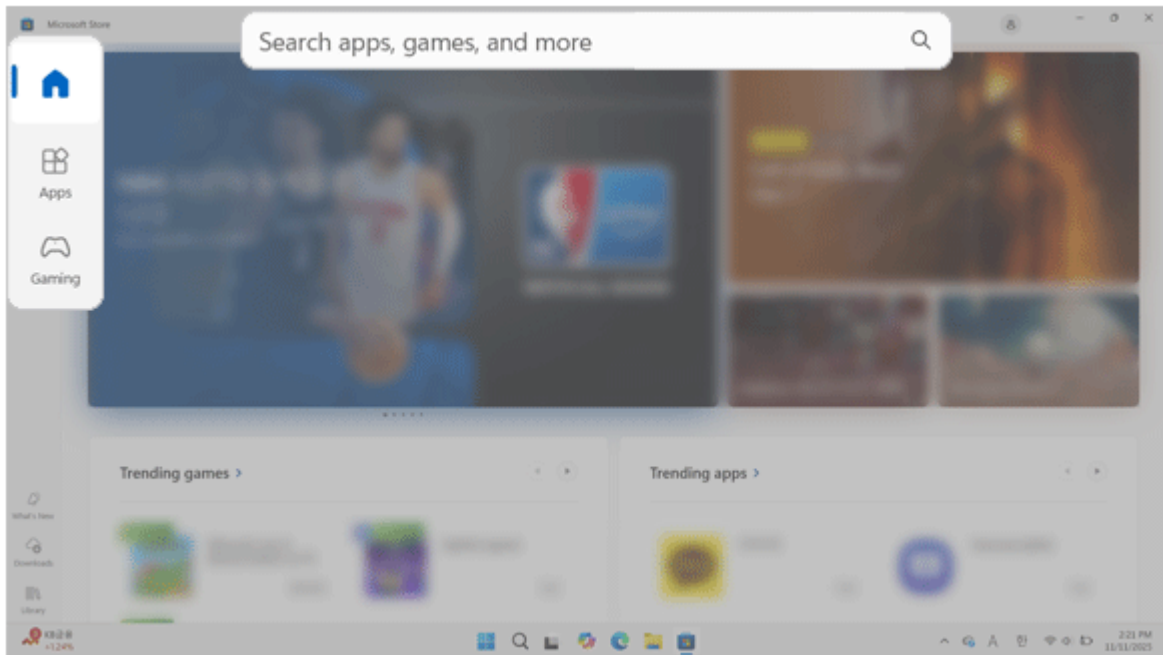

Unlocking the Screen

If the PC is not used for an extended period, it goes into a locked state.

When the PC is used again, a lock screen appears for security purposes and may be unlocked by using the following method.

1. Press any key in the keyboard or left-click the mouse on the lock screen.
2. If the login screen appears, enter the password.

(If no password is set, the screen will be released when you select the login.)

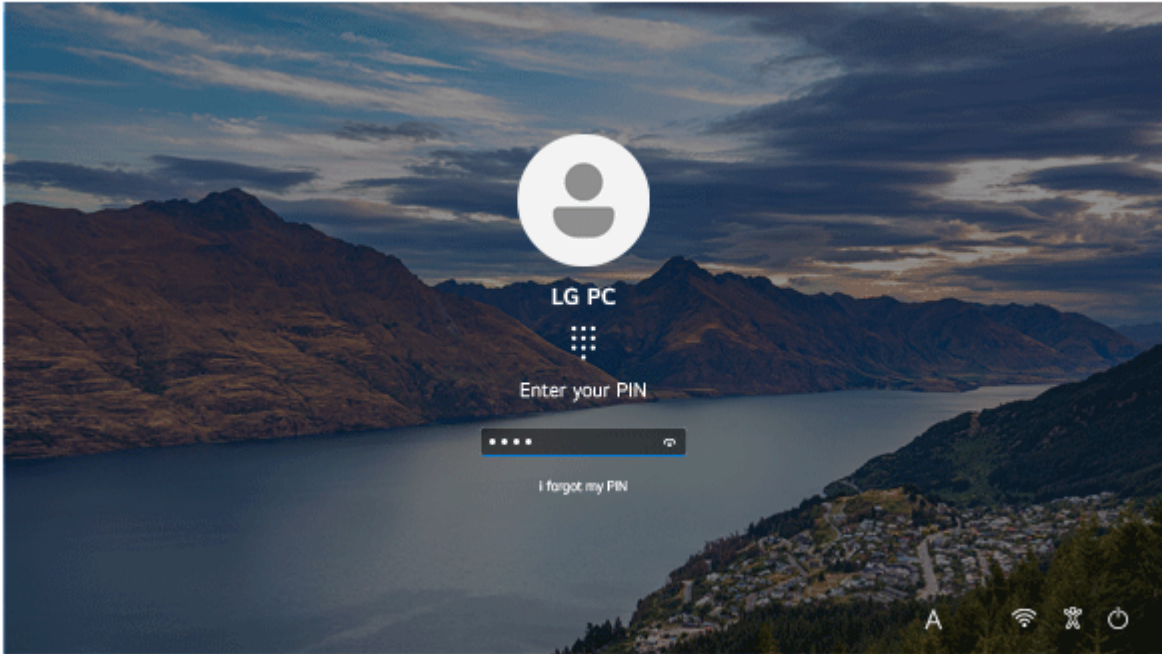

Setting the PC

Windows 11 supports various functions so that the user can change the PC setting easily and quickly.

Using the Setting Menu

1. Select the Start button [] > [Settings].

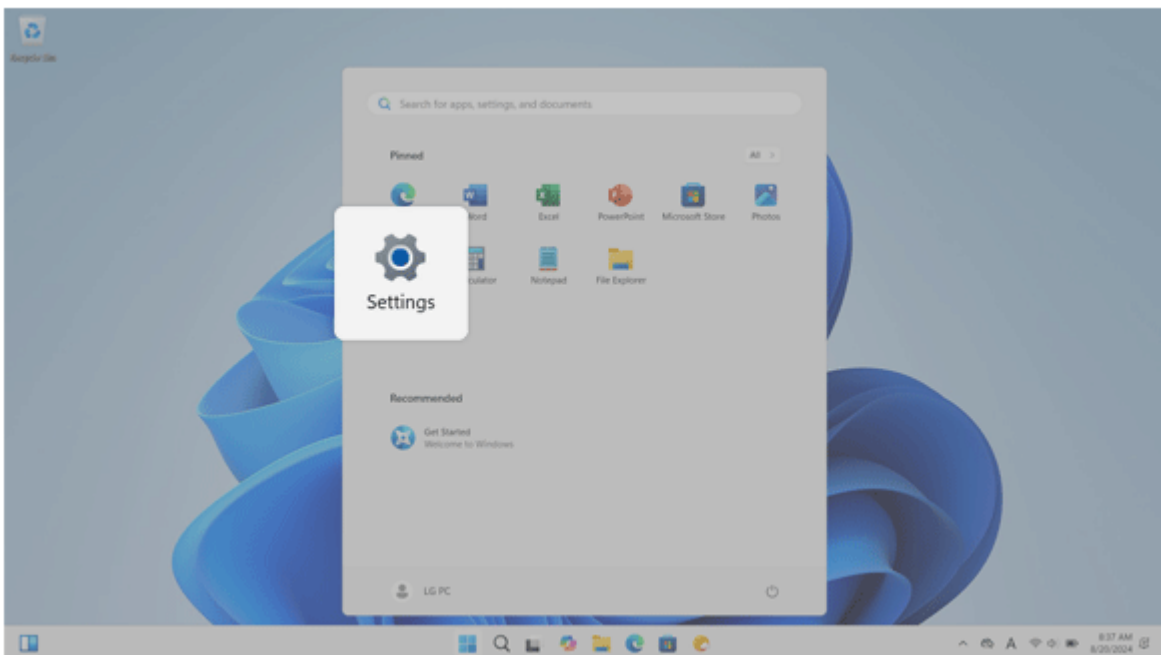

2. When the Settings screen appears, select and change the settings as needed.

Using the Quick Settings

Quick Settings allows users to change the PC settings quickly and easily.

1. Select [Quick Settings] on the right side of the taskbar.

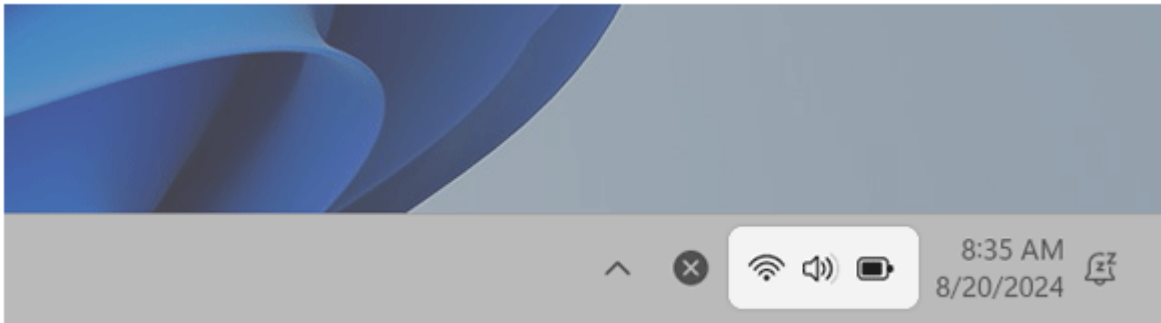

2. Select the desired setting from [Quick Settings] and change.

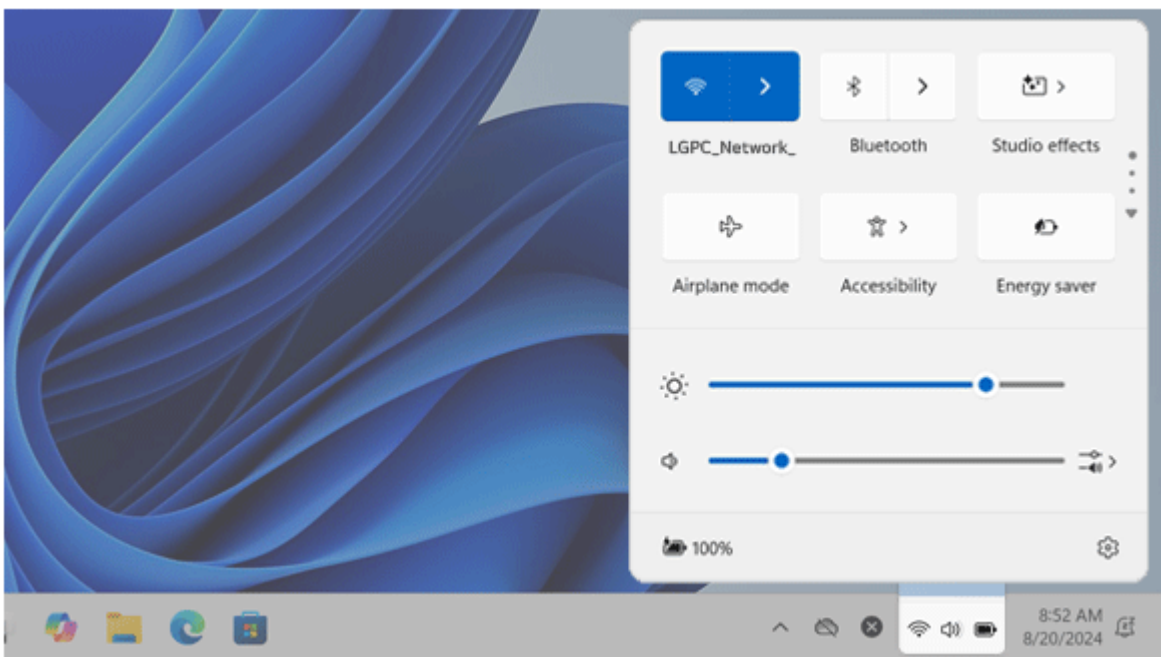

Tip:

Select the [] icon to run the [Settings] menu.

Windows Shutdown Option

In Windows 11, you can use the Windows shutdown option by following these steps:

1. Select the Start button [] > [Power] and select the desired Windows shutdown option.

 Tip:

Press the [] key or [Ctrl] + [Esc] on the keyboard to display the Start screen.

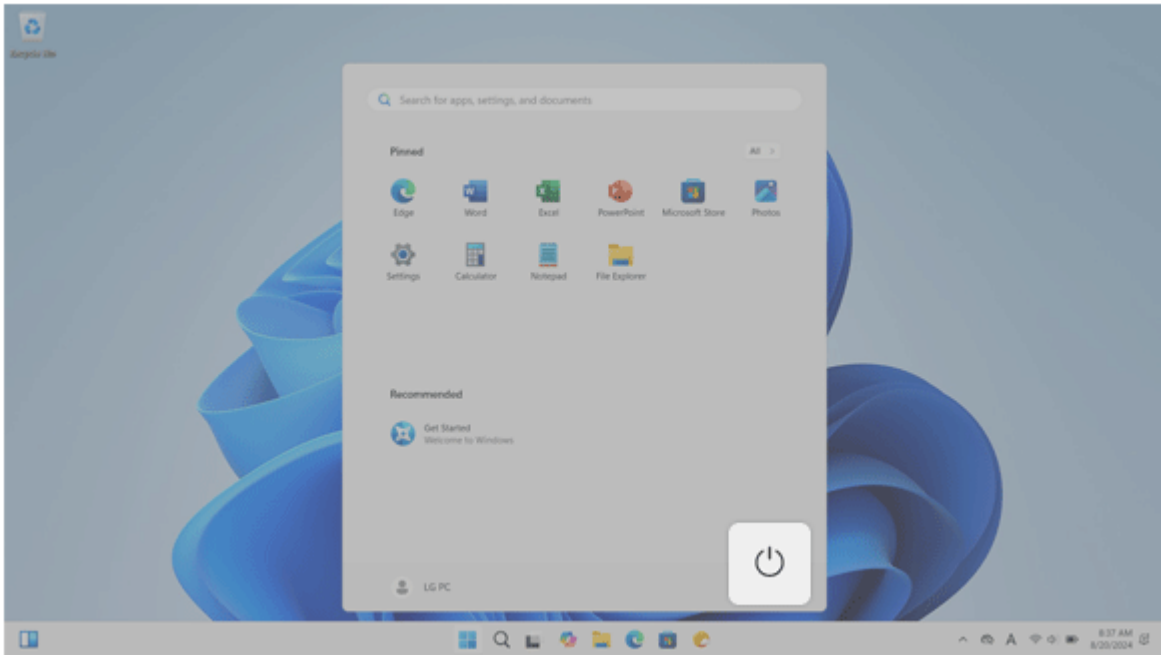

 Tip:

On the Desktop screen, press [Alt] + [F4] to use the Windows shutdown option.
(Pressing [Alt] + [F4] on a running app may end the app.)

Using the PC

Product Tour

The actual product may differ in shape and color from the product images included in this LG Easy Guide.

Front

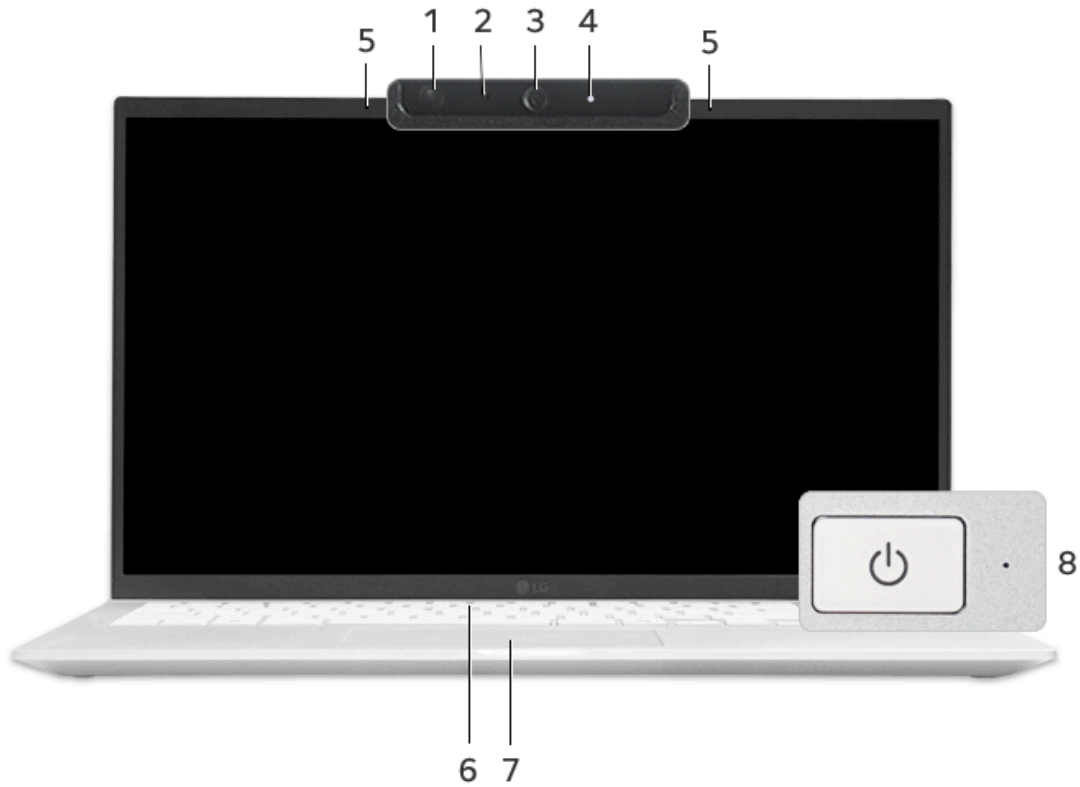

- 1. IR LED
- 2. IR Camera
- 3. Webcam
- 4. Webcam Operation Status Lamp
- 5. Built-in Microphone
- 6. Keyboard
- 7. Touchpad
- 8. Power Button []

Left

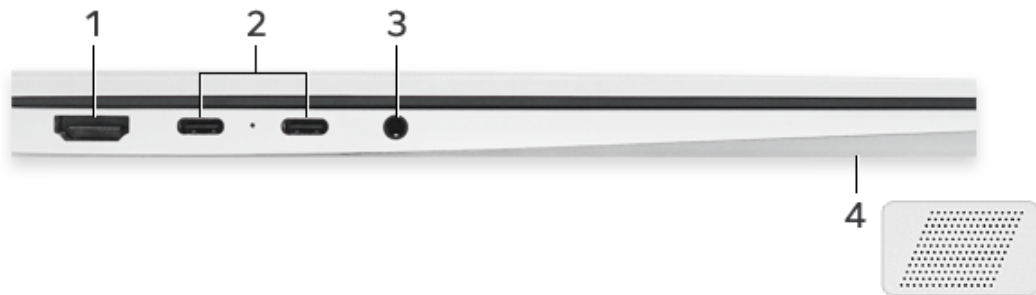

Right



1. HDMI Port
2. USB-C® Port (USB 3.2 Gen 2x1)
3. Headphone Port (4-pole Ear Microphone Port)
4. Built-in Speakers
5. USB Port (USB 3.2 Gen 1x1)
6. Security Keyhole (Kensington Security Slot)



Tip:

- The USB-C® port provides Quick Charging and Always-On Charging functions for devices that support USB PD (Power Delivery).
- When using ear microphone (or Bluetooth headset), audio input and output are directed to the connected device and the microphone and speaker on PC do not work.
The 4-pole ear microphone port does not support external microphone.

Battery Charge

Connect the adapter to power and charge the product.



Tip:

The power cable and the adapter type may differ per model type and country and there is no difference in functionality.

This product has a built-in battery pack. After purchasing your PC, be sure to charge the battery pack completely before using it for the first time.

The internal battery should not be arbitrarily disassembled or replaced. Arbitrarily disassembling the product may void the warranty.

If you need to disassemble or replace the battery, please contact the designated Call Center.

We charge a fee for removing or replacing the battery.

Charging a Battery

The adapter can be used from 100 V to 240 V.

1. Connect the power cable to the adapter main body, and connect the adapter to the power outlet.
2. Connect the power cable to the USB-C® port of the PC.

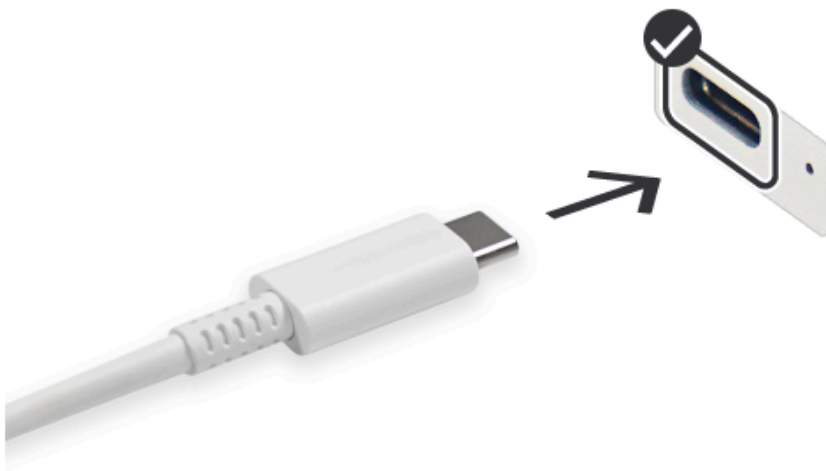

USB-C® port

3. Check the Adapter power lamp.

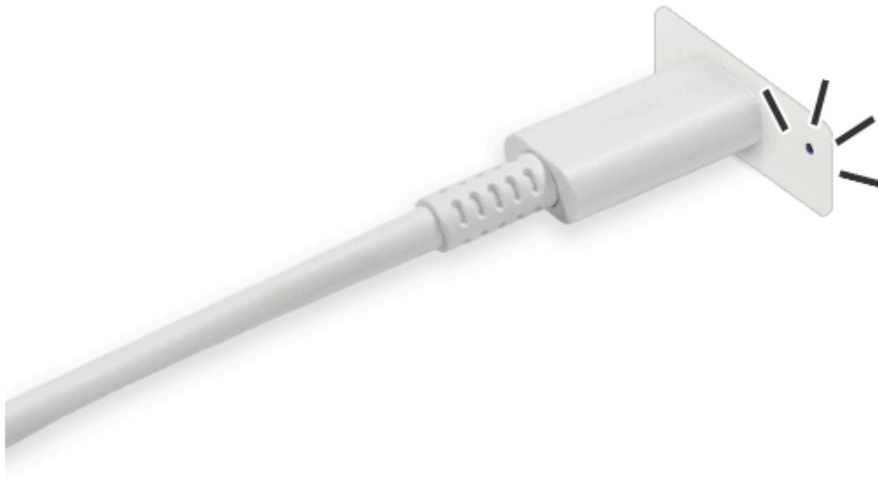

- On: When the adapter is connected and charging is complete
- Blinking: When the adapter is connected and is charging
- Off: When the adapter is not connected

If you try to turn on the system that has entered the Hibernate mode or been turned off after a low-battery alarm, the system will not be turned on but the lamp will blink three times. If this is the case, connect the adapter and charge the battery sufficiently before using it.



Caution:

Do not leave a liquid container on the PC.

- The system may be short-circuited and damaged.

Use batteries certified and acknowledged by LG Electronics Inc.

- Uncertified batteries may explode.



Warning:

Please use an adapter certified by LG Electronics Inc.

- Uncertified batteries may explode.
- It may cause a problem in battery charging or system operation.

When you use an adapter, follow the below directions.

- 140 °F or more high-humidity spaces, for example, inside cars or saunas, should be avoided when you use or store it.
- Do not disassemble or modify the adapter.
- Do not twist the adapter plug.
- When you connect the adapter, do not forcefully push the plug.

The battery may explode due to excessive heat, causing fire. For a safe and efficient use of battery, follow the below directions.



- Do not short-circuit the battery.
- Keep the battery out of reach of children.
- A visible swelling of the battery pack indicates a possible danger. When this occurs, contact your local vendor or call center immediately.
- Use only a certified and designated recharger.
- Keep the battery pack away from heat. (Never put it in a microwave.)
- Do not leave inside a car under the summer heat.
- Do not leave or use at a hot and humid place like a sauna.
- Do not use the machine placed on a heating blanket or other heat reserving materials.
- Do not leave the machine turned on inside a closed space.
- Make sure that the battery ports are not touched by any metallic objects like a key, coin, necklace, and watch.
- Use only a lithium secondary battery certified and guaranteed by mobile device manufactures.
- Do not disassemble or modify the battery. Do not compress or pierce the battery.
- Do not apply shock to the battery. For example, do not drop the battery from a high place.
- Keep the room temperature between 23 °F and 104 °F. Do not expose the PC to heat hotter than 140 °F.
- Keep the machine dry.
- Do not discard the battery arbitrarily as you are requested to follow the local procedure for discarding the battery.
- Before using this machine, read this guide carefully.



Tip:

When the PC is not to be used for a long period of time, refer to the following:

- Check the battery charge level on a regular basis and keep it at 50 %. This allows you to extend the battery life.
- If the battery is left fully charged for an extended period of time, the battery capacity and battery running time may be reduced.
- If the battery is left fully discharged for an extended period of time, it may become over-discharged and cannot be charged again.

For more efficient use of the battery, read the following carefully.

- The battery runs low naturally even if it is kept unused.
- To increase battery lifespan, use the battery for a while before charging it rather than keeping the battery completely charged.
- If you don't use the product for a long time with the battery completely discharged, the battery lifespan may decrease.

The battery capacity may change due to chemical reactions during charge and discharge.

- LG Notebook frequently checks the charge level of its battery based on usage conditions, and then calculates and correctly indicates the actual remaining level of the battery.
- The battery is wearable goods and thus the life span may become shorter with use. The battery running time may also become shorter accordingly.



- When the battery is fully charged, the machine stops recharging. It resumes recharging when the battery charge rate drops below 95 %. This feature secures the safe and efficient use of the battery.
- When the temperature of the battery drops below 50 °F, it is charged in a low current to protect the battery cells. In this case, charging time may stretch to up to 32 hours.

If you use the system at a low temperature, refer to the following:

- The battery capacity may be reduced depending on the chemical characteristics of the battery and the system may not be turned on after it freezes or it is turned off.
- If the system freezes or if it is not turned on, connect the adapter to the system and charge the battery fully before use.
- If there is any error in the indication of the battery capacity, charge and discharge the battery two or three times at room temperature to return to the normal operation.

Operation Status Lamps

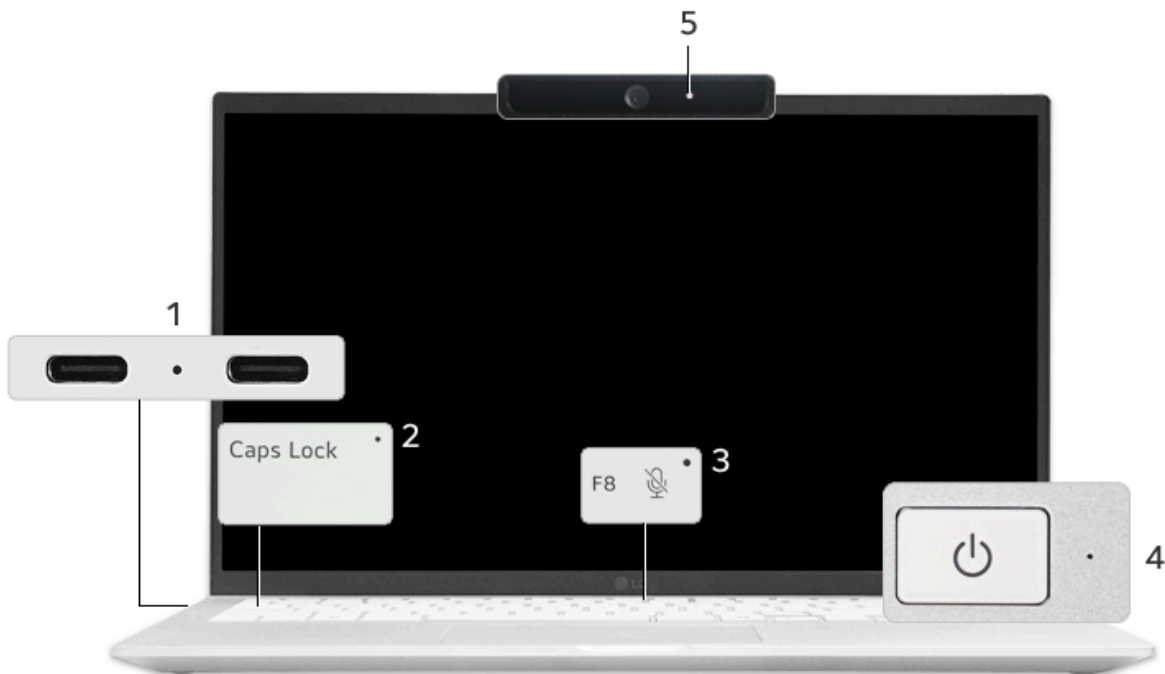

1. Adapter power Lamp

- On: When the adapter is connected and charging is complete
- Blinking: When the adapter is connected and is charging
- Off: When the adapter is not connected

If you try to turn on the system that has entered the Hibernate mode or been turned off after a low-battery alarm, the system will not be turned on but the lamp will blink three times. If this is the case, connect the adapter and charge the battery sufficiently before using it.

2. Caps Lock Lamp

- On: When the Caps Lock is activated
- Off: When the Caps Lock is deactivated

3. Microphone Operation Status Lamp

- On: When the microphone is deactivated
- Off: When the microphone is activated

4. Power Lamp

- On: When the system is on and running by the adapter or battery
- Off: When the system is turned off or in Hibernate mode
- Blinking: When the system is in the standby mode

5. Webcam Operation Status Lamp

- On: When the webcam is operating
- Off: When the webcam is not operating

Keyboard & Keyboard Backlight

The keyboard allows the user to input data or give commands.

The keyboard may differ in appearance and color depending on your country.

Copilot key feature availability varies by market, see aka.ms/KeySupport



Caution:

- Spilling a watery substance like coffee or juice on the keyboard may cause a fault, malfunction, or electric shock.
- Some of the keys may not work properly when you use several keys at the same time while playing a PC game.
- Please change the key combination settings according to the combinations necessary for the game play or use an external keyboard dedicated for gameplay.

Using Hot Keys

Hot Keys are shortcut keys that can run some functions and software of the PC, and using them allows you to use the PC more easily.

Fn + Esc	Locks/Unlocks the Fn key.
Fn + F1	Run My gram
Fn + F2	Adjusts screen brightness (brightness decreases in 11 levels).
Fn + F3	Adjusts screen brightness (brightness increases in 11 levels).
Fn + F4	Switches to using the Touchpad Mode

- Each time you press the [Fn] + [F4] keys, the mode switches between Touchpad Off (touchpad disabled) and Touchpad On (touchpad enabled).
- To set Touchpad Auto (disables automatic use of touchpad when inserting an external USB mouse), select the Start button  > [Settings] > [Bluetooth & devices] > [Touchpad] and uncheck [Leave touchpad on when a mouse is connected] in [Touchpad].

Each time you press the [Fn] + [F4] keys, the mode switches between Touchpad Off and Touchpad Auto.

Since it takes about 1 to 2 seconds to initialize after switching to the touchpad function, we recommend you to use the device after initialization is completed.

Fn + F5	Switches to the monitor (projector).
Fn + F6	Switch to the Keyboard Backlight Mode
Fn + F7	Switches to Cooling Mode <ul style="list-style-type: none"> • Each time you press the [Fn] + [F7] keys, the mode switches between High Performance Mode, Low Noise Mode and Normal Mode.
Fn + F8	Switches to the Microphone Mode <ul style="list-style-type: none"> • Each time you press the [Fn] + [F8] keys, the mode switches between Mic Mute (microphone mute) and Mic Unmute (microphone unmute).
Fn + F9	Switches to the Webcam Mode <ul style="list-style-type: none"> • Each time you press the [Fn] + [F9] keys, the mode switches between Camera Off (webcam unavailable) and Camera On (webcam available).
Fn + F10	Mute
Fn + F11	Adjust the volume (lower)
Fn + F12	Adjust the volume (louder)
Fn + A	Run Capture Tool
Fn + S	Switches to the Sleep Mode <ul style="list-style-type: none"> • Runs in the mode set in Windows. (Example: Sleep Mode, Hibernate Mode)
Fn + L	Switches to PC Cleaning Mode
Fn + Space bar	Run gram chat On-Device <ul style="list-style-type: none"> • It is not run in a model whose system memory is configured below 16 GB.

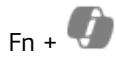

Works as the [Pop-up Window] key.



Works as the [Home] key.



Works as the [End] key.



Works as the [Page Up] key.



Works as the [Page Down] key.



Tip:

While pressing and holding the [Fn] key, the shortcut guide is displayed on the screen. You can press each key and use the function immediately.

Keyboard Backlight

You can use the Keyboard Backlight function to use the product in a dark environment.

- Press the [Fn] + [F6] keys on the keyboard and use Keyboard Backlight.

The status changes in the following order: KBD Backlight Off, KBD Backlight Low, and KBD Backlight High.

[Setting]

You can set the Keyboard Backlight and off time on My gram.

1. Select the Start button [] > [All] and run [My gram].
2. Select [PC Maintenance] > [Keyboard] to set the keyboard backlight.

Adjusting Screen Brightness and Volume

LG PC allows you to use the hot keys to easily adjust the screen brightness and volume.



Tip:

According to the model type, a button for volume control (mute, volume up/down, Dolby, etc.) may be available.

Function	Hot Keys	Description
Screen Brightness	[Fn] + [F2], [F3]	<p>Press the [Fn] + [F2] keys to darken the screen and the [Fn] + [F3] keys to brighten the screen.</p> <p>The screen brightness adjustment bar in [Quick Settings] on the right side of the taskbar allows you to adjust the system brightness.</p>

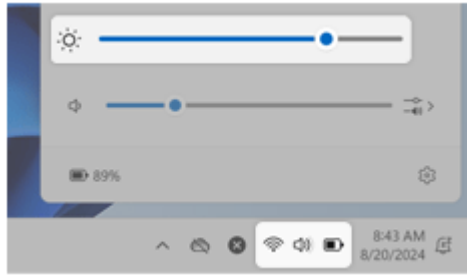

Volume [Fn] + [F11], [F12]

Press the [Fn] + [F11] to lower the volume and [Fn] + [F12] to increase the volume.

The volume adjustment bar in [Quick Settings] on the right side of the taskbar allows you to adjust the volume.

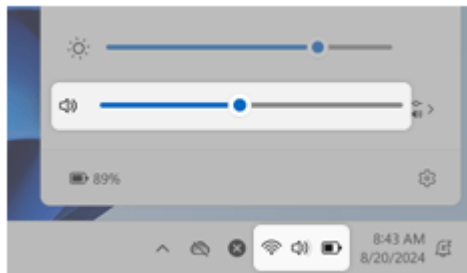

Mute [Fn] + [F10]

Whenever you press [Fn] + [F10], it operates as mute/unmute.

If you select the [] icon in [Quick Settings] on the right side of the taskbar, you can enable or disable the mute function.

Using the Touchpad

The built-in touchpad provides the same functionality as an external mouse. You can use the touchpad and USB mouse simultaneously.

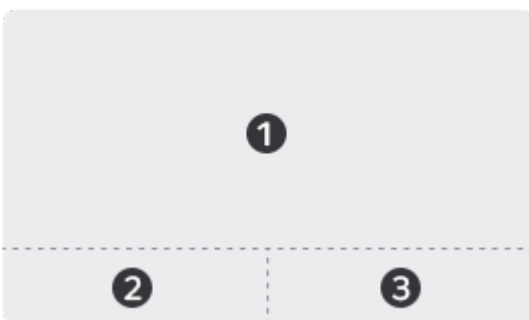

1. Touchpad

- Moves the cursor.

2. Left button

- Use to select or execute programs.

3. Right button

- Functions as the right button of a mouse in most cases. However, the usage may differ depending on programs.



Tip:

The scroll function is provided as a gesture. Please refer to the Touchpad Gesture section of this document.

Precautions for Using the Touchpad

- If you are using a touchpad, use the area marked with a red line shown below. Touching an edge or border of the touchpad may not work. (The functioning touch area may differ depending on the product.)



Moving the Cursor (Pointer) on the Screen

Place a finger on the touchpad and glide the finger.



Click (Select)

Press and release the left button swiftly with a finger. (Or tap the touchpad once.)

Do this, for example, to select a menu or icon and to place the cursor to type on a word processor file.

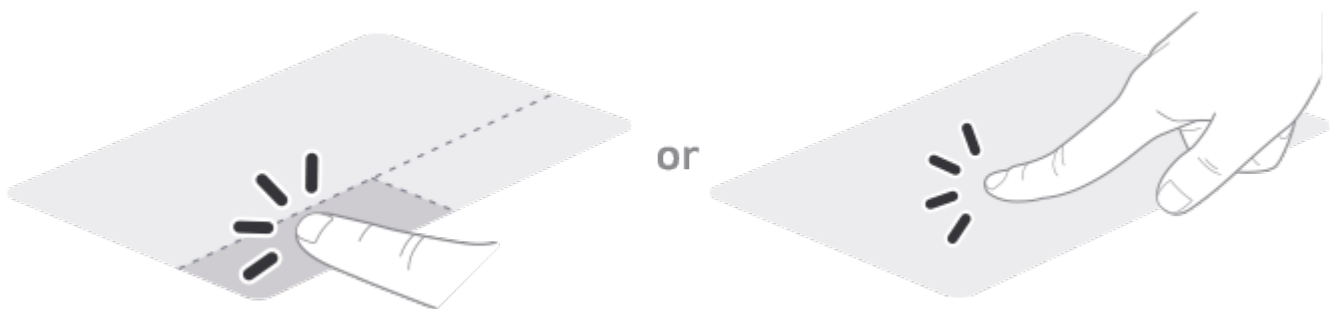

Double-click (Execute)

Press the left button twice consecutively and release the button. (Or tap the touchpad twice.)

Do this, for example, to run a program after selecting its execution file (or icon).

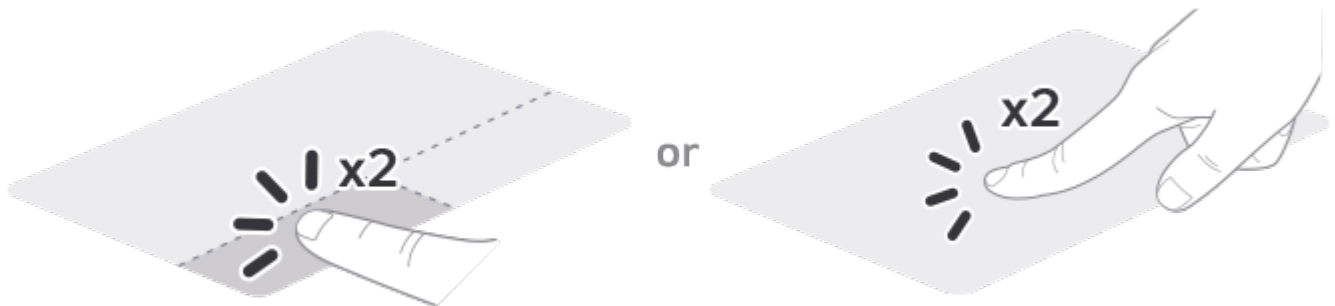

Caution:

Notes on Using the Touchpad

- Do not use a sharp object such as a pen on the pad nor peel the cover. It may cause an impairment.
- Do not place more than one finger, and do not use while wearing a glove or when the hand is wet. The Touchpad will not work properly. Oil or dirt at the fingertip can also cause an impairment.
- The touchpad is sensitive. Do not impose excessive force or maintain an uncomfortable position. Otherwise, it may result in a finger or wrist injury.

Right button

Press and release the right button swiftly.

Functions as the right button of a mouse, but the usage may differ depending on programs.

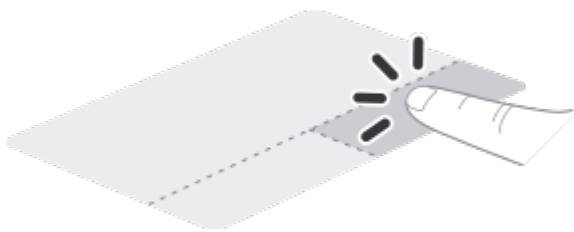

Drag & Drop

To drag, click and hold an icon, and move it to another location.

To drop, release the dragged icon in the location you want.

To move a file icon to another folder or to Recycle Bin, place the cursor (or the pointer) on the icon, press and hold the left button, and glide another finger on the touchpad until the icon reaches the aimed location. After reaching the destination, release the left button.

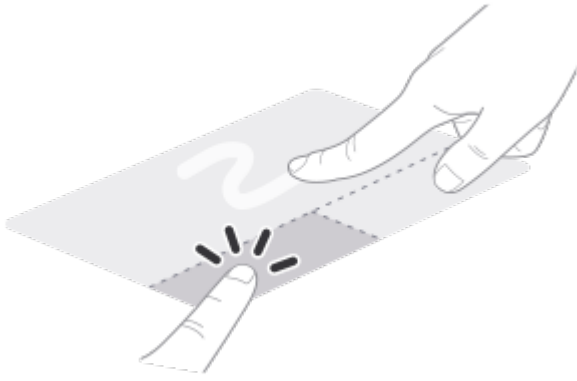

1. Drag

- Glide one finger on the pad with another finger pressing and holding the left button.

2. Drop

- Release the left button to drop it into the Recycle Bin. (By using this, you can drop a file into the Recycle Bin at will.)

ClickLock

When activated, this feature allows you to drag/scroll without pressing and holding the left button.

1. Select the Start button [] > [Settings].



Tip:

Press the [] key or [Ctrl] + [Esc] on the keyboard to display the Start screen.

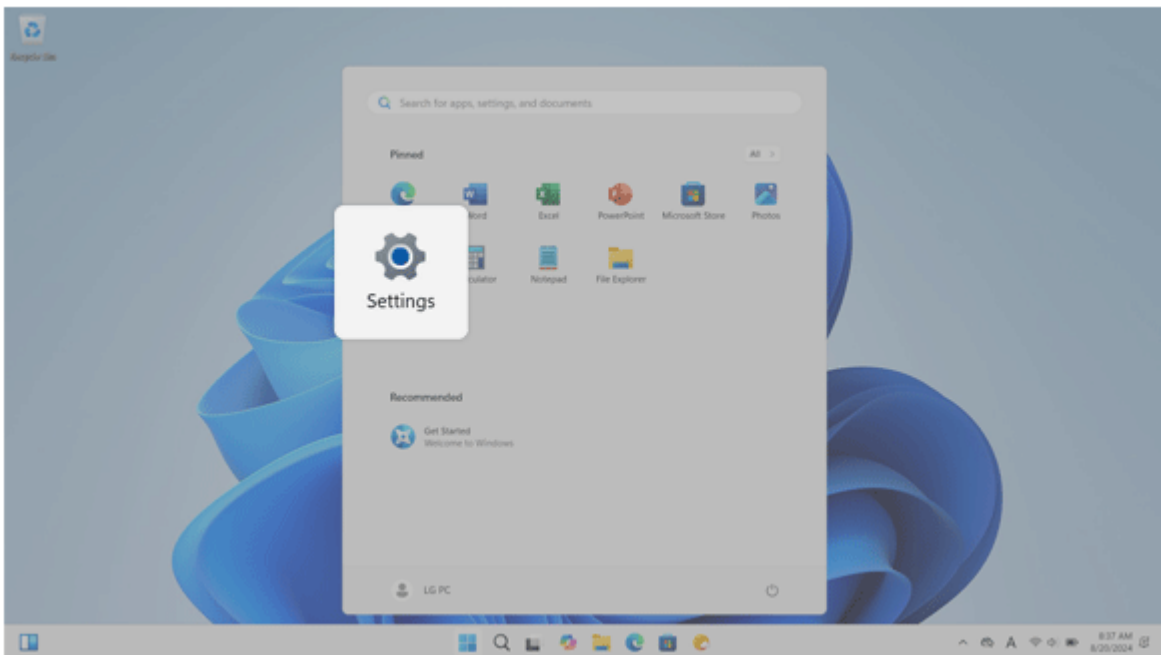

2. Select [Bluetooth & devices] > [Mouse] > [Additional mouse settings].
3. Check [Turn on ClickLock] and select [Settings].

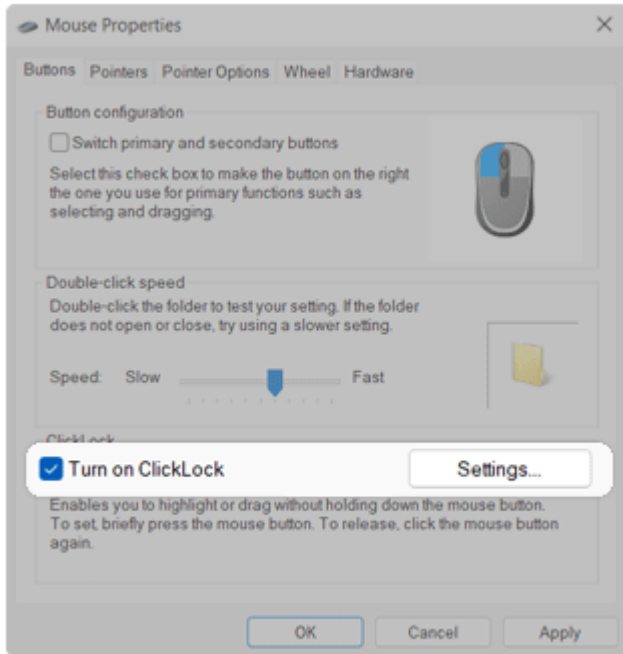

4. Set the duration of ClickLock operation.

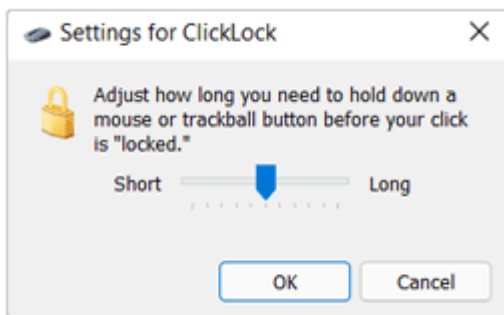

5. Press the left button of the touchpad and release it to change the button into the pressed state.

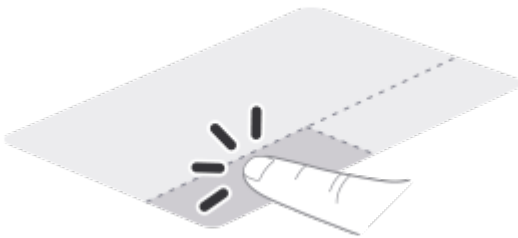

6. Move on the touchpad to use the drag/scroll feature.



7. Press the left mouse button to turn off the ClickLock.

Touchpad Gesture

The touchpad gesture feature allows you to use Windows programs more easily by utilizing multi-touch functions.

Windows 11 Touchpad Gestures allow you to use the PC more easily.

The touchpad gesture feature may not be supported in some models.

- Place two fingers on the touchpad and move up/down/left/right to scroll the screen.
(It operates only on an app or screen which scrolling is available.)

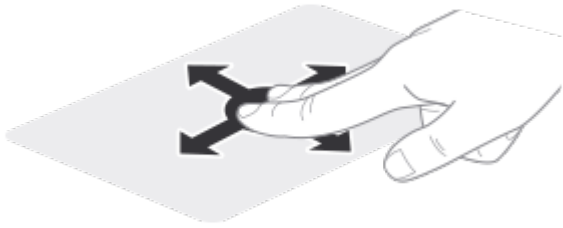

- Place two fingers on the touchpad and widen or narrow them to zoom out or in.

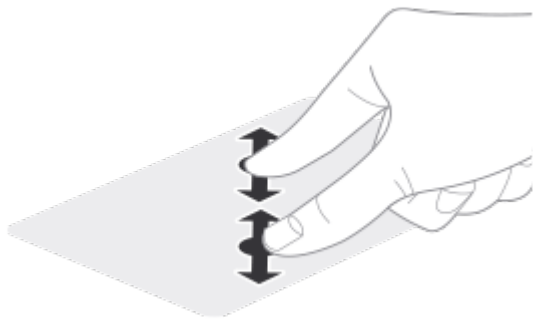

Setting Touchpad

You can change the touchpad features or enable/disable the gesture feature.

1. Select the Start button [] > [Settings].



Tip:

Press the [] key or [Ctrl] + [Esc] on the keyboard to display the Start screen.

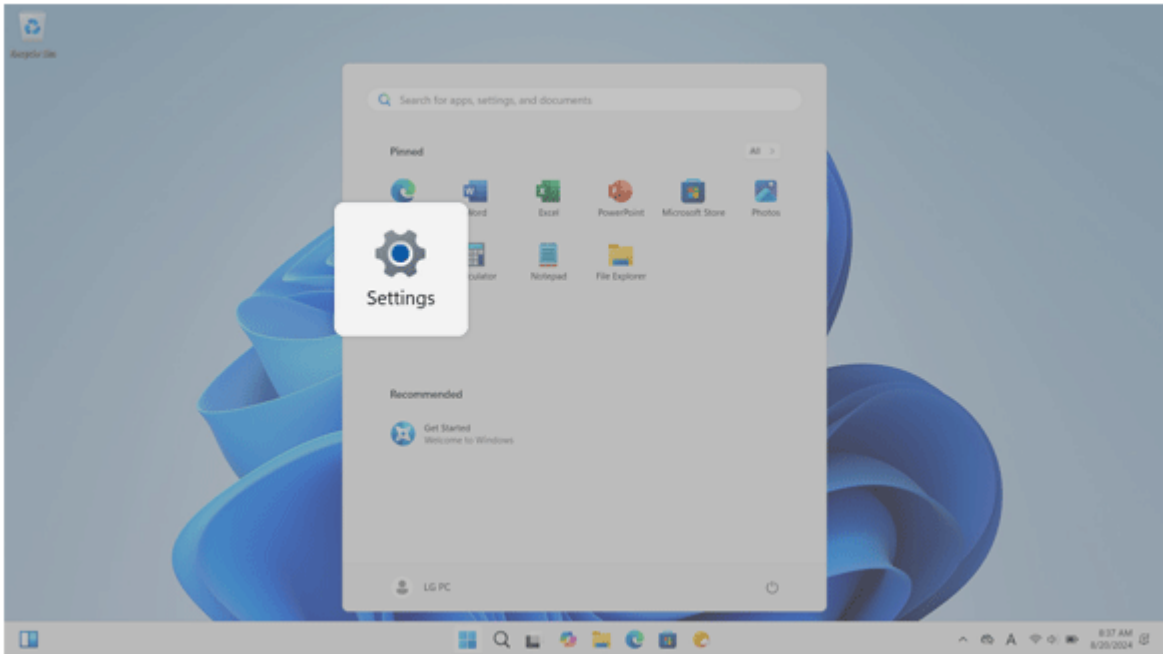

2. Select the [Bluetooth & devices] > [Touchpad].
3. Change the settings as needed on the [Touchpad] item.

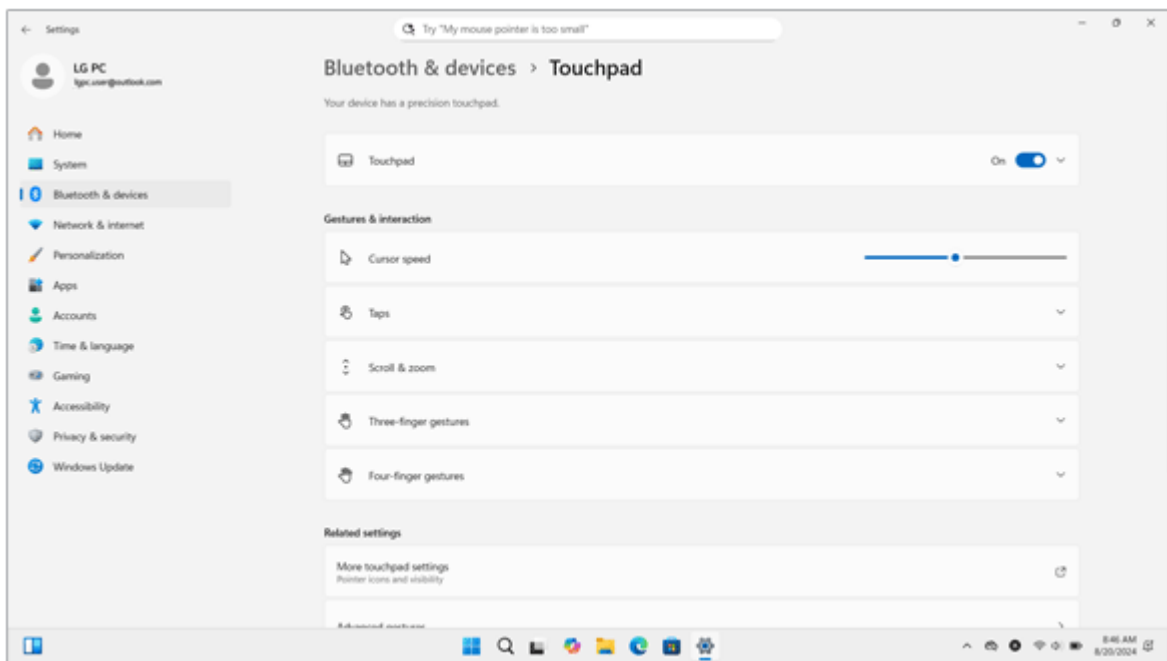

Using Touch Screen

Use the touch screen for a faster and more convenient use of the computer. All gestures provided by Windows 11 can be used.

For more details about the Windows 11 gestures, refer to the Windows help.



Option:

This applies only to models equipped with a touch screen.

Basic Usage

1. **Touching Once:** Touch the screen once to produce the same effect as clicking the left mouse button.



2. **Touching Twice:** Touch the screen twice to produce the same effect as a double-click.

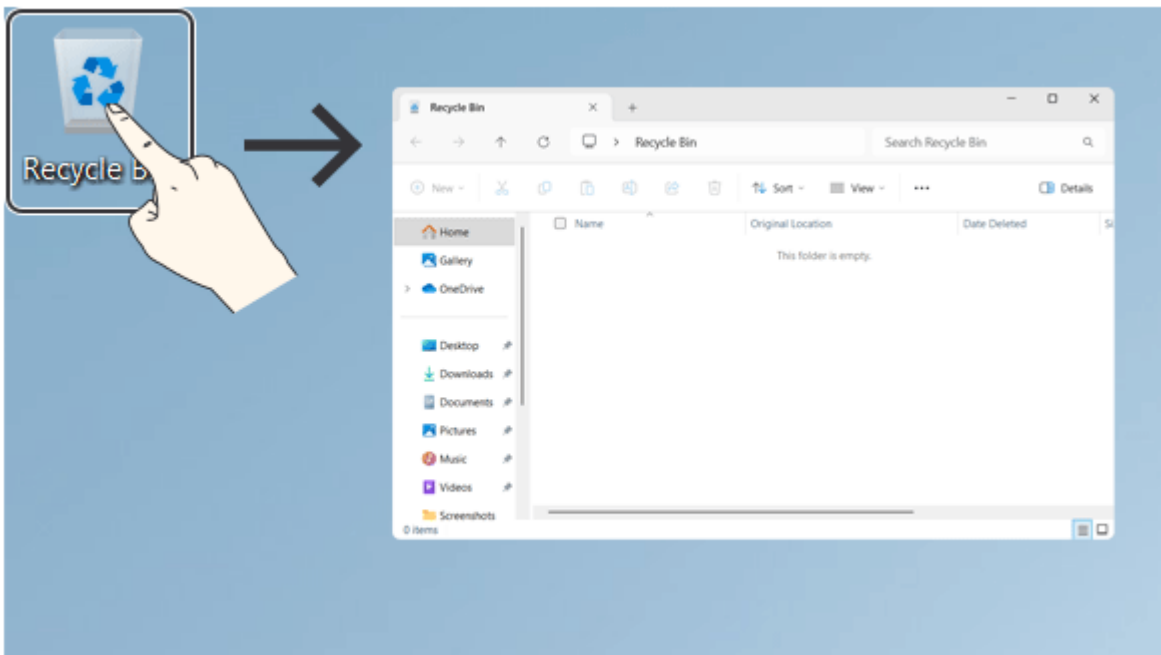

3. **Drag:** After touching the start point, finger movement can be used instead of the mouse.

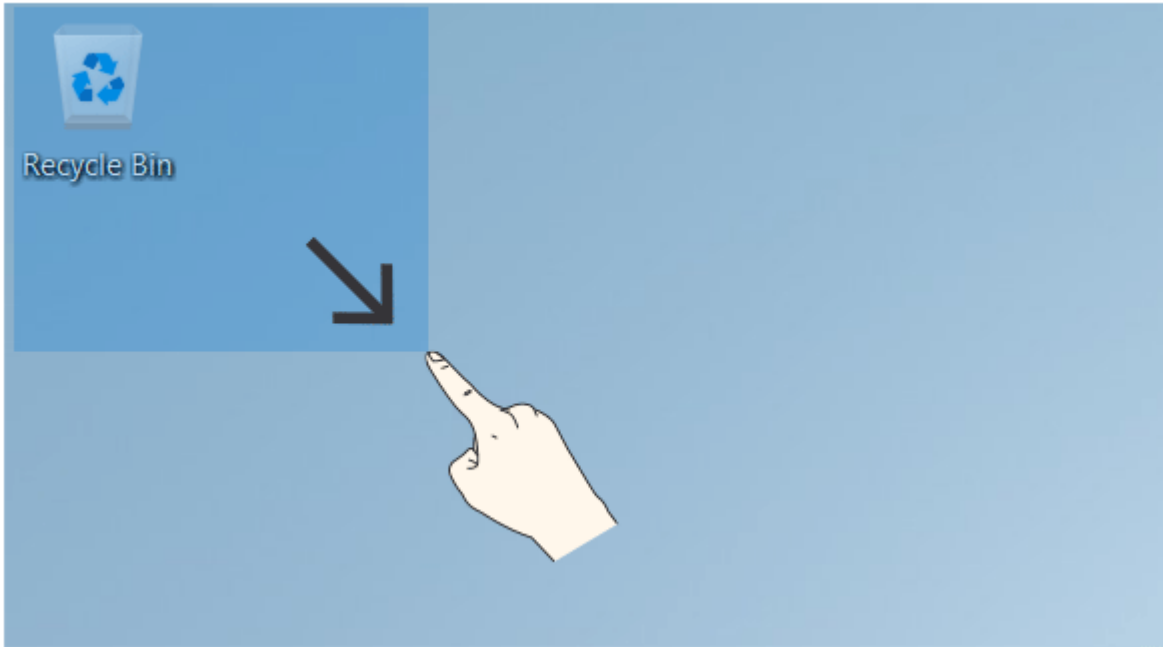

4. **Touching Longer:** Touch the screen for a longer time to use as right mouse button.



Using the Touch Keyboard

1. Right-click on the taskbar, select [Taskbar Settings], and then set [Touch Keyboard] to [Always].
2. Press the icon  on the bottom right of the taskbar to display the [Keyboard] screen.



Connecting to External Display

Connect the external display device through HDMI or the USB-C® port of the PC to output a PC screen to an external display.

In some models, the Dolby Audio function may not work when connecting to an external display.



Tip:

- Connect to the PC while the power of the external display device is turned off.
- If the external display screen does not appear after connecting to the PC, check Input Mode of the external display device.
- By connecting a display that supports USB-C® Alternate Mode, you can use the USB-C® port to output a screen to an external display.

Alternate Mode is a mode that uses display outputs such as DP (Display Port) and HDMI through the USB-C® port.

- The USB-C® port supports the interface with the DP (Display Port) specifications.



Caution:

- Use the cable/adaptor that fits the USB-C® specifications and supports Alternate Mode.
- The USB-C® cable/adaptor for non-LG products may not be connected or cause a problem.

1. Connect the PC and external display with a cable that fits the external display device.

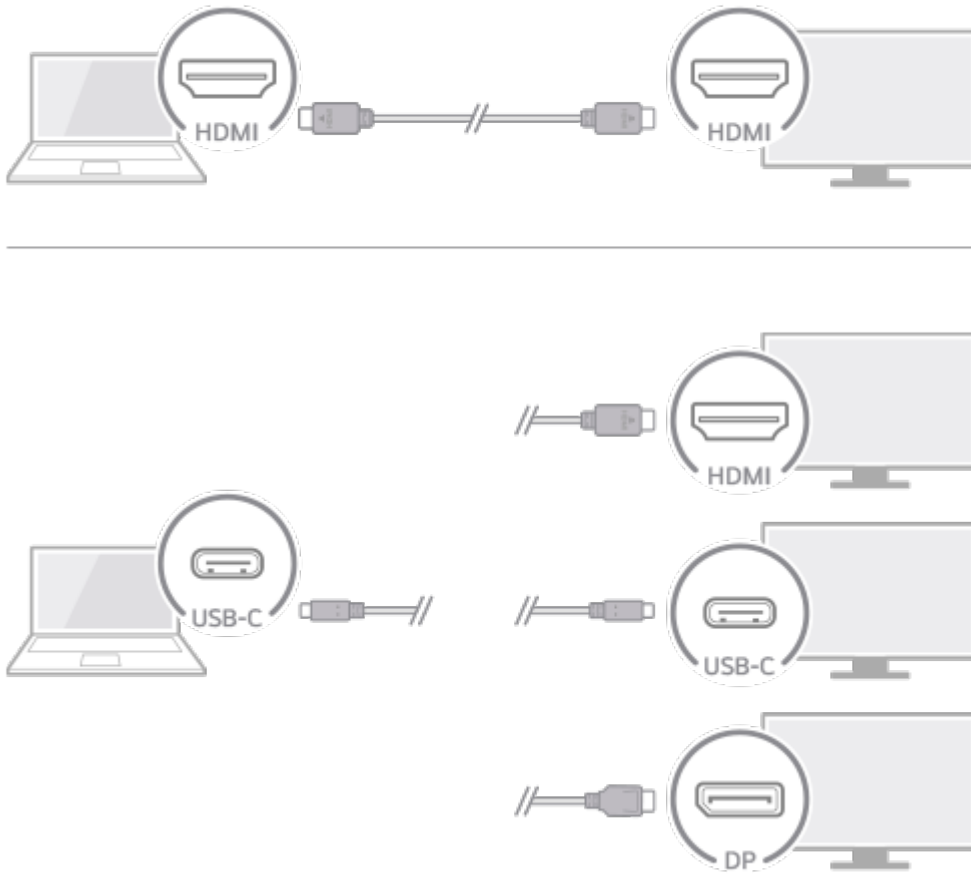

2. Turn on the power of the external display device.

3. Press the [Fn] + [F5] (or [Windows] + [P]) keys on the keyboard to change Display Mode.

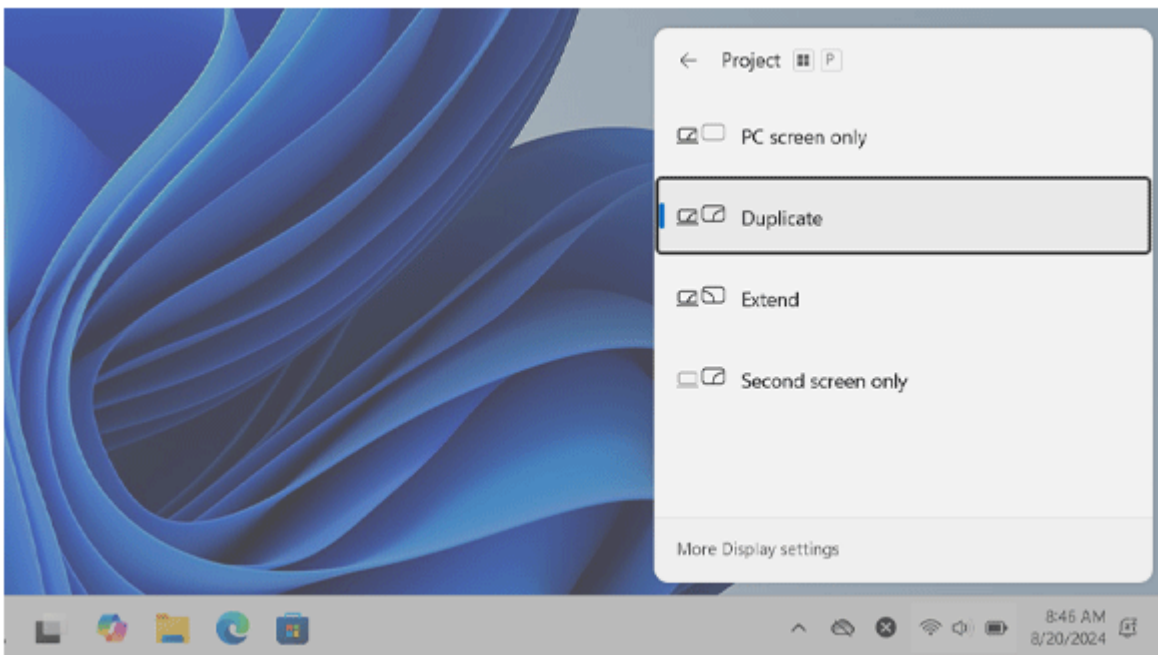

 **Caution:**

If you do not set Speaker as the default value after separating the external display connection cable, the system may not produce any sound. (If a program was running already, you must exit and restart the program to produce sound.)

Connecting to Wireless Display

The wireless display feature connects the PC screen and sound to a display (TV, projector, etc.).

 **Option:**

- To use the wireless display feature, the display device must support this feature.
- To connect to the display device that does not support wireless display, you must separately purchase a wireless display connection device.
- Once the wireless display connection is established, no additional procedures and searching are necessary the next time you try to connect.

Connecting to Wireless Display

1. Select the Start button [] > [Settings].

 **Tip:**

Press the [] key or [Ctrl] + [Esc] on the keyboard to display the Start screen.

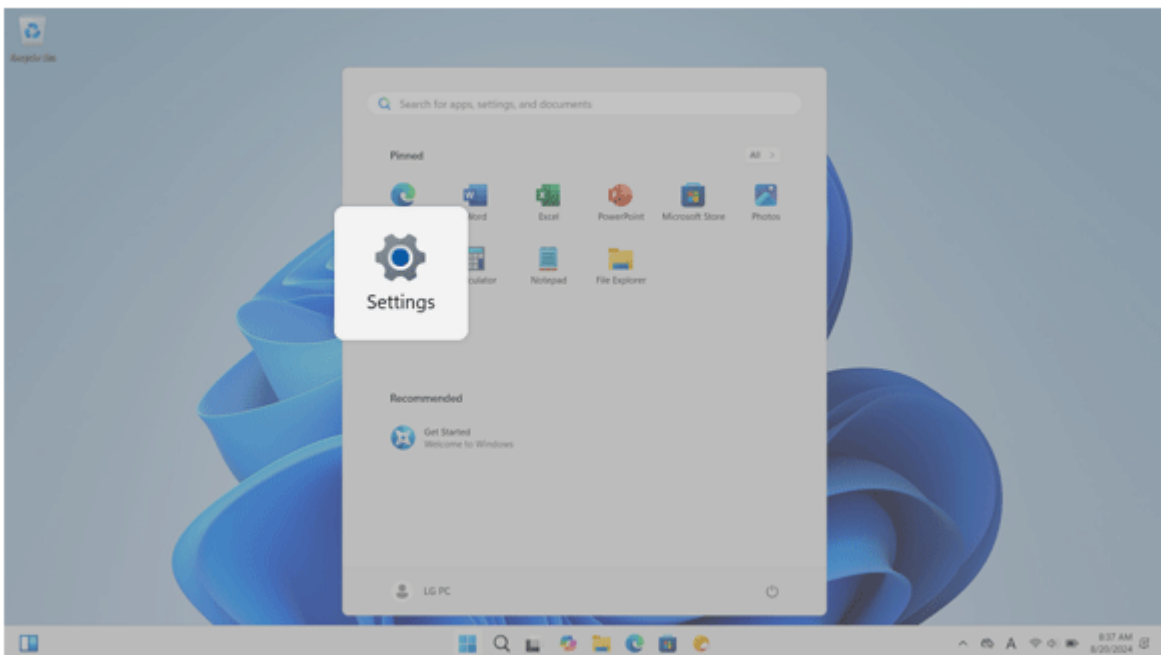

2. Select [Connect] under the [System] > [Display] > [Multiple displays] > [Connect to a wireless display] menu.

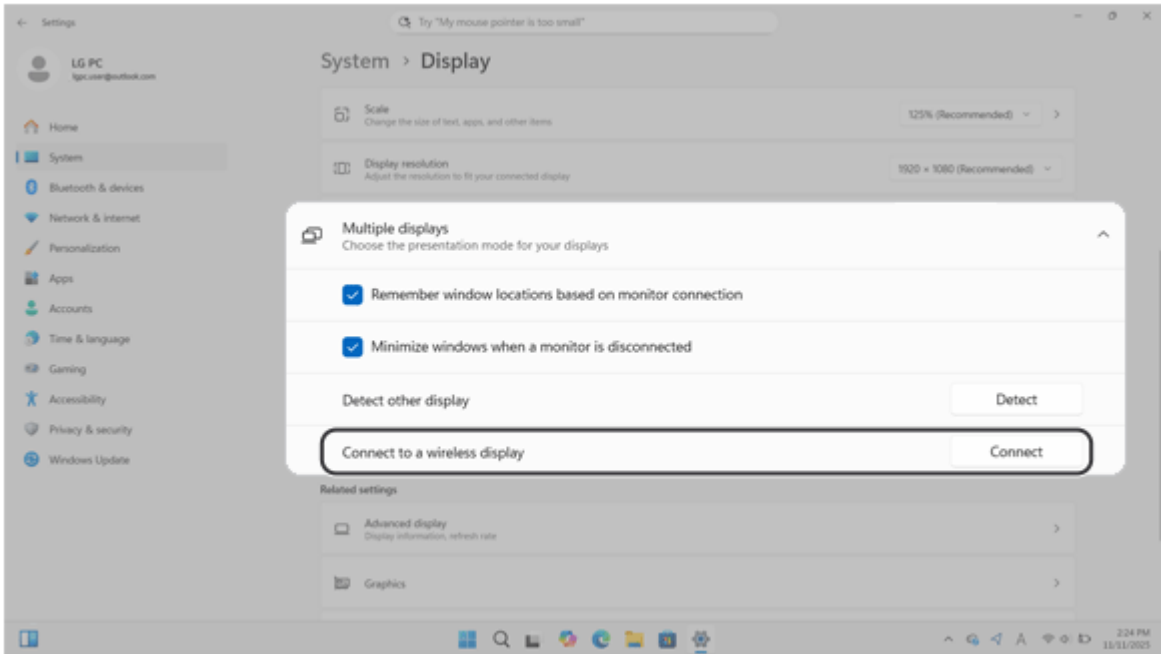

3. If the device search screen appears, it will search for nearby wireless display devices.

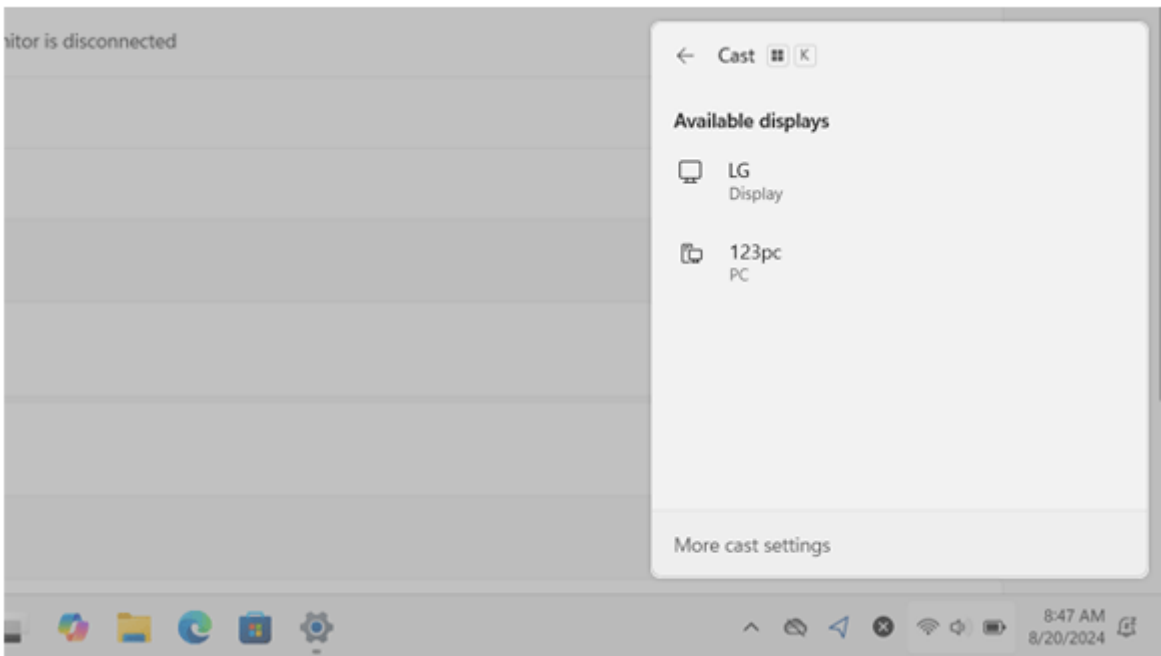

4. Select an available device and connect the device.

5. Once the wireless display device is connected, it outputs the PC screen and its sound.

Connecting an External USB-C® Device

The USB-C® port mounted on this product supports USB 3.2 Gen 2x1 standards.

You can use the USB-C® port to connect the USB device.

Connecting a USB Device

If a USB device is connected to a USB-C® port, the port works as an ordinary USB port.



Tip:

To use a conventional USB device, a separate conversion adapter should be used.
(Conversion adapters may be purchased separately.)

Using USB-C® Charging Function

You can connect the USB-C® device to charge a notebook PC battery or an external device, and the operation mode is automatically selected depending the charge settings of the connected device.

- To charge a notebook PC battery, the external device (USB PD Charger, notebook PC, etc.) should support USB Power Delivery 10 W (5 V / 2 A) or higher profile.
- The external devices that use the USB-C® port support 10 W (5 V / 2 A) and 15 W (5 V / 3 A).
- A USB device compatible with USB PD (Power Delivery) supports charging at 15 W (5 V / 3 A), whereas a regular USB device supports charging at 10 W (5 V / 2 A). If you use two USB-C® ports simultaneously, each port supports charging at 7.5 W (5 V / 1.5 A).
- USB PD batteries cannot be charged using the USB-C® port of the notebook PC.
- Always-On Charging is supported only with USB-C® ports, but not with the regular USB ports.
- If you connect an adapter with a lower output than the rated adapter, it may take more time to charge the notebook PC.
 1. When the connected device is set to Automatic (charging the notebook PC or a connected device. Charging the notebook PC by using the mobile phone is not supported.)



2. When the connected device is set to Source (the notebook PC is charged.)



3. When the connected device is set to Sink (the connected device is charged.)



Tip:

The charging status of the external device being charged is not displayed on the notebook PC.

If you connected a smartphone, you should select "Charge mobile phone" on the smartphone screen to charge the phone battery.



Caution:

If the power consumption of the notebook PC is larger than the power supply from the external device, the battery may be consumed gradually.

Bluetooth

Bluetooth allows the user to access wirelessly various devices such as camera, cell phone, headset, printer, and GPS receiver that support Bluetooth. It can also establish a network and exchange data with other Bluetooth-enabled PC or smartphone.

For details on connecting a Bluetooth device, refer to the user manual provided with the Bluetooth device.



Option:

The Bluetooth device is optional, and it may not be available in some models.

1. Select the Start button [] > [Settings].



Tip:

Press the [] key or [Ctrl] + [Esc] on the keyboard to display the Start screen.

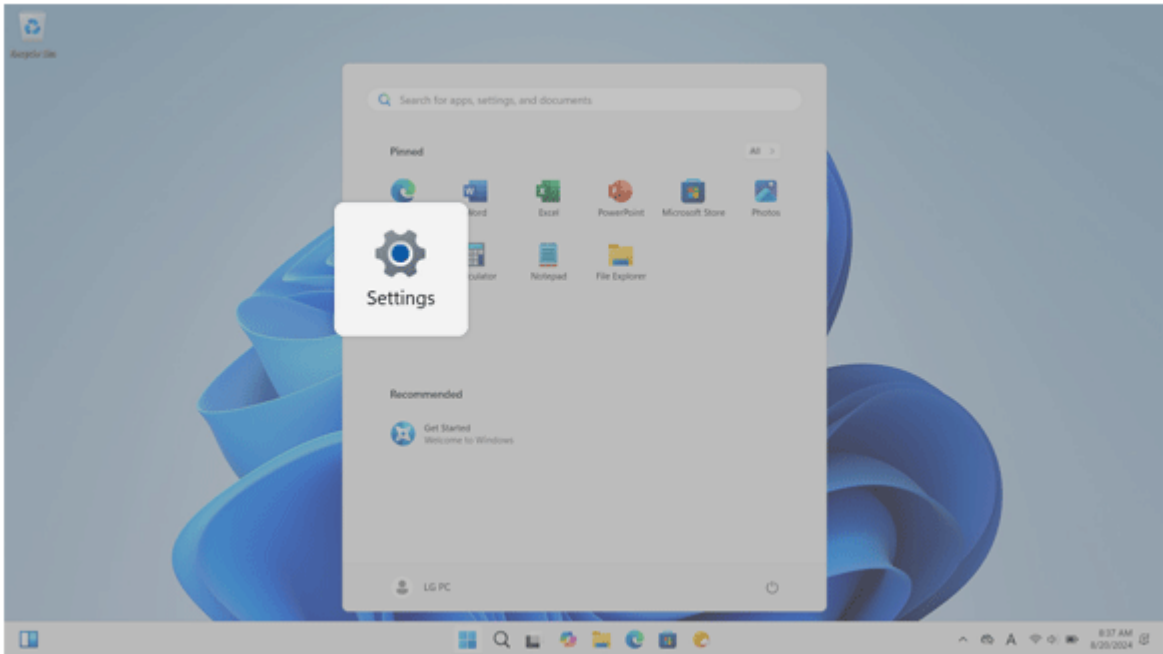

2. Select [Bluetooth & devices] > [Add device].

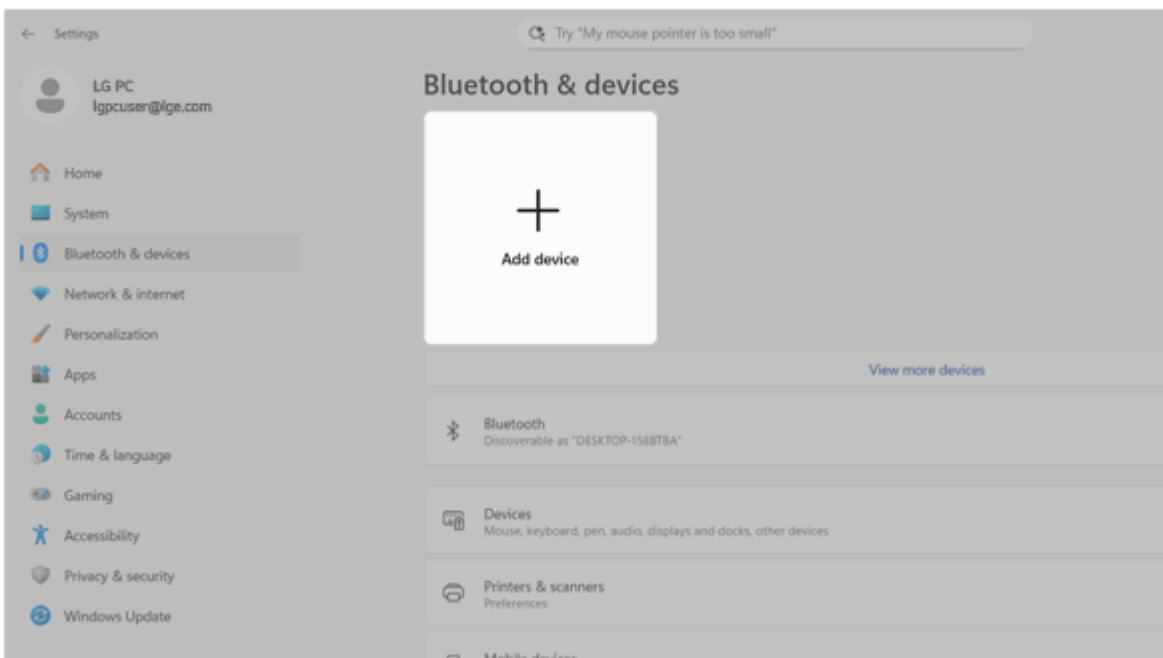

3. Select the Bluetooth to search for Bluetooth devices automatically.

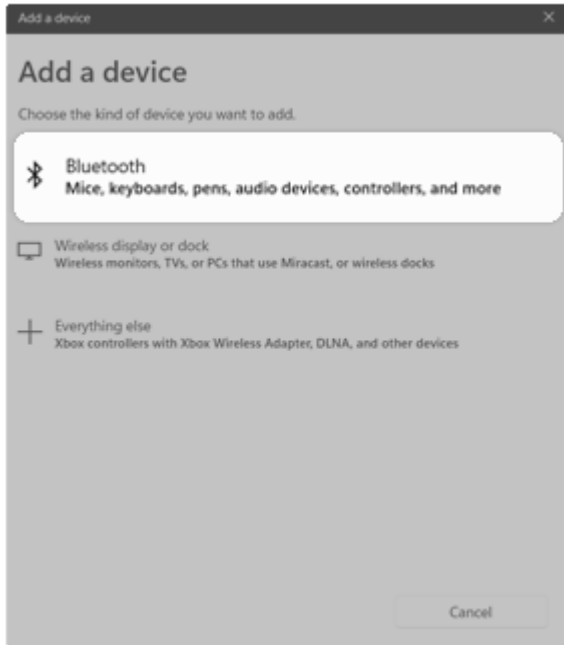

4. After selecting the device you want to connect, complete the Bluetooth connection as guided.

Wired LAN

LAN is the network environment that users can connect to by using a cable to connect to their internet providers or the company's network.

Using Wired LAN

LAN is installed with an automatic IP (DHCP) as default value.

Please refer to the following instructions for details on setting up an automatic IP (DHCP) or manual IP.

1. Connect the LAN adapter to the USB-C® port on the PC.



Tip:

The recommended network cable for the optimal network environment is CAT5 or higher.

The network (LAN) cable may be connected when the LAN adapter is used.



2. Connect the wired LAN cable to the LAN port.



3. Select the Start button [] > [Settings].



Tip:

Press the [] key or [Ctrl] + [Esc] on the keyboard to display the Start screen.

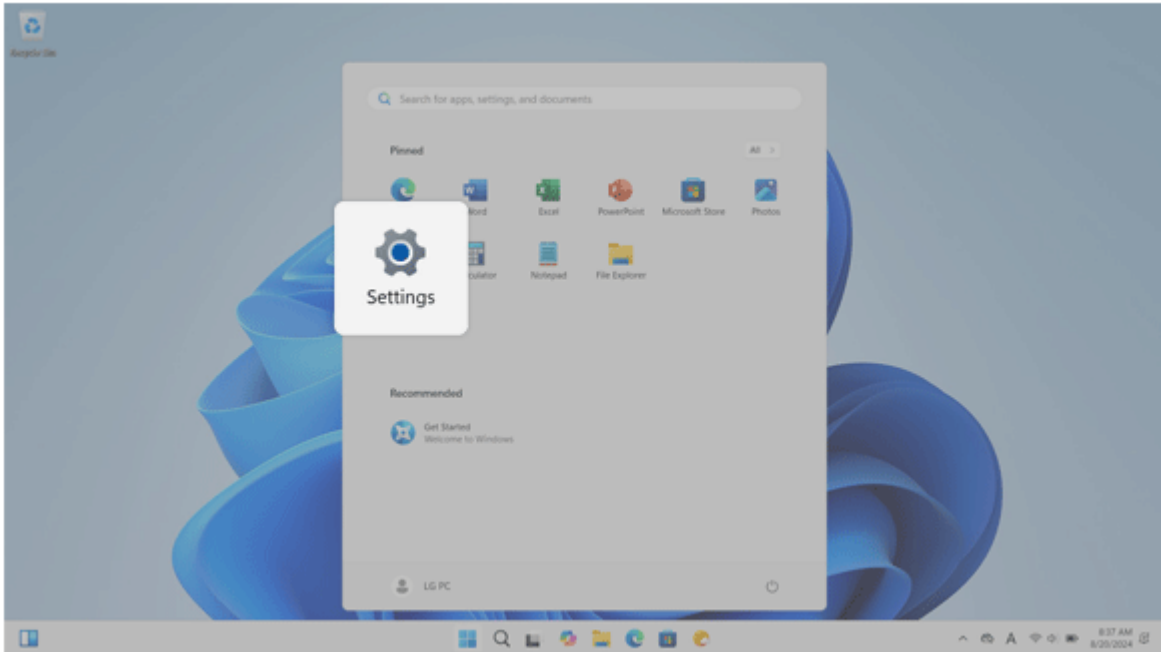

4. Select [Edit] in [Network & Internet] > [Ethernet] > [IP assignment].

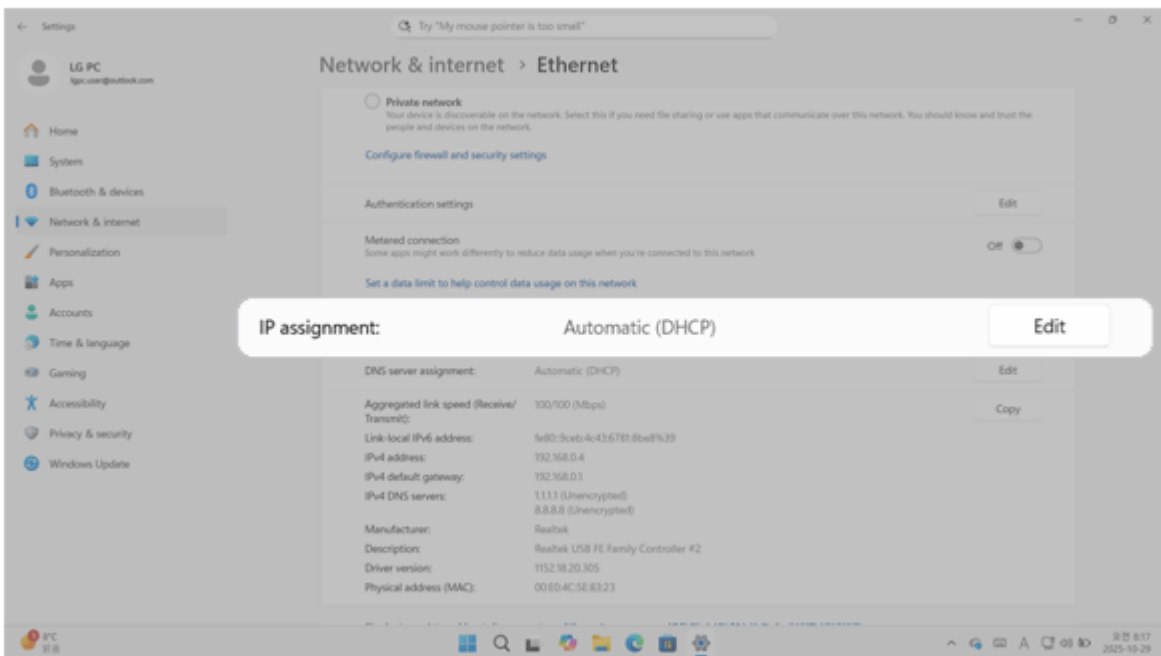

5. To use an automatic IP (DHCP), select [Automatic]. If you wish to use a static IP, set [Manual] > [IPv4] to [On] and enter the necessary item.

Contact the network service provider or administrator to use a static IP.



6. Select [Save] to complete the network setup.
7. Click the Web Browser icon to check whether the internet is operating normally.

Wireless LAN

The wireless network (Wireless LAN) is the network environment that connects a PC with the internet provider or company network through an Access Point (wireless or regular router).

Using the Wireless LAN

If an Access Point (wired or wireless router) is in the vicinity of the PC, the wireless LAN can easily be accessed.

1. Select [Quick Settings] on the right side of the taskbar.



Tip:

The displayed icons may differ from the figures herein.

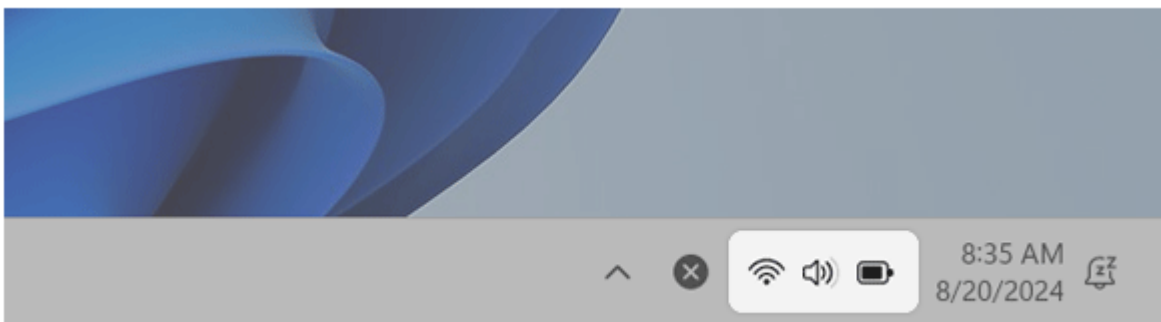

2. Select Manage Wi-Fi Connections [] to search for near Access Point.

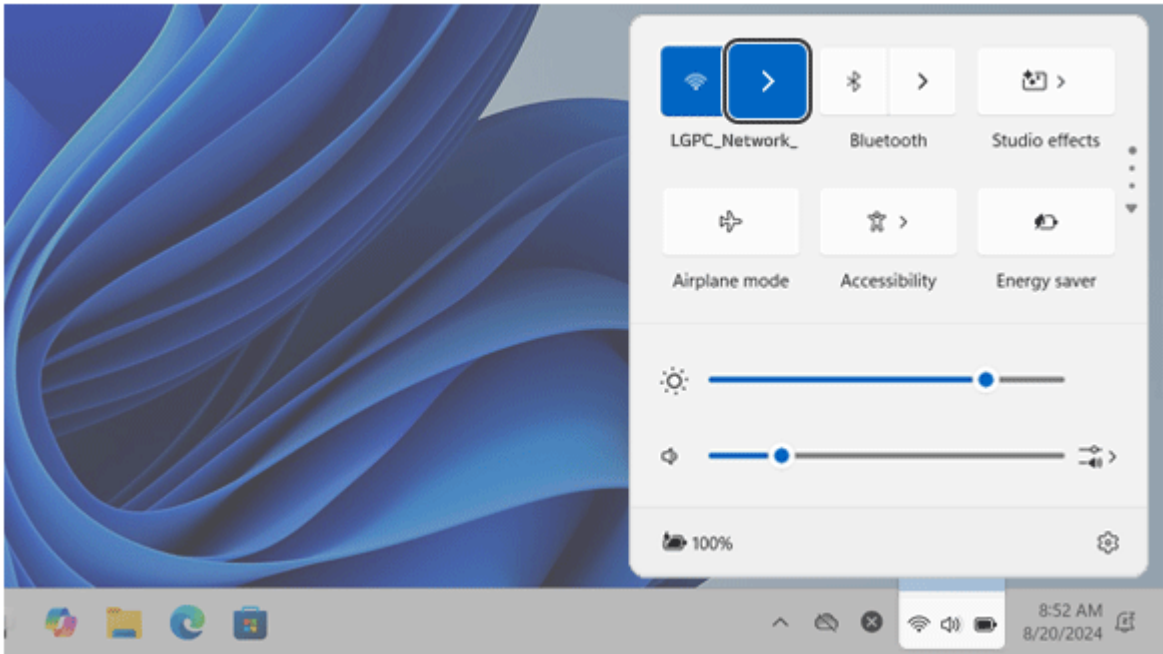

Tip:

When Wi-Fi is turned off, set [Wi-Fi] to On.

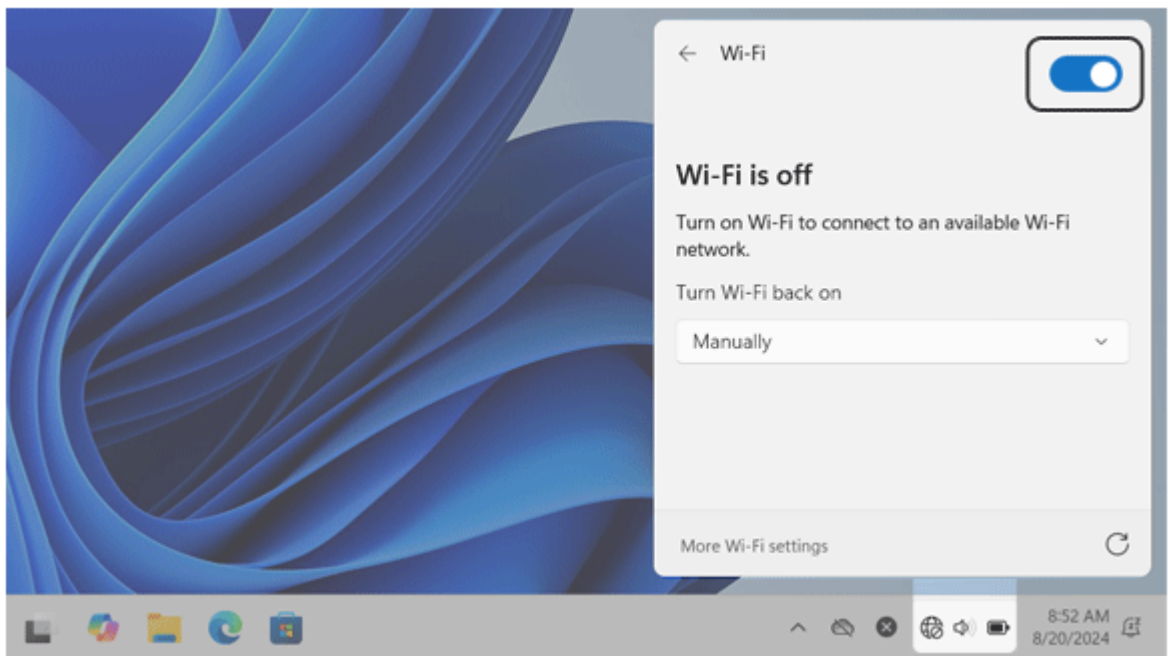

3. Select the Access Point you want to connect to and press [Connect].

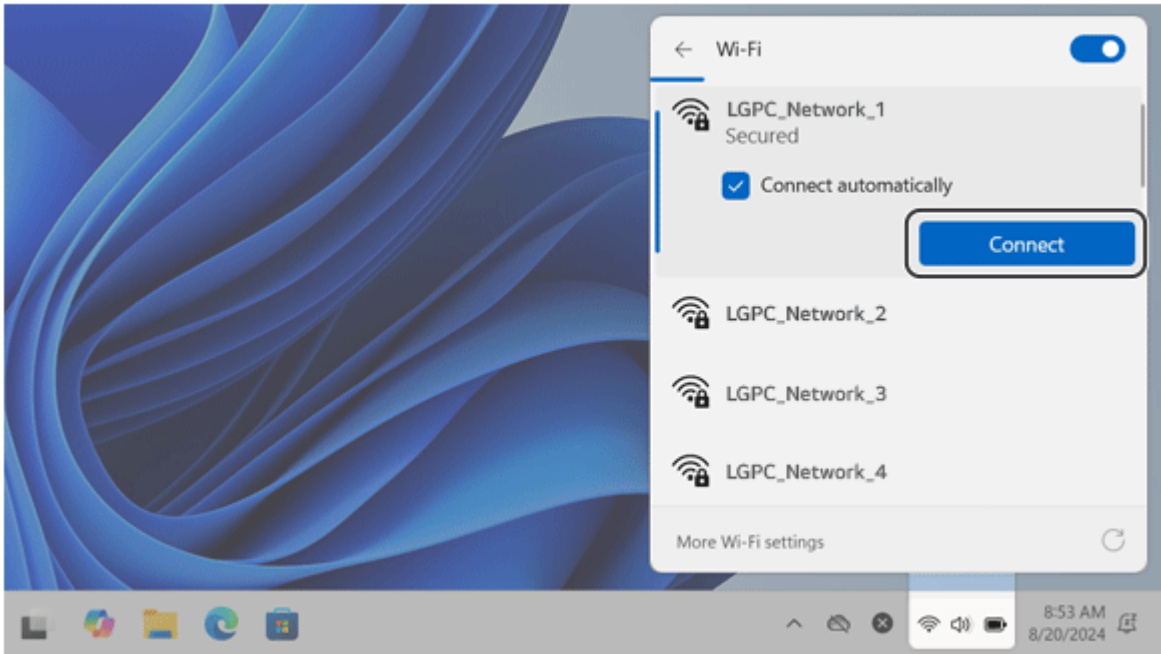

4. If a connection is established, [Connected] appears below the Access Point name.
5. Click the Web Browser icon to check whether the internet is operating normally.



Tip:

When searching for a wireless LAN, multiple Access Points may be discovered depending on the location of use. In case no accessible wireless LAN is near the PC, no Access Point might be found. A password-protected Access Point cannot be accessed without the correct password.

Using the Airplane mode

You can use the Airplane mode to turn off wireless functions such as wireless network and Bluetooth.

- Select [Airplane mode] from [Quick Settings] on the right side of the taskbar to turn on/off the Airplane mode.

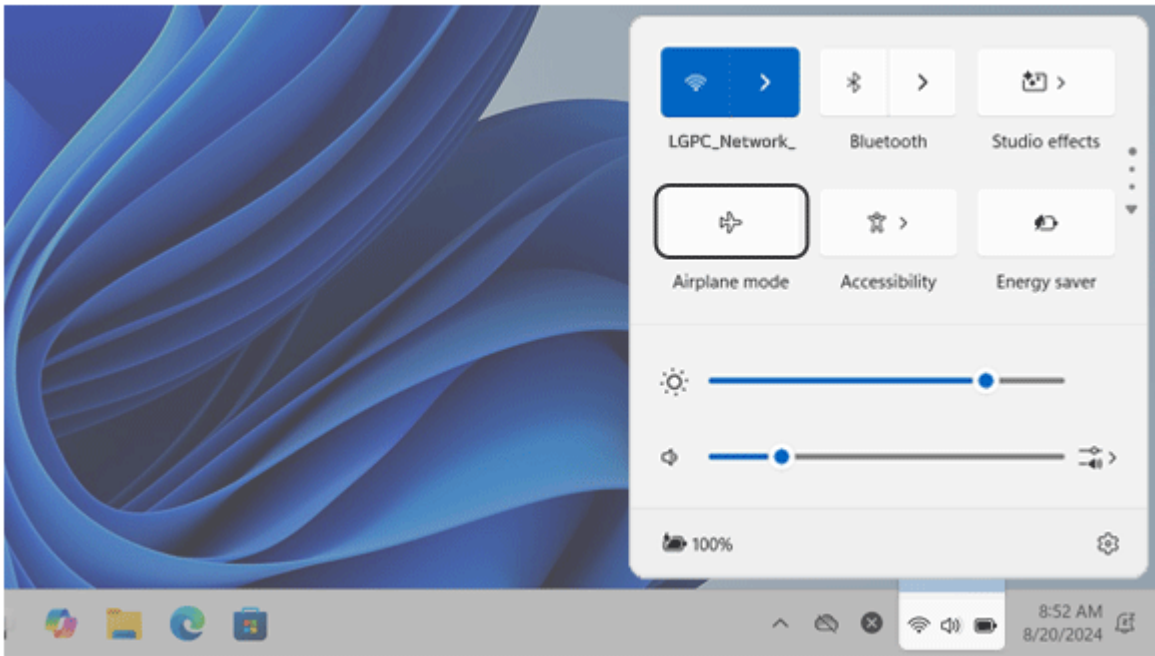

 Tip:

If you turn on the wireless network or Bluetooth while the Airplane mode is on, the wireless network or Bluetooth settings are maintained. If you want to reset the Airplane mode settings, turn off the wireless network and Bluetooth in the Airplane mode.

If the wireless network is not in use, it is recommended that you turn on the Airplane mode to reduce the power consumption.

Using Software

My gram

My gram suggests an optimal environment customized to a user's PC status, and helps experience various apps provided by LG.

- Select the Start button [] > [All] and run [My gram].
 - Press the [Fn] + [F1] keys to start the app easily.

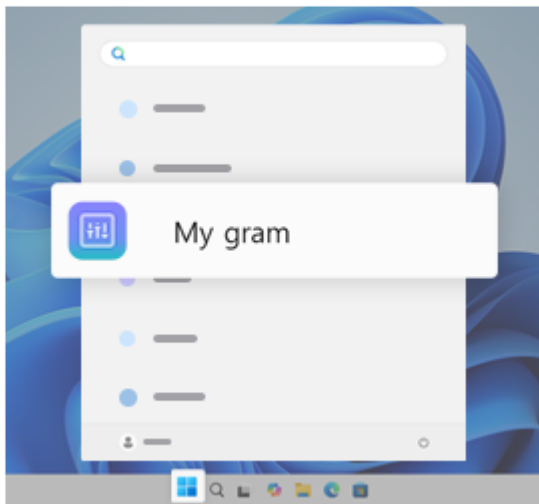

Tip:

The menus and functions displayed in this app may differ depending on the model and app version.

You can re-install the app in LG Update & Renew.

The figures herein are subject to change without prior notice.

Tour

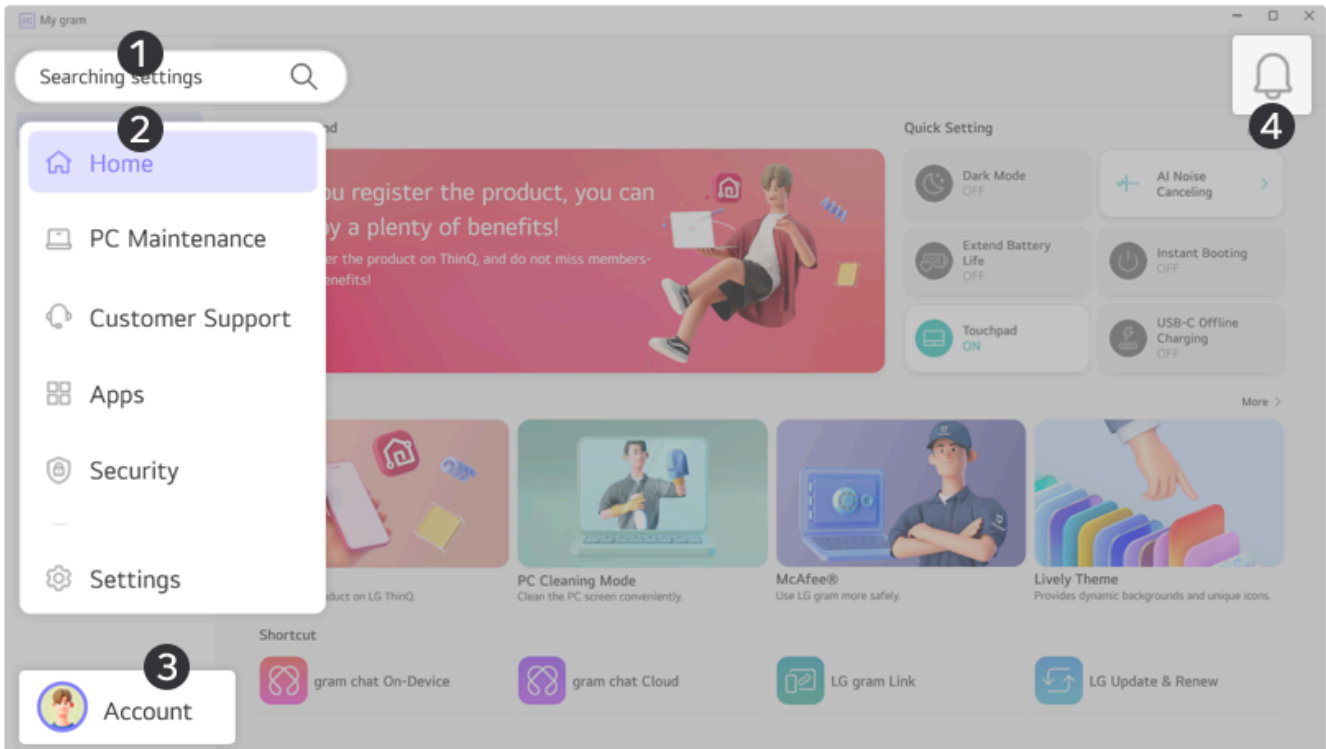

1. Search

You can search and use various settings.

2. Home

The user can receive customized settings depending on your PC status, or set main PC functions easily.

[Learn more >](#)

PC Maintenance

The user can easily change and use various PC functions according to his or her needs.

[Learn more >](#)

Customer Support

Notifies you of the apps or convenient functions provided by LG.

Apps

You can run the apps provided by LG directly.

Security

You can set the function to enhance PC security.

[Learn more >](#)

Settings

You can check app information or use the lab.

3. Account

You can register your PC on your LG ThinQ account.

4. Notification

Notifies the user of important information and updates.

Home

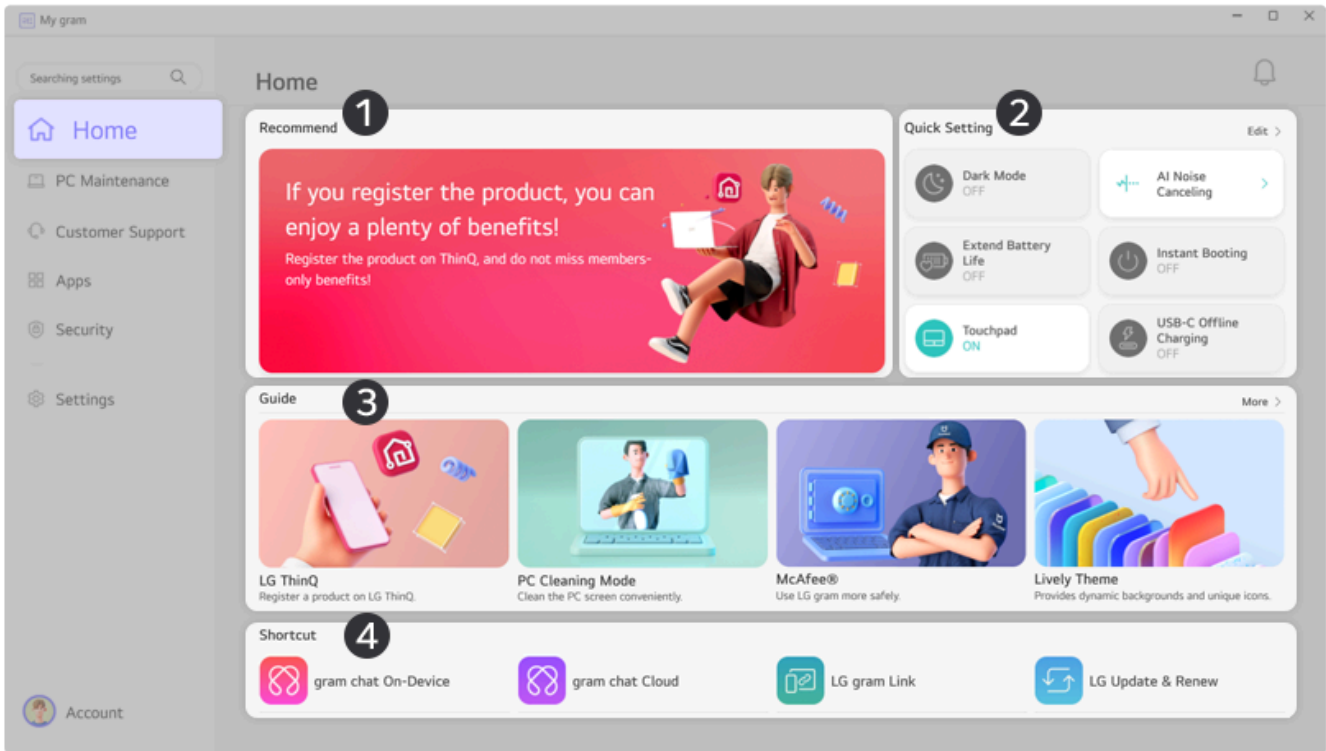

1. **Recommend:** Suggests customized settings according to the user's PC status and provides related links.
2. **Quick Setting:** Allows you to set main PC functions easily. Items can be changed and up to 6 items can be added.
3. **Guide:** Notifies you of the apps or convenient functions provided by LG.
4. **Shortcut:** You can run the apps or websites provided by LG directly.

PC Maintenance

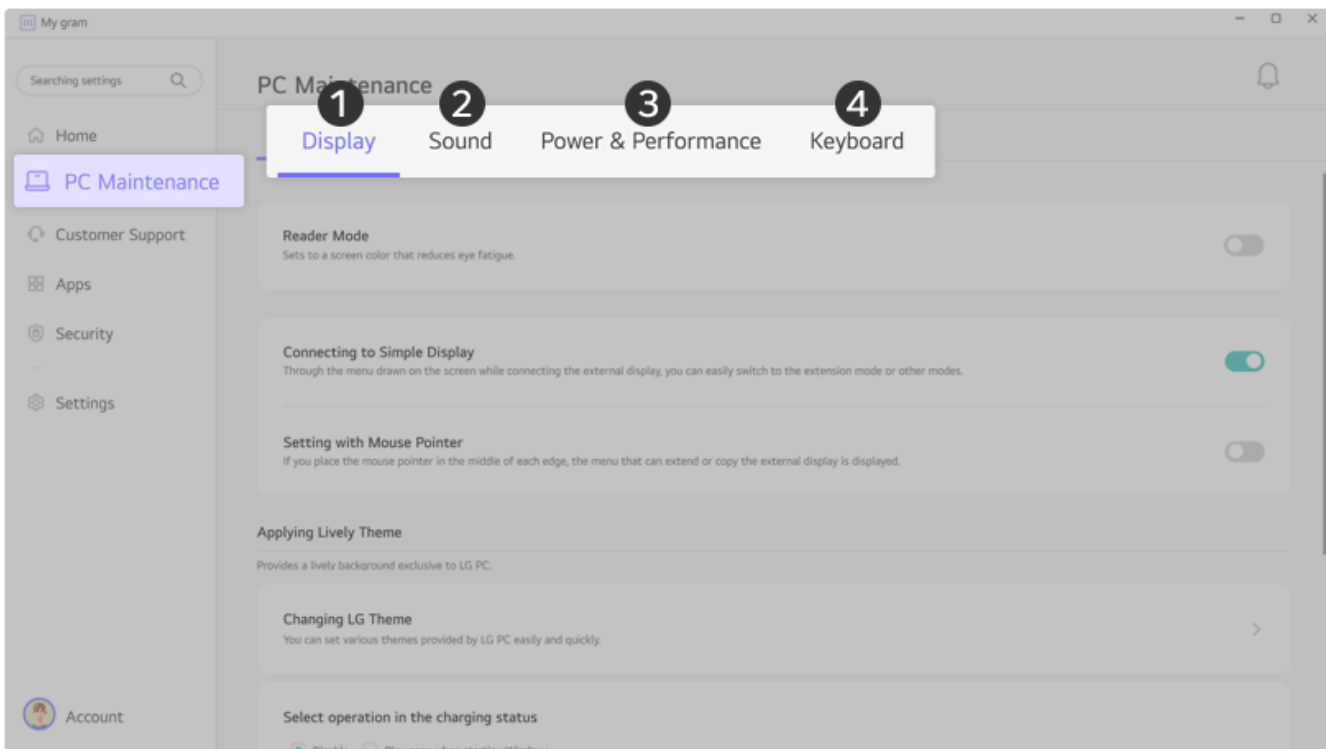

1. Display

Function	Description
Reader Mode	<p>Allows you to set the Reader Mode to reduce eye fatigue when reading documents.</p> <ul style="list-style-type: none">Using the Reader Mode and the Night light at the same time can cause color distortion. When you use the Reader Mode, turn off the Night light. <p>You can turn [Night Mode] on or off in the Start button [] > [Settings] > [System] > [Display].</p>
Connecting to Simple Display	When connecting an external display, you can set to display the menu that can set the Display Mode on the PC screen.
Applying Lively Theme	You can set various themes provided by LG PC or select an operation method of Lively Theme according to the charging status.

2. Sound

*Supported to the built-in microphone/speaker only.

Function	Description
AI Microphone Optimization	Cancels out the noise input to the microphone to deliver clear sound.
AI Speaker Optimization	Cancels the noise output from the speakers to deliver clear sound.
User voice tracking	It removes voices of other users in the surroundings and delivers the registered user's voice only. It can be used in the Uni Directional Noise Canceling mode only.

3. Power & Performance

Function	Description
Cooling Mode	Allows you to set the fan mode of the PC according to the PC environment. Learn more >
Battery Life Status	Displays the battery status so that you can replace the battery timely.
Extend Battery Life	Allows you to lower the battery charge completion level to 80%, or set to extend the battery life through the AI mode that learned the user pattern and PC status.
Turning off the screen by detecting AFK	Allows you to set to turn off the screen automatically by detecting AFK with a camera.

USB-C® Offline Charging	Allows you to set the PC to charge external devices via the USB-C® port even when the PC is turned off.
Battery Saving Mode	You can adjust some of the PC's settings, such as the Power mode, screen and sleep settings, keyboard backlight, display brightness, and Windows Auto Update, to use the battery for a longer duration. (This applies only when the PC adaptor is not connected to the power.)
AI Battery Usage Detection Notification	You can set the PC to use its AI analysis function and alert you when multiple applications or vaccine programs that consume the battery a lot are being used.

4. Keyboard

Function	Description
Keyboard Backlight	You can set whether to use keyboard backlight and brightness, and can set the keyboard backlight to turn off automatically after the designated time.
Lock Fn Key	Allows you to set the hot keys (F1 - F12) to operate even without pressing Fn.
Shortcut Guide	While pressing and holding the [Fn] key, you can set to display the shortcut guide that can be combined with this key.
Display NumLock Key Status	Allows you to set the screen to display the status change when you press the NumLock key.
Display CapsLock Key Status	Allows you to set the screen to display the status change when you press the CapsLock key.
Shortcut Settings	You can register the app or Internet address to set to use as a shortcut, or check the designated shortcut. Learn more >

[Cooling Mode Guide]

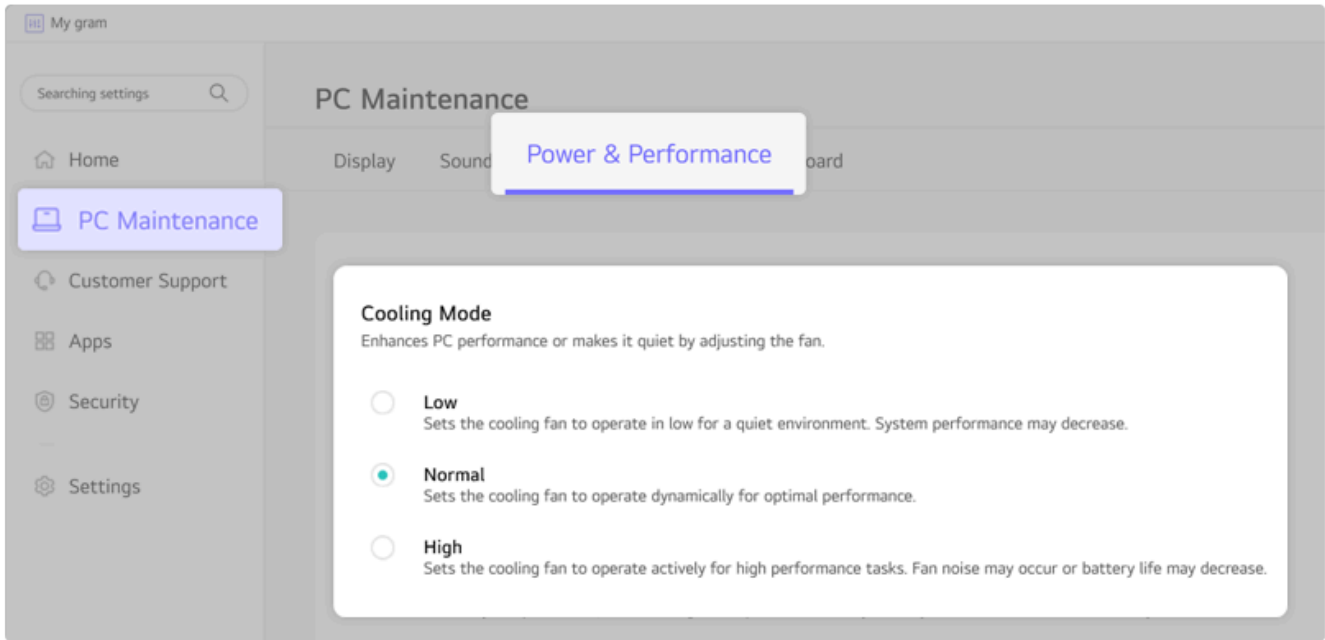

- **Low:** Minimizes fan speed so that you can use the PC in a quiet environment. (This may degrade your PC performance.)
- **Normal:** Optimizes PC performance, heat and noise.
- **High:** Sets to the tasks that require high performance. (This may result in increased PC surface temperature and noise, and shorter battery life.)





Caution:

When using for a long term, use Normal Mode.

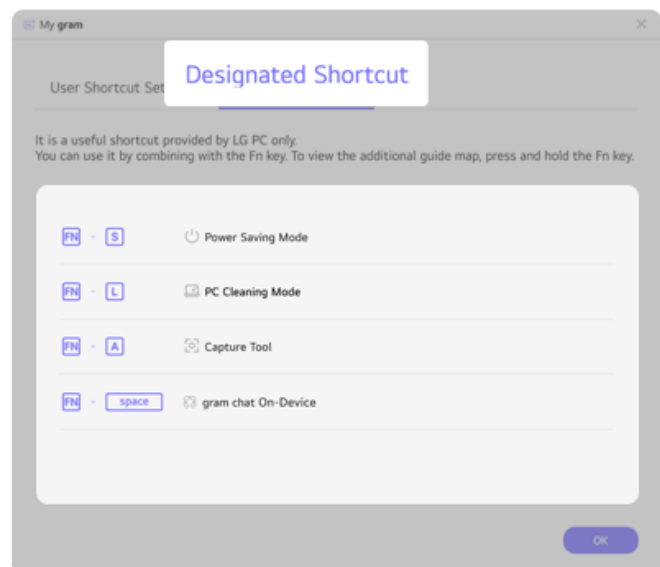
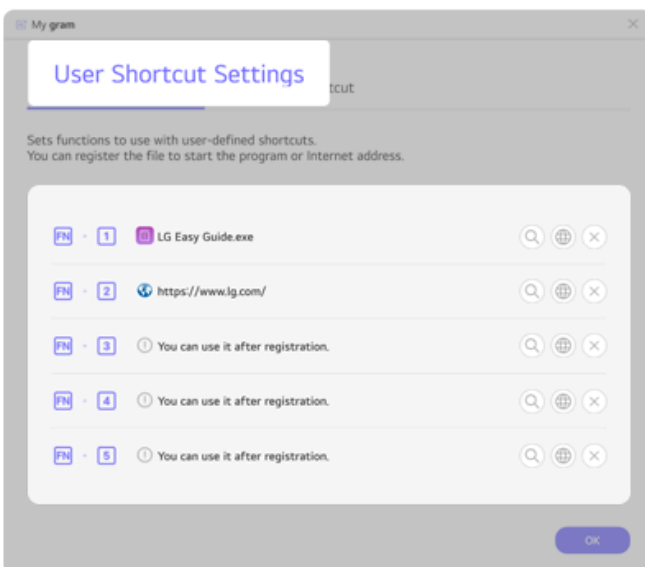
[Shortcut Setting Guide]



- **User Shortcut Settings:** On the Shortcut Settings List, select the navigation icon [] or the internet icon [] to register the desired app or Internet address to a shortcut.



Tip:

Some abnormal program files (exes) and Internet addresses (links) may not be linked.

Shortcuts can be set from 1 to 5.



After selecting the app-running file, right-click the mouse and use the [Show more options] > [Set functions to use with user Hot keys] menu to register the app quickly.

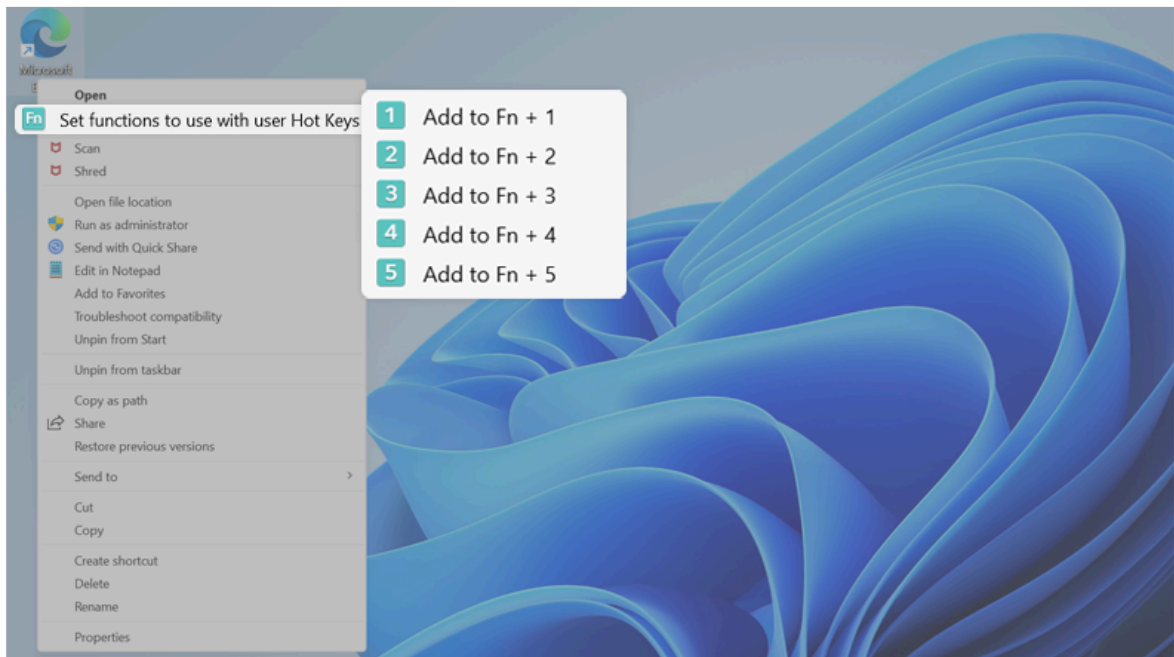

- **Designated Shortcut:** The Fn key can be combined with shortcuts supported only by LG PC to use some functions easily, and the designated shortcuts may not be changed by the user.



Tip:

The PC Cleaning Mode is a function that locks the keyboard, touchpad, and touch screen to stop operating when cleaning the product while the power is turned on. (The touch screen lock function applies only to the model with the touch screen provided.)

Turn off PC Cleaning Mode: Press and hold the [Fn] + [L] keys on the keyboard until the bar displayed on the screen is filled.





Caution:

Do not clean using liquid or solution while the power is turned on.

- A malfunction or fire may occur.

Security

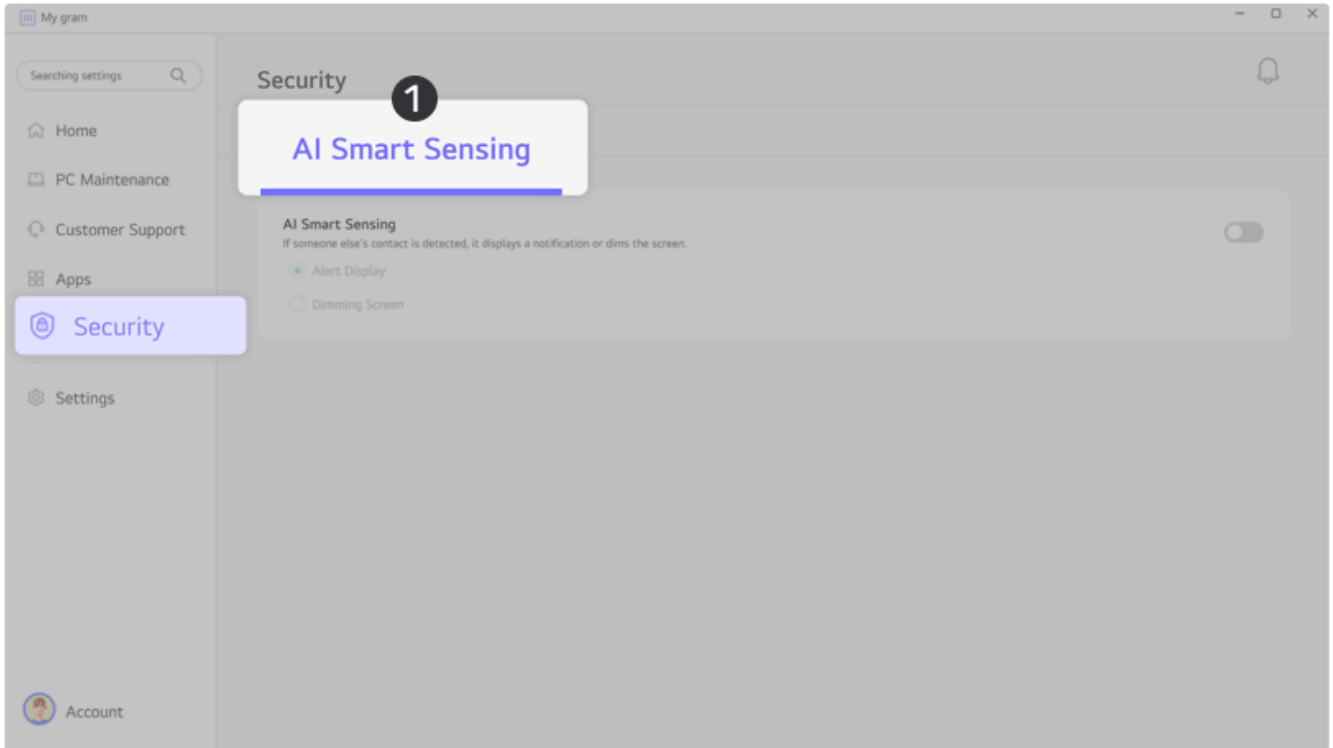

1. **AI Smart Sensing:** Notifies the user of detection of someone else's contact by using the AI-based contact detection function.

LG Update & Renew

LG Update & Renew maintains the system in the optimal state through updates.

- Select the Start button [] > [All] and run [LG Update & Renew].



Tip:

Menus and supported functions may differ depending on the model.
 It may not work properly depending on user environment (security tools, etc.) and the network status.
 Use LG Update & Renew to keep your system current and optimized.
 The figures herein are subject to change without prior notice.

Tour

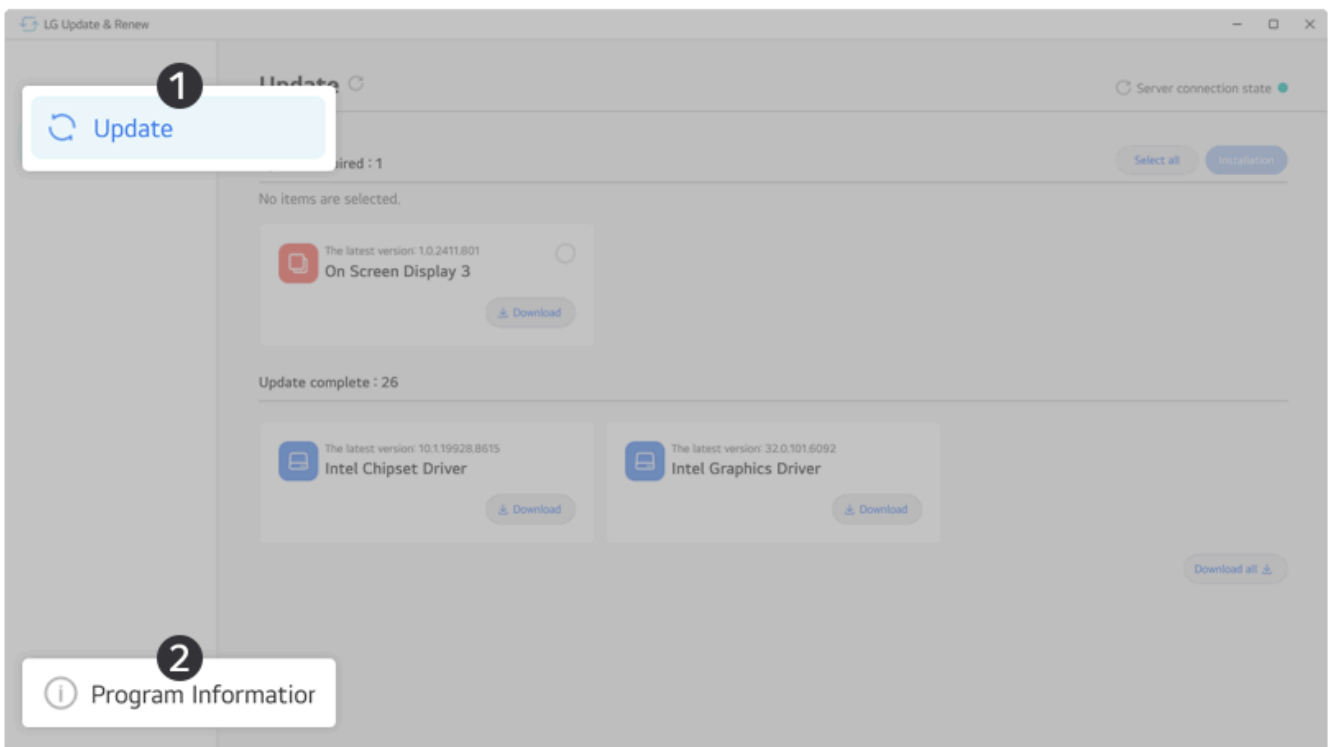

1. Update

Allows you to install various PC drivers, applications and Windows patches easily and quickly.

2. Program Information

Runs Help or displays information about the software.

Update

If an item that needs updating is displayed, you can select it and update it.

- Select an item to update in the [Update] menu and click [Installation].

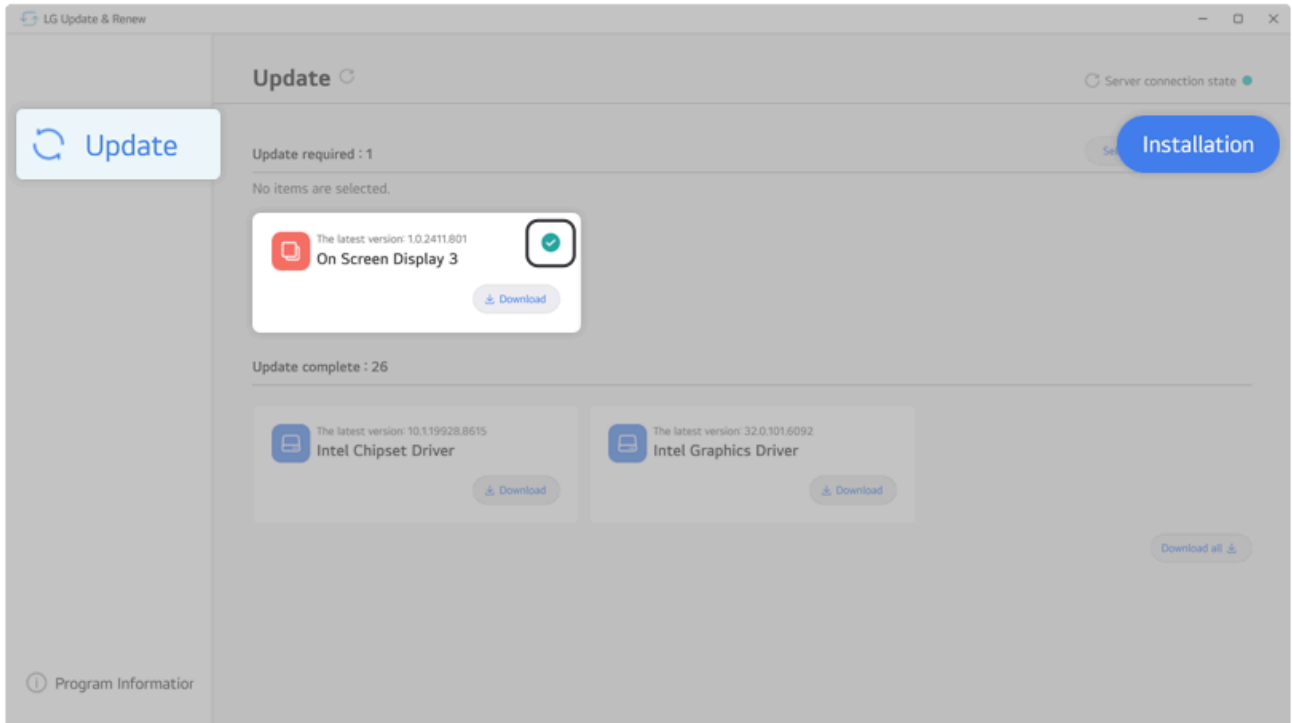

gram chat On-Device

gram chat On-Device helps search information on the PC fast and precisely through the AI technology.

- Select the Start button [] > [AI] and run [gram chat On-Device].
 - Press the [Fn] + [Space bar] keys to start the app easily.

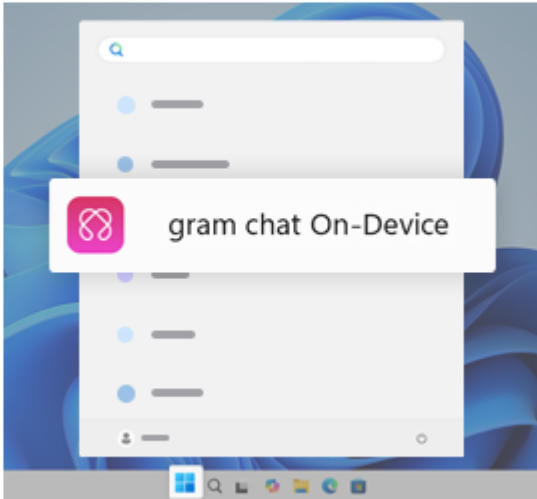

Tip:

gram chat On-Device supports Korean/English input.

The minimum memory capacity to run gram chat On-Device is 16 GB. It is not run in a model whose system memory is configured below 16 GB.

You can re-install the app in LG Update & Renew.

The figures herein are subject to change without prior notice.

Tour

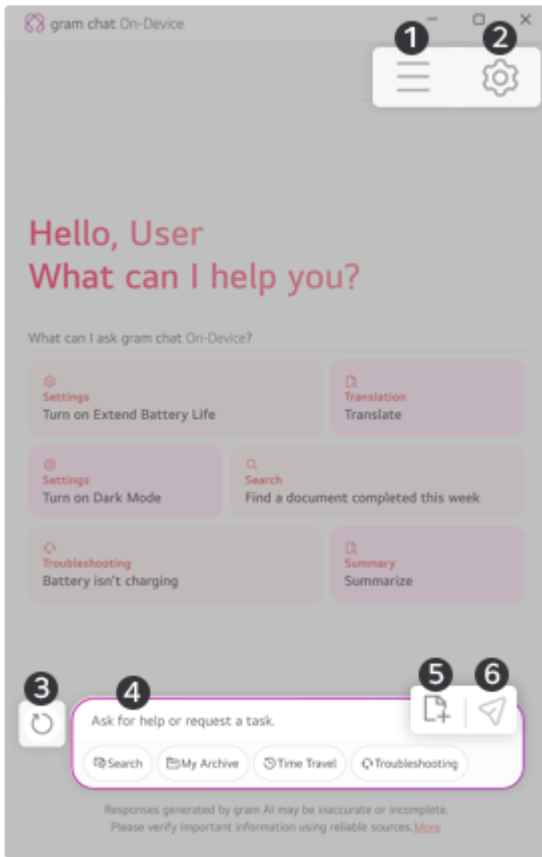

1. **Previous Search List:** A previous search list is displayed.
2. **Settings:** You can check the app information or change app settings.
3. **Indexing Refresh:** Resets the search history.
4. **Search:** Enter the content to search.
 - Depending on a necessary task or help request, you can select a menu you want and search.
5. **Attach File:** You can attach a file.
6. **Send Button:** Press the Send Button to create a response.

LG gram Link

LG gram Link allows you to share various files (photos, videos, documents, etc.) by simply connecting the PC with the mobile device and LG webOS device and to experience expanded usability through various connections between devices.

- Select the Start button [] > [All] and run [LG gram Link].



Tip:

To use LG gram Link, the devices using the app must be connected to the same Wi-Fi network and the app must be running on the devices.

The app may not work properly on some mobile devices and upgrading the operating system of a mobile device may prevent some features from working properly.

You can re-install the app in LG Update & Renew.

The figures herein are subject to change without prior notice.

Registering the Mobile device and LG webOS device

1. Scan the QR code with the camera app of the mobile device and install the app on the mobile device.



Tip:

You can search LG gram Link on Google Play or App Store and install the mobile device app.

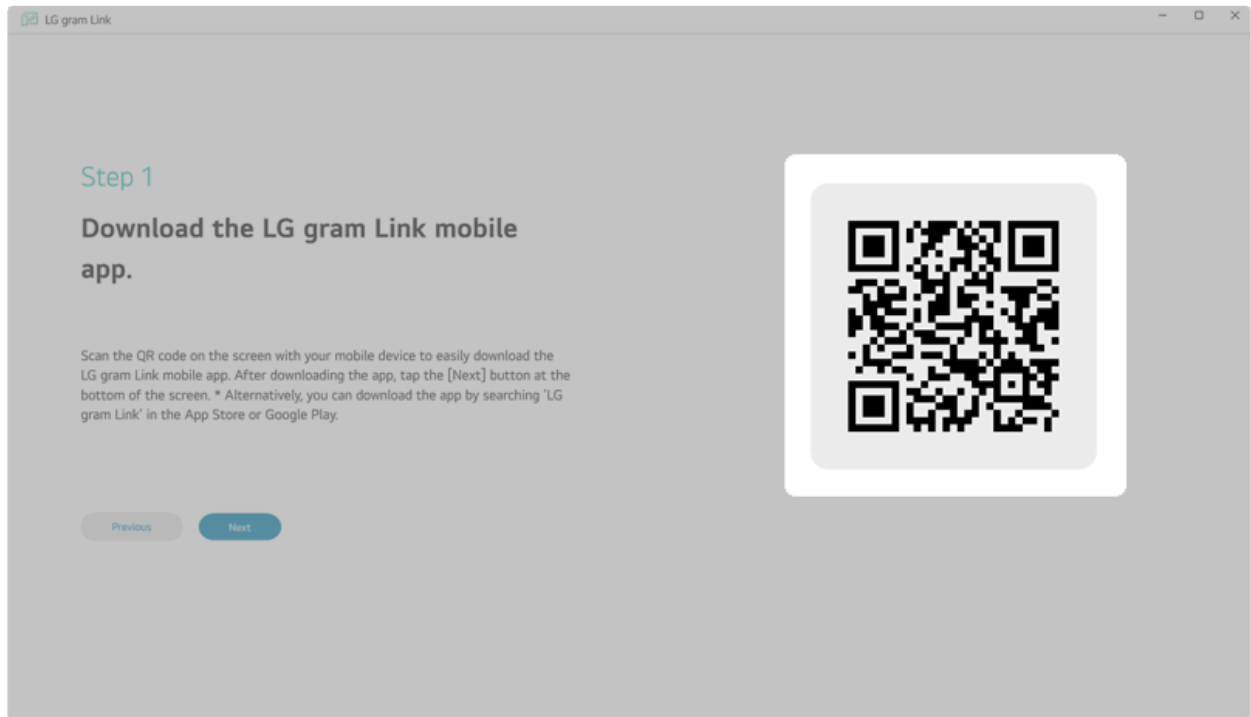

2. When the installation is complete, press [Next].
3. Connect the PC and device to register to the same Wi-Fi network.
4. Register the mobile device and LG webOS device as follows:
 - Mobile Device: In the LG gram Link app of the mobile device, select [Register to your gram] and scan the QR code on the PC screen.
 - LG webOS Device: In the [LG Gallery+] app of the LG webOS device, select [Generative AI] > [Recently produced images] > [Send]. Once LG Link is launched, select [Add Device] > [Generate a PinCode]. Enter the numeric code to the PC.



5. When the registration is complete, press [OK].

Tour

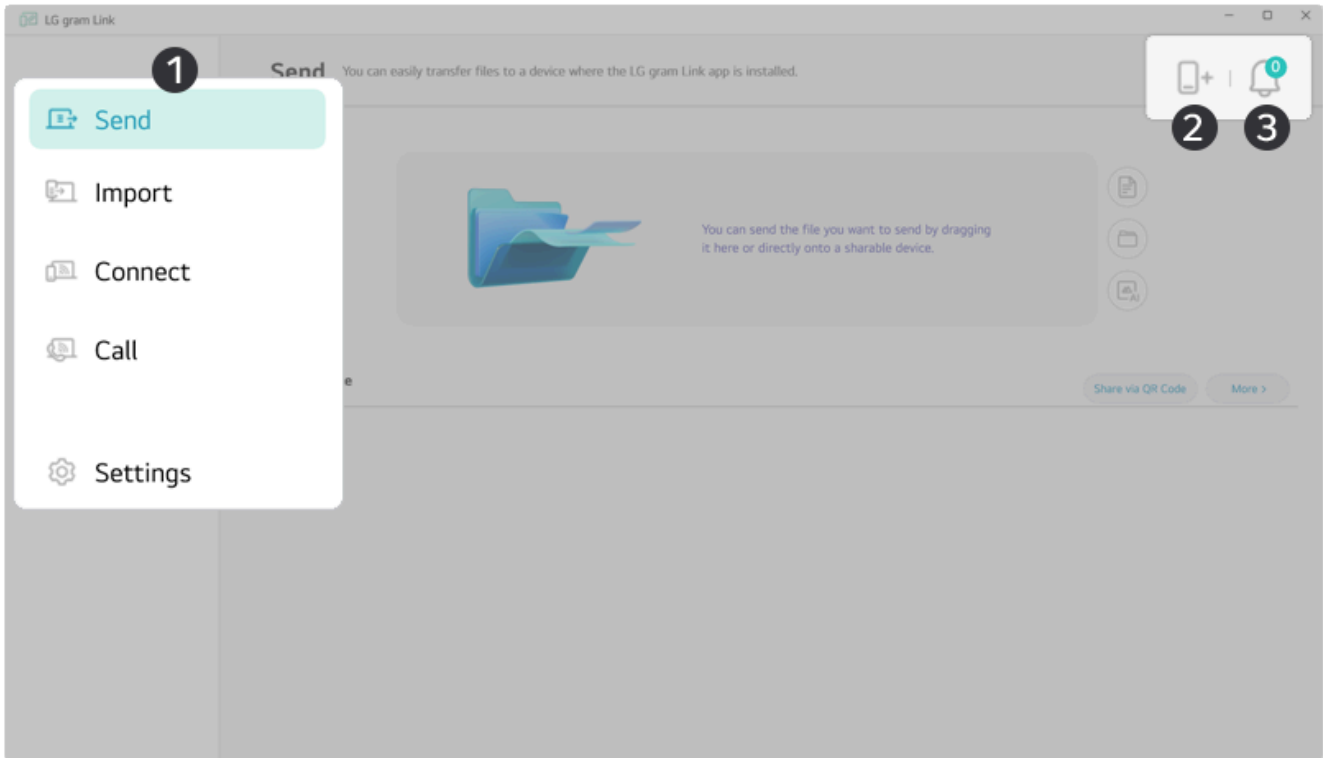

- 1. Send:** Allows you to send files (photos, videos, and documents) stored in your PC to other devices.
Import: Allows you to import photos and videos from the mobile device to your PC or to other registered devices.
Connect: Allows you to experience expanded usability through various connections between devices.
Call: Checks the contacts on the mobile device, or makes a call directly on the PC.
Settings: App settings and registered mobile devices can be managed.
- 2. Device registration button:** Allows you to register devices additionally.
- 3. Notifications:** Allows you to check the notifications of the mobile device.
 - Activate [Connect Device for Call/Notifications] in [Settings] and select the device to check notifications.

Send

- In the [Send] menu, drag and drop the files (photos, videos, and documents) that you want to the area marked with dotted lines.
 - You can use the Send File function faster by dragging and dropping files to the icon of a discovered device.

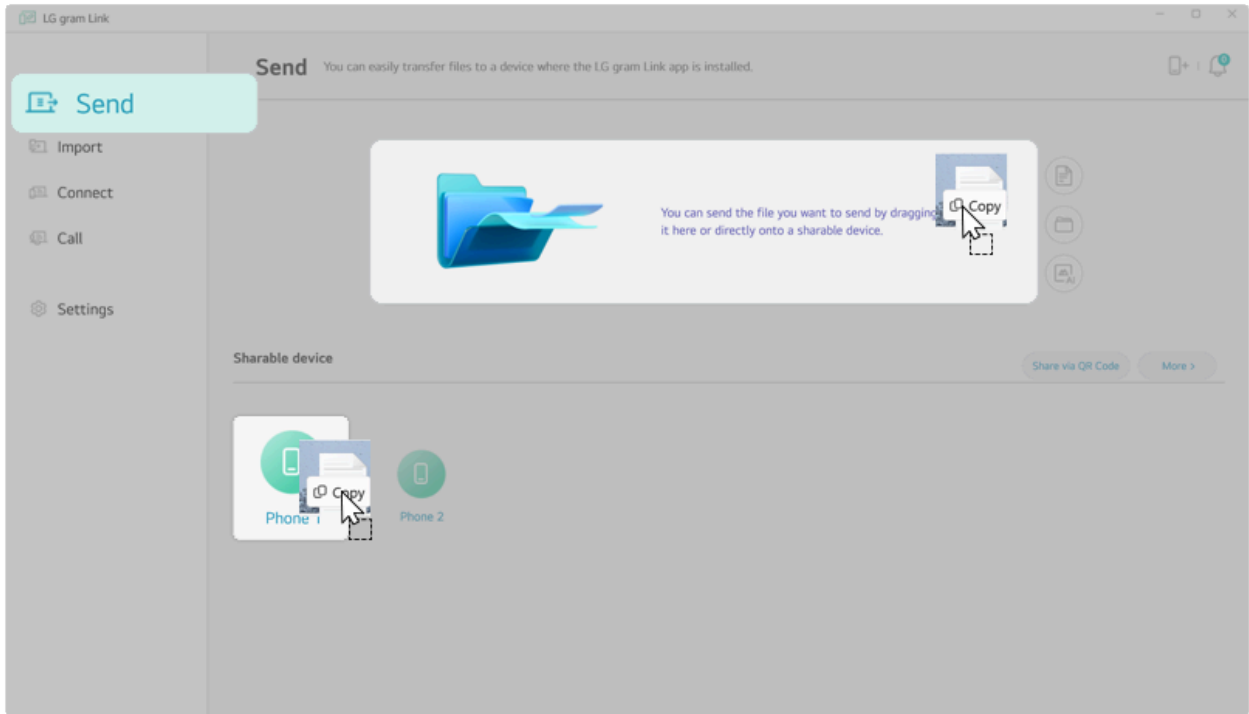

2. When you select the device icon, the files are sent.

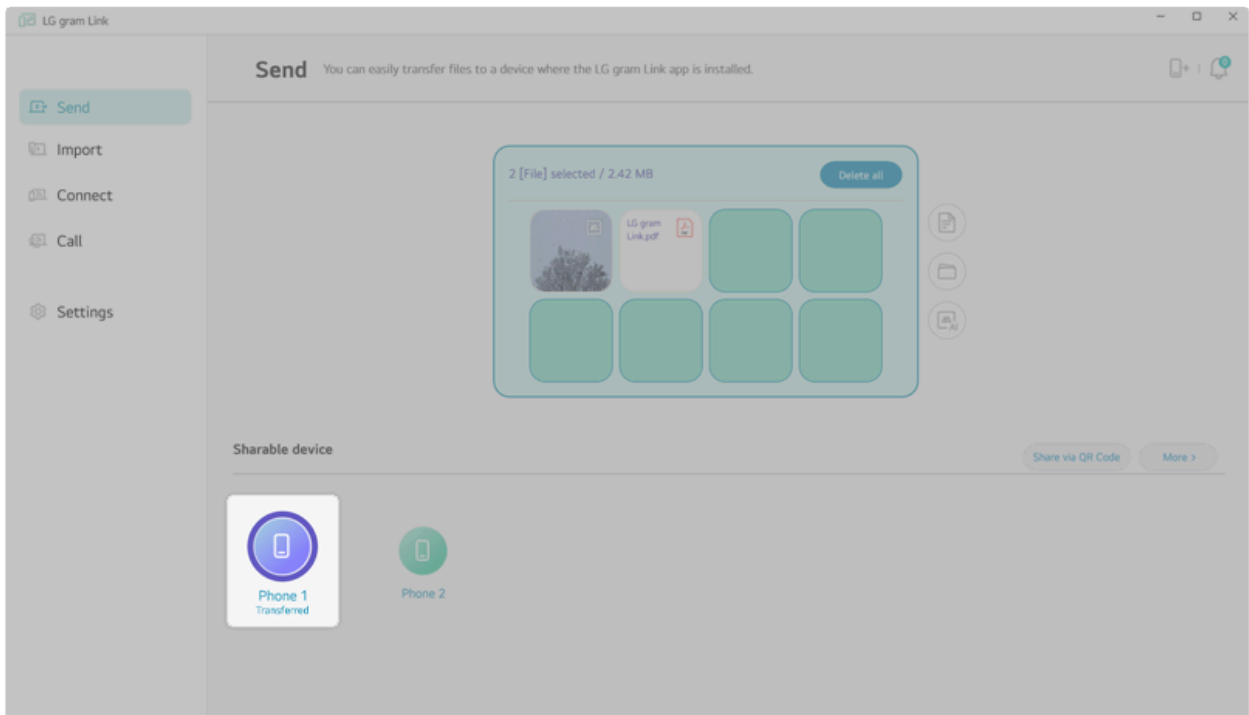

Tip:

- If the device icon does not appear, select [More] to search again.
If the device is not searched continuously, refer to the content in [Reconnecting to Bluetooth](#).
- When you send a file to a non-registered device, you need to enter the PIN code. You only need to enter the PIN code once. Devices with past connection history do not display the PIN code input screen.

Import

1. In the [Import] menu, select a device to connect.

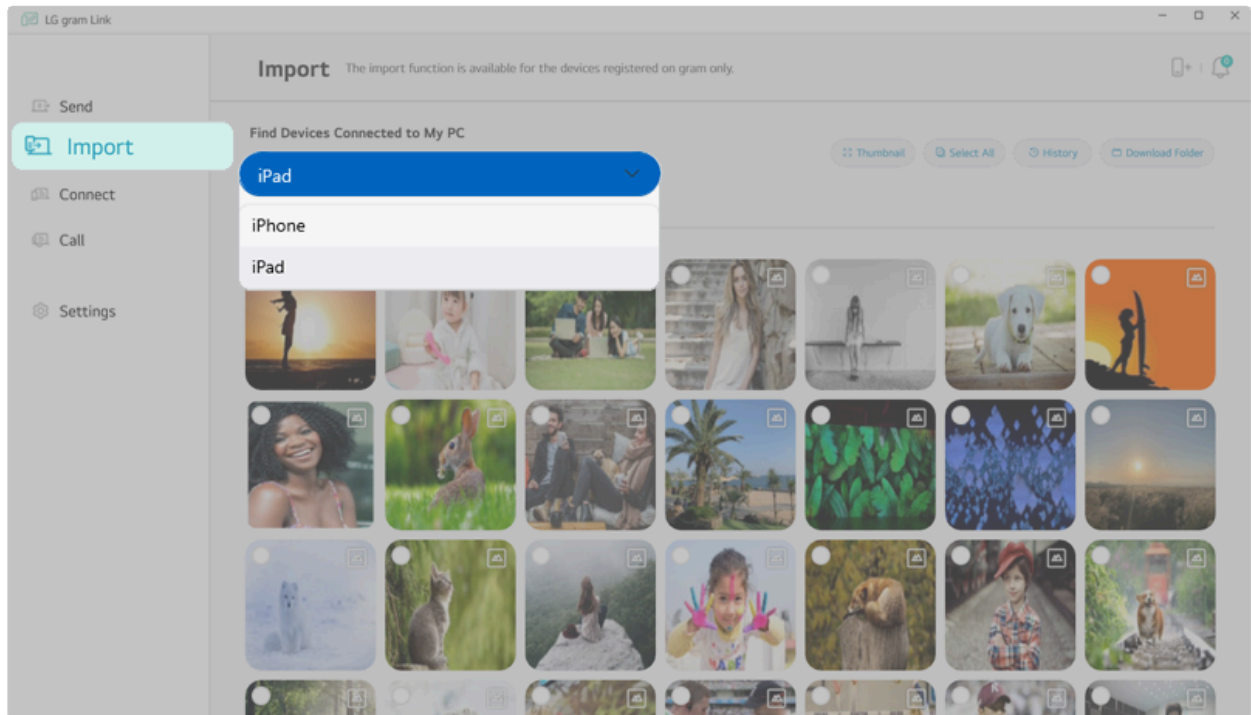

2. When the mobile device's album is displayed on the app, select the photos or videos you want.

- Select [Save] to save the selected files in the PC.
- Select [Deliver] to send the selected files to other registered mobile devices.

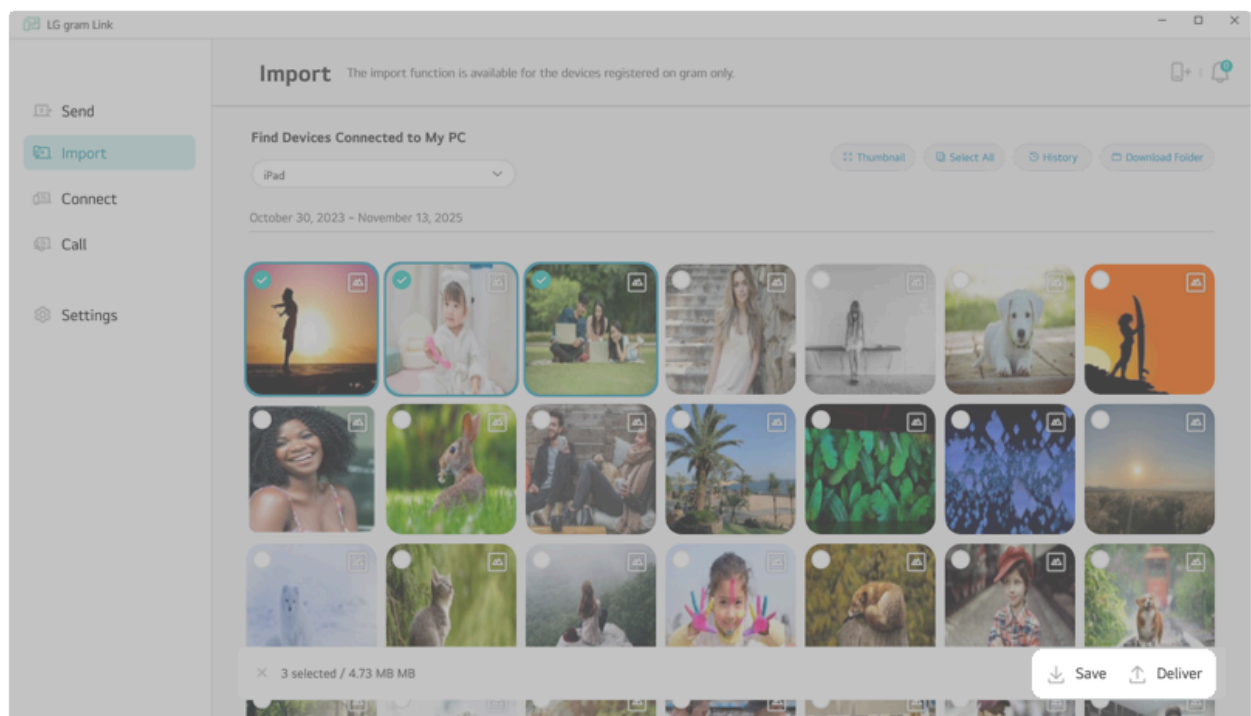



Tip:

The saved files can be found in [Settings] > [Download location].

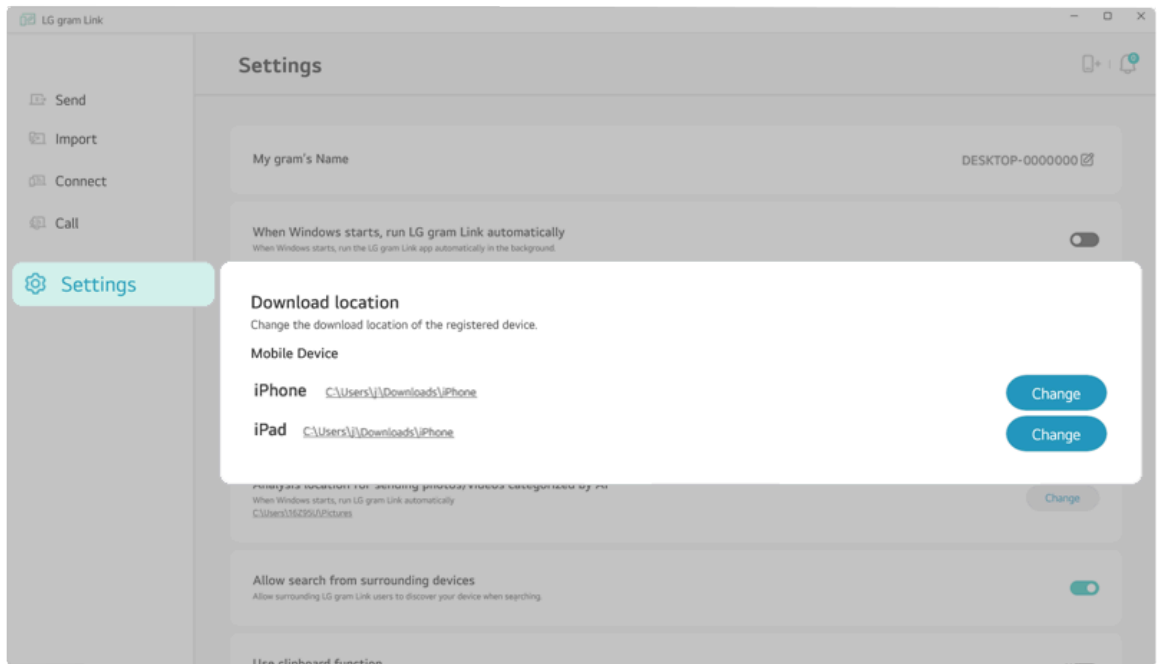

Connect

1. In the [Connect] menu, select the menu for a desired function and connect to the device.

- If you select the [] icon, you can change a device to connect.

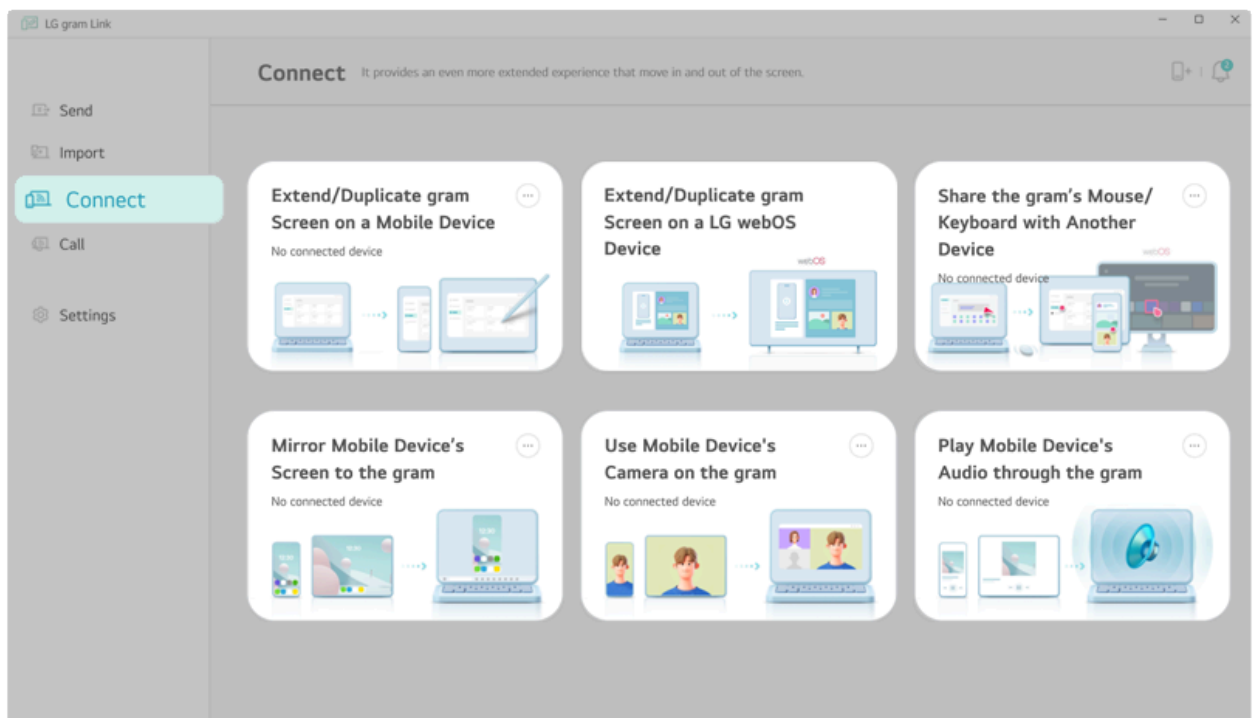

Function	Description
Extend/Duplicate gram Screen on a Mobile Device	You can extend/duplicate the PC screen on the mobile device.
Extend/Duplicate gram Screen on a LG webOS Device	You can extend/duplicate the PC screen on the LG webOS device.
Share the gram's Mouse/Keyboard with Another Device	You can use the PC's keyboard and mouse on the mobile device or LG webOS device.
Mirror Mobile Device's Screen to the gram	The screen of the mobile device appears on the PC, and you can use the mobile device on your PC. <ul style="list-style-type: none"> • If you want to stop using the PC's keyboard and mouse on the mirrored mobile device screen, press [Esc] key.
Use Mobile Device's Camera on the gram	The camera screen of the mobile device is displayed on the PC.
Play Mobile Device's Audio through the gram	You can play the audio of the mobile device through the PC's speaker.



Tip:

- If your keyboard or mouse does not work on the mobile device screen, refer to the content in [Reconnecting to Bluetooth](#).

2. Select the menu again to disconnect the device.

Call

1. Activate [Connect Device for Call/Notifications] in [Settings] and select the device to connect.

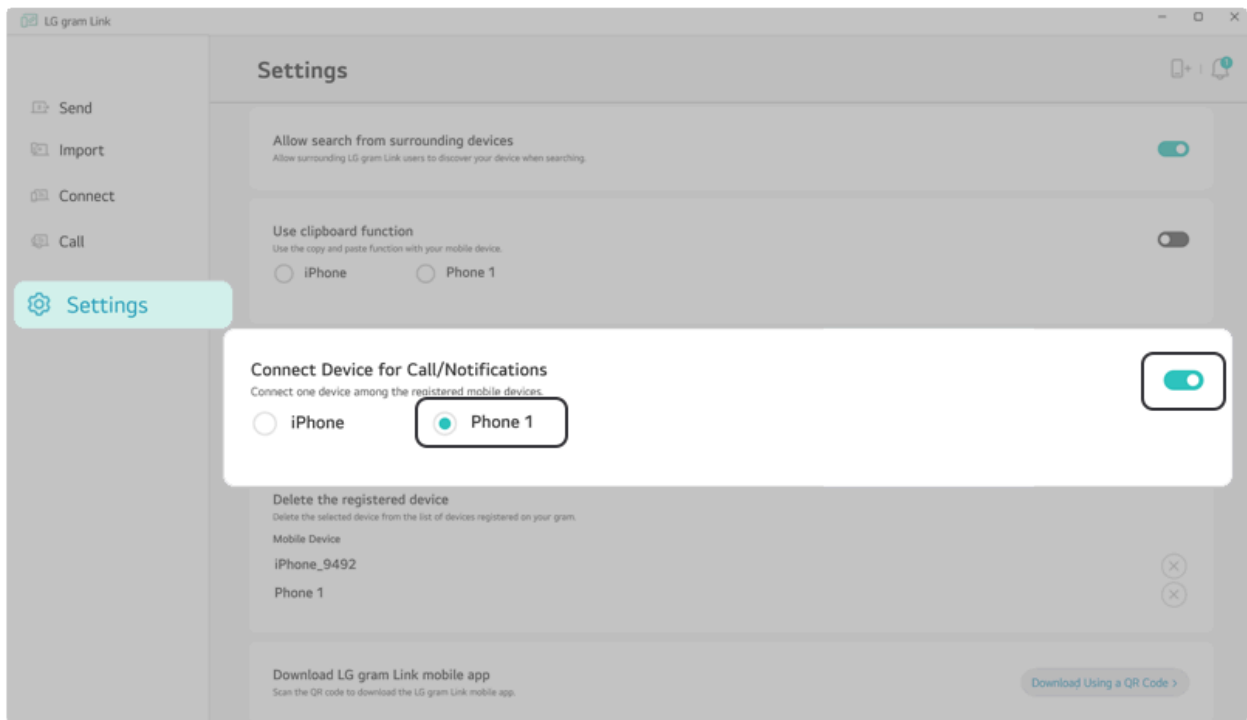

2. Select [Call] > [Connect Bluetooth].
3. If a connection is established, the recent call list appears and you can make a call directly on the PC.

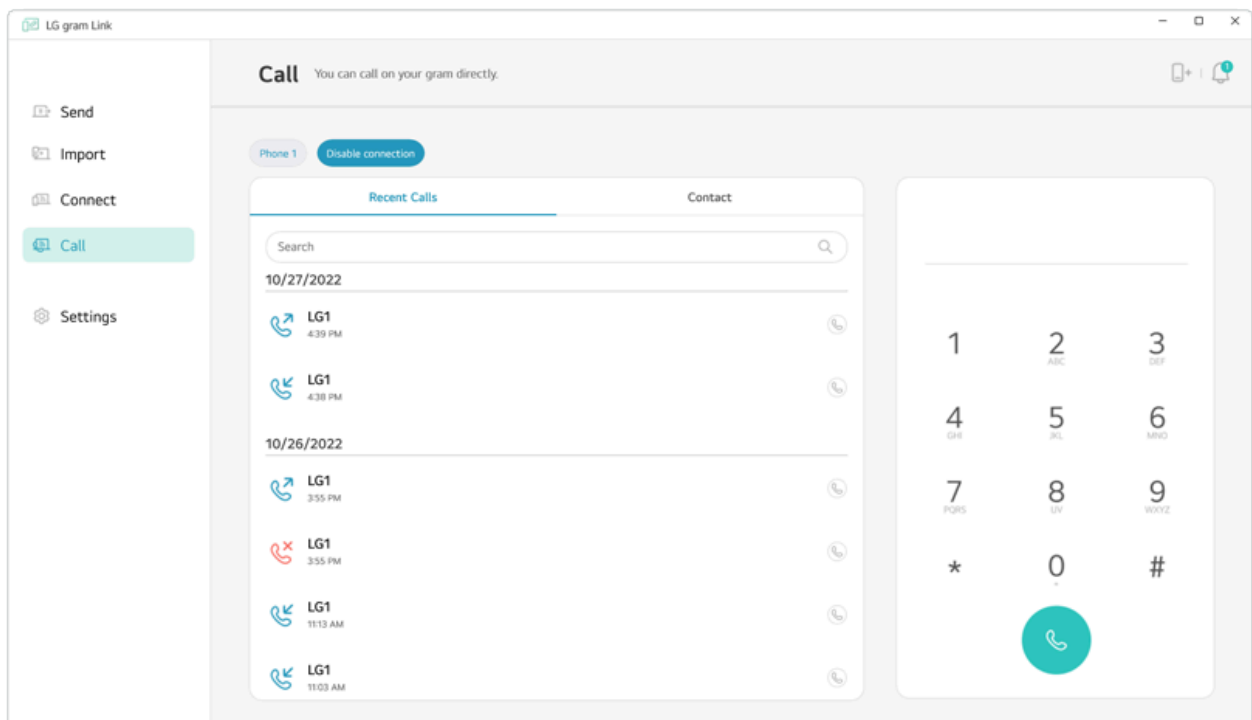

Importing Files on the PC on the Mobile Device

You can import files (photos, videos, and documents) on the PC on the mobile device.



Tip:

Files may be saved in different locations depending on the file format and mobile device.

(Android: Gallery, My Files / iOS: Photos, Files)

[Import Using QR Code]

1. In the [Send] menu on the LG gram Link PC app, drag and drop the files (photos, videos, and documents) that you want to the area marked with dotted lines. After that, select [Share via QR Code].

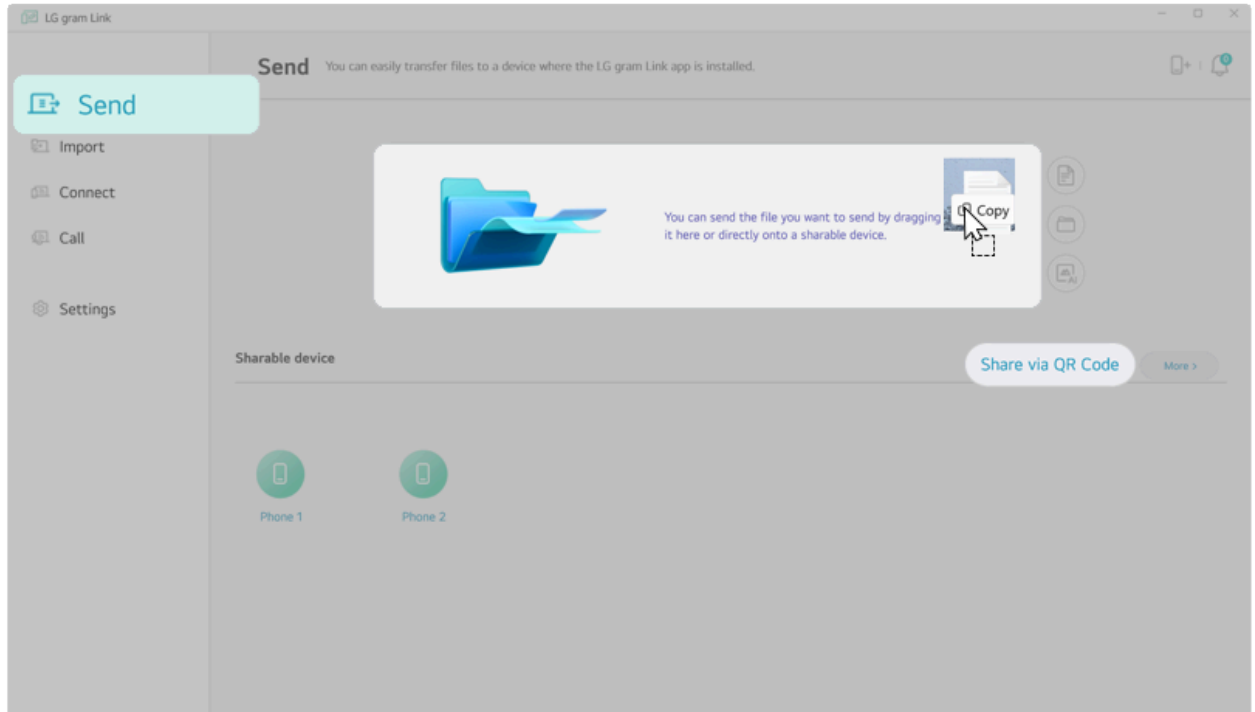

2. Scan the QR code in [Import] > [Import Using QR Code] of the LG gram Link mobile app to save files on the mobile device.

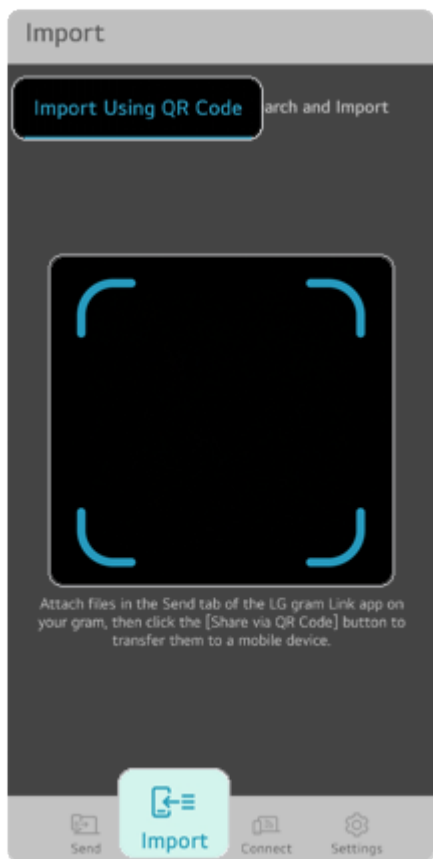

[Search and Import]



Tip:

This function is provided by linking with gram chat On-Device, so you can use it by running gram chat On-Device once.

The mobile device must be registered in the LG gram Link PC app.

1. Search files in [Import] > [Search and Import] menu of the LG gram Link mobile app.

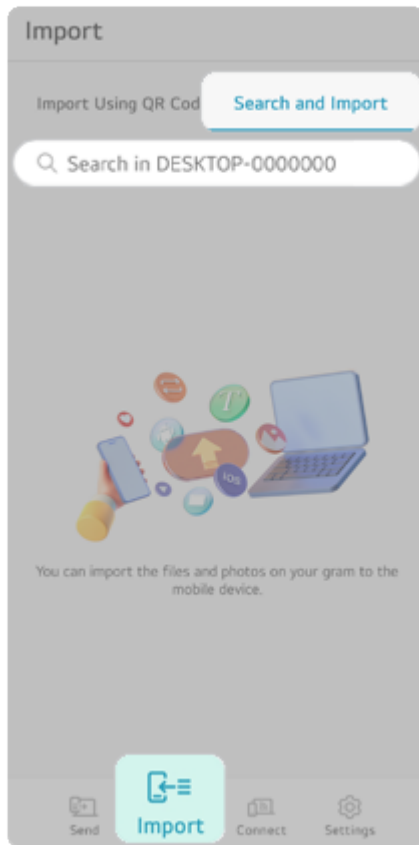

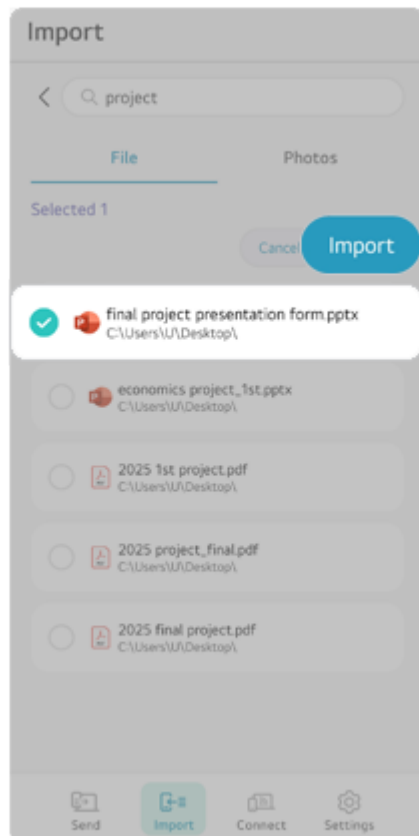

2. Check the desired files and select [Import] to save on the mobile device.

•





Reconnecting to Bluetooth

When no device is discovered / When the PC's keyboard or mouse does not work on the mobile device screen:

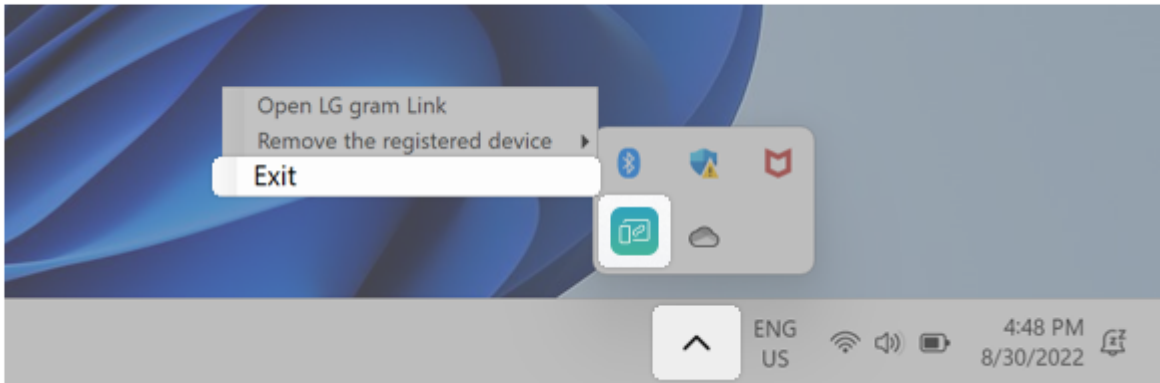
1. Select the [] icon on the right side of the taskbar, right-click the [] icon, and press [Exit] to exit the app.



2. Select the Start button [] > [Settings] > [Bluetooth & devices], press the [] icon for the mobile device, and press [Remove device] to remove the mobile device.

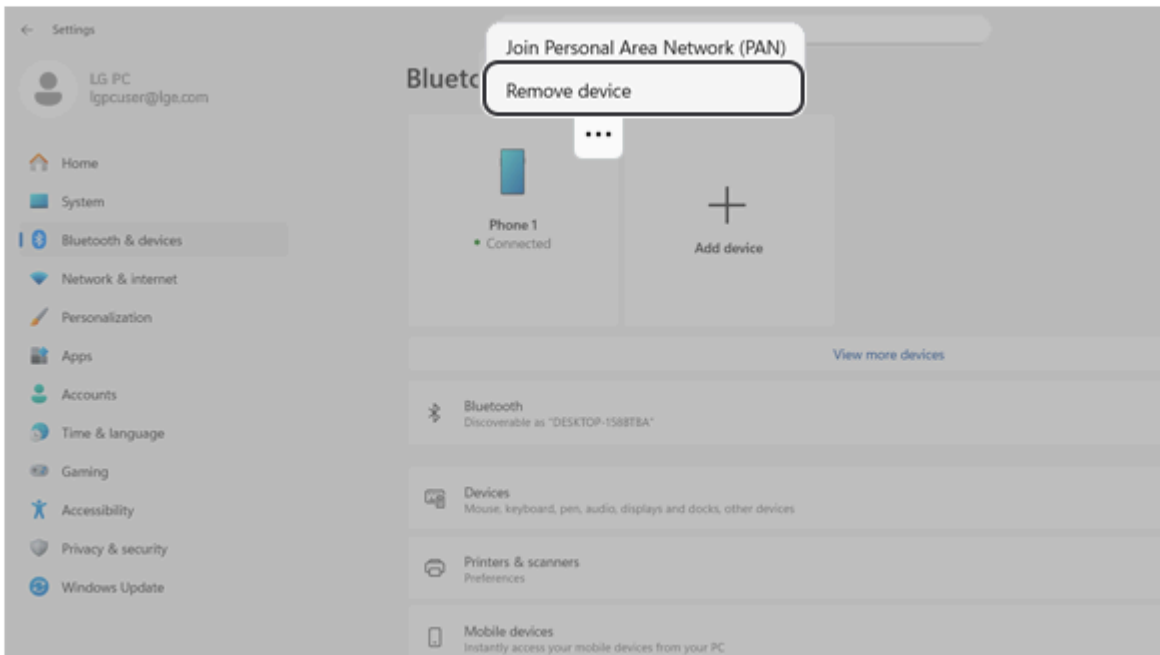

3. In the Bluetooth settings for the mobile device, remove the connected PC.
4. Turn off the Bluetooth function of the PC and the mobile device, wait for 10 seconds, and turn it back on.
5. Run the LG gram Link app and reconnect the PC.

Dolby Settings

Dolby Settings helps use Dolby Atmos effects that provide accurate and ample sounds according to the situation.

- Select the Start button [] > [All] and run [Dolby Settings].

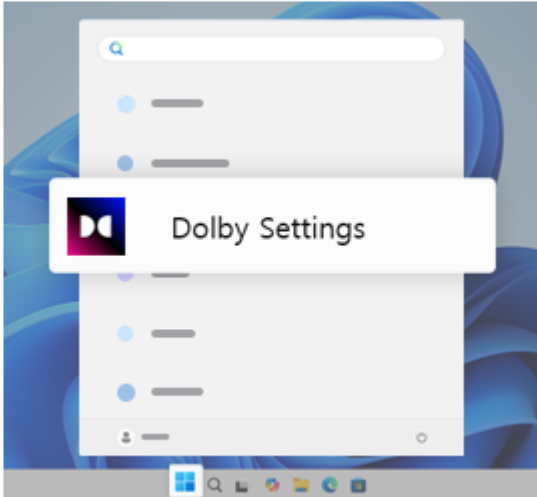

Tip:

This app may not be provided depending on the model.

You can re-install the app by searching Dolby Settings in Microsoft Store.

The figures herein are subject to change without prior notice.

Tour

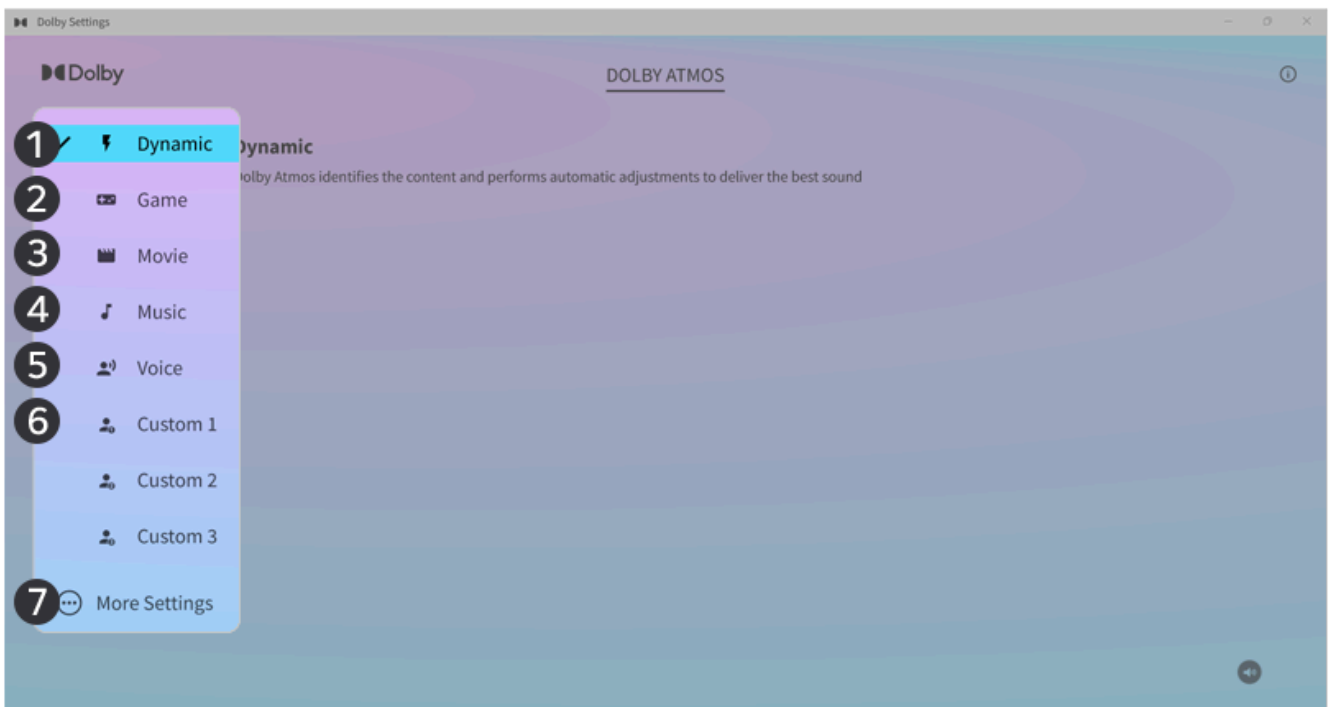

1. **Dynamic:** Provides optimized sounds for contents in operation.
2. **Game:** Provides optimized sounds for running a game.
3. **Movie:** Provides optimized sounds for movie playback.
4. **Music:** Provides optimized sounds for music playback.

5. **Voice:** Provides optimized sounds for voice playback.
6. **Custom 1, 2, 3:** Provides optimized sounds according to user settings.
7. **More Settings:** Allows you set other settings such as deactivating Dolby Atmos effects.

Restoring the System

Restoring the System

If the system has an error, you can use Windows' recovery function to recover or restore the system to its initial pre-purchase state.



Caution:

If you have deleted the restoration data in the protected area of the disk, or have arbitrarily installed another operating system, the restore function may not work.

To recover the system, the adapter must be connected.

1. Select the Start button [] > [Settings].



Tip:

Press the [] key or [Ctrl] + [Esc] on the keyboard to display the Start screen.

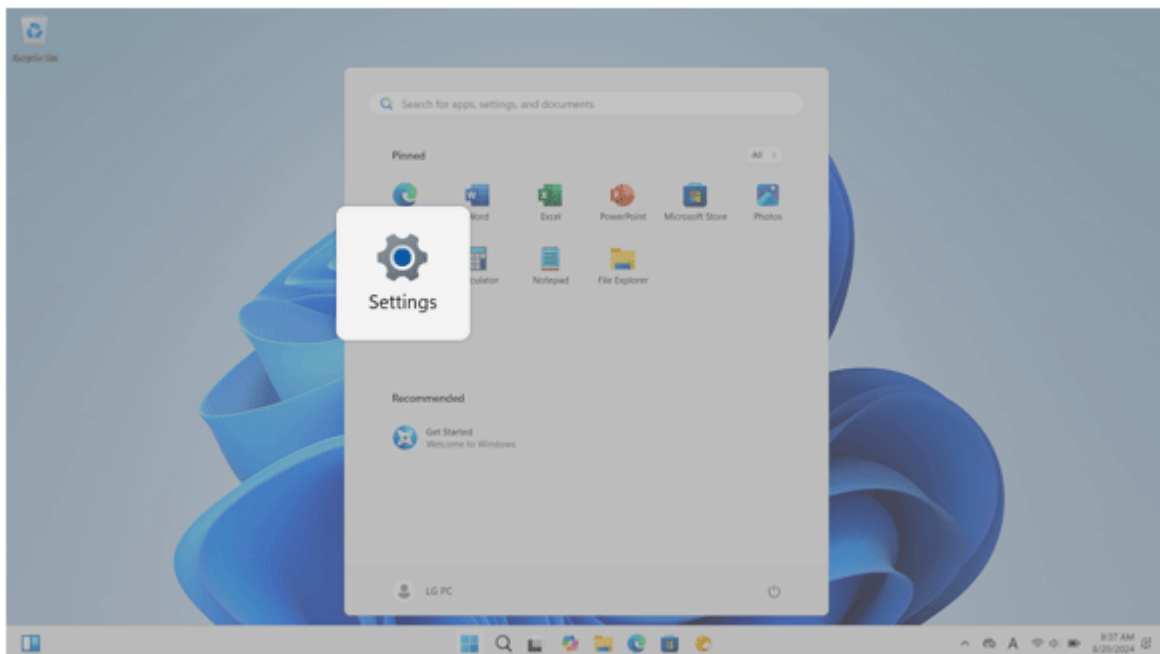

2. Select [Reset PC] in [System] > [Recovery] > [Reset this PC].

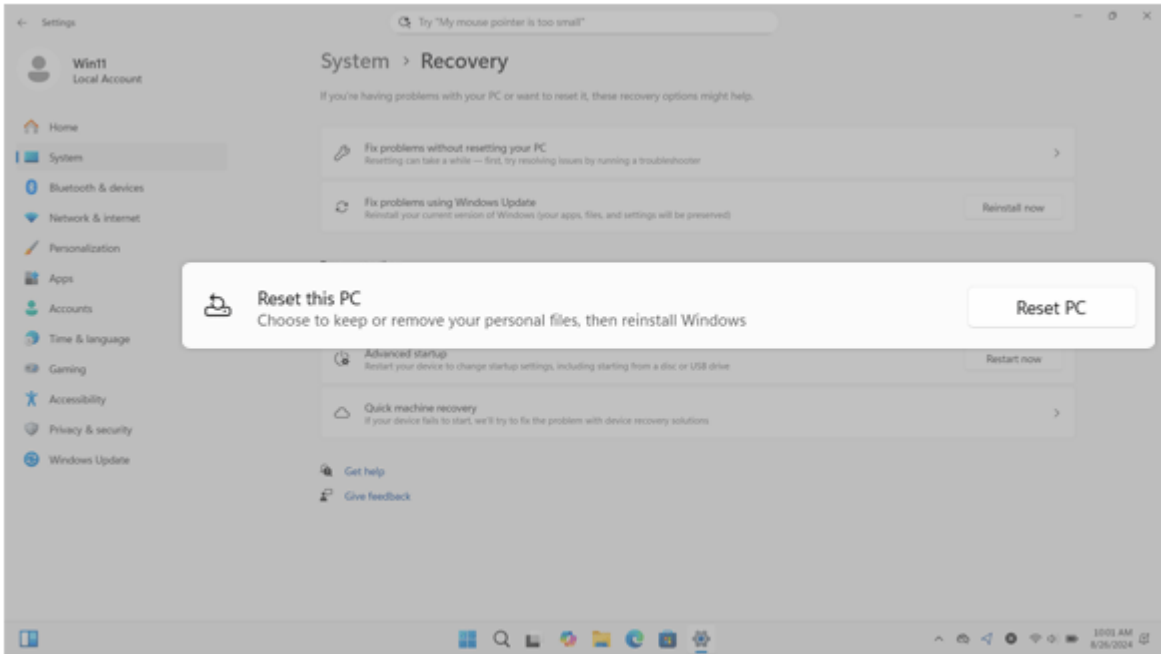

3. Select the options you want to proceed with the recovery.

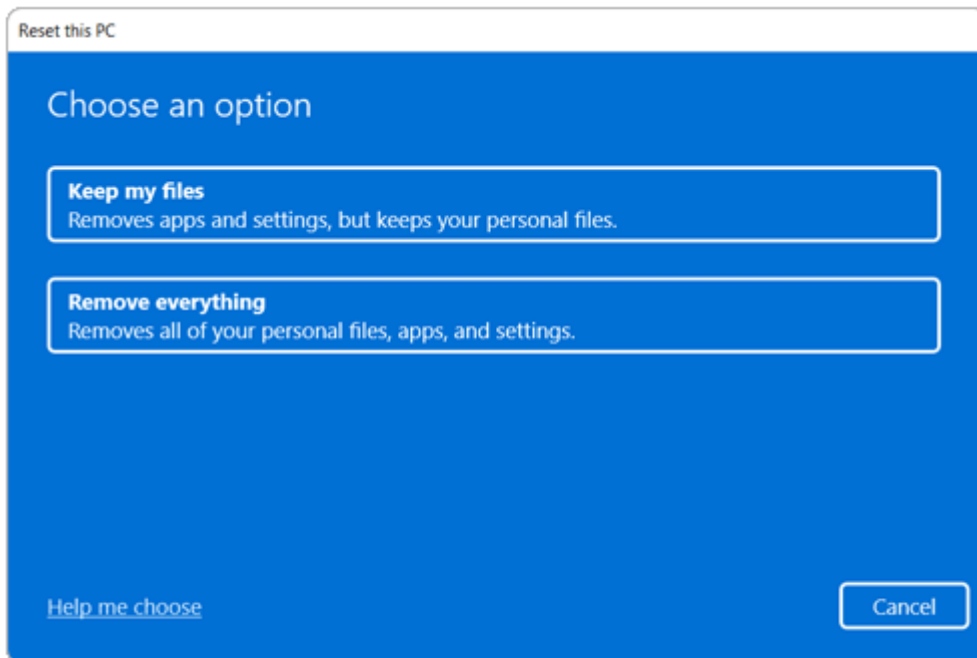

Keep My Files

It removes the apps and their settings without loss of personal files.

1. Select [Keep my files].

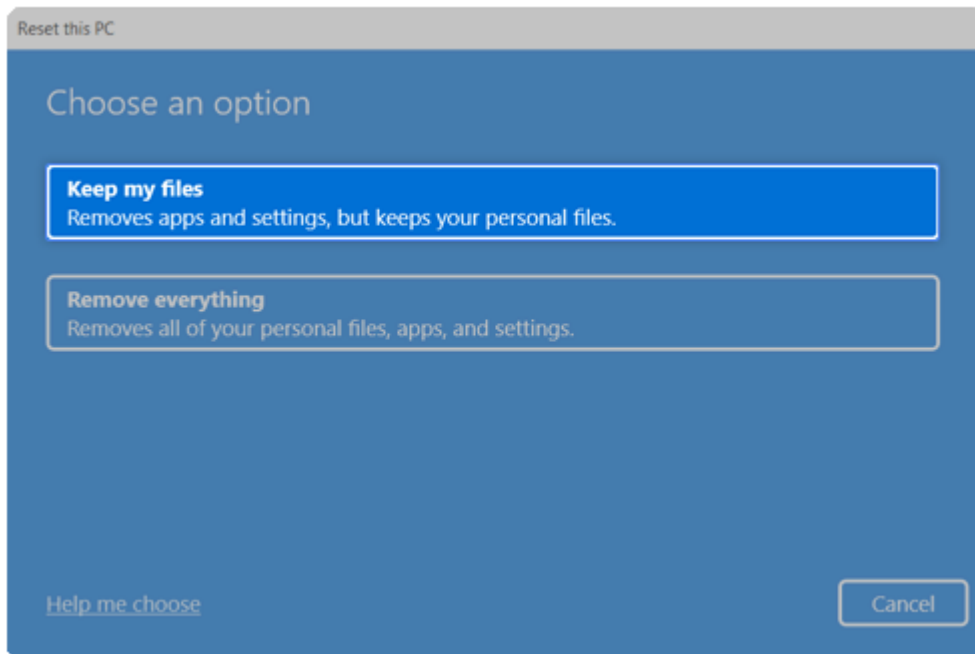

2. Select How to Reinstall Windows.



Tip:

If the PC is not connected to the Internet, the screen for selecting Windows installation method does not appear.

[Cloud download] is a menu for downloading Windows from Microsoft Cloud Server and reinstalling it.

The required time may vary depending on the Internet speed.

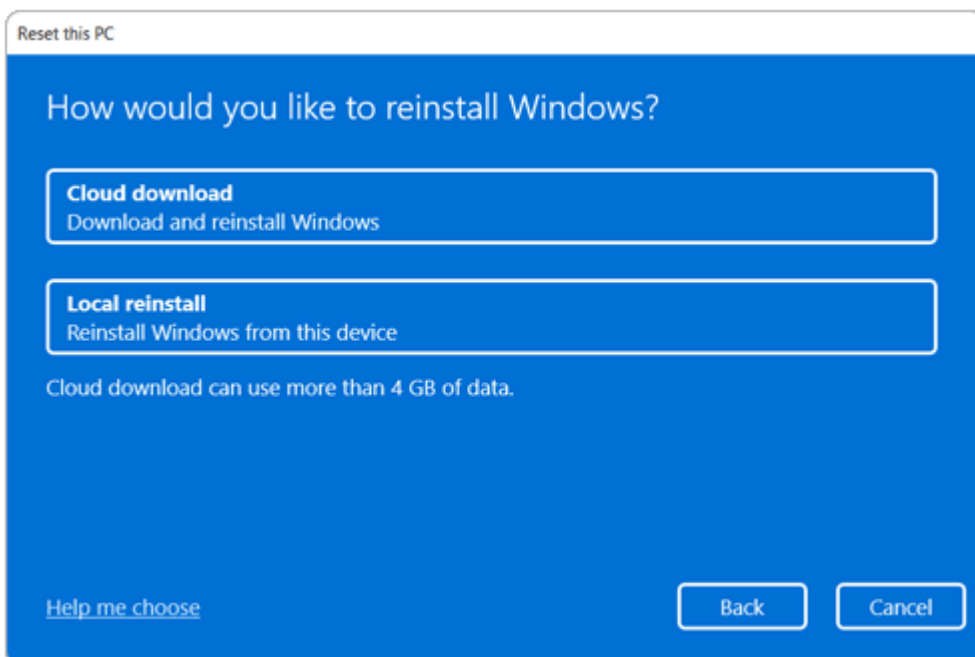

3. Check the current settings and select [Next] to perform the recovery according to the instructions.



Tip:

If you select [Change Settings], you can change the current settings.

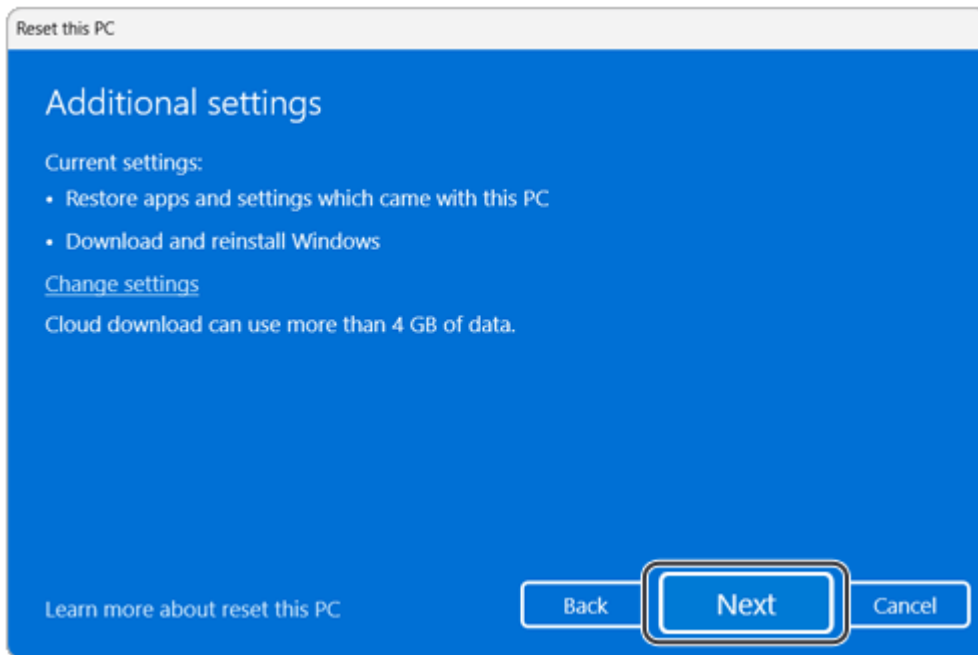

Remove everything

Removes all items from the system and restores the system to its initial pre-purchase state.



Caution:

All data is lost during the initialization, so you must backup all critical data in advance.

It may take about 5 hours or longer depending on the system conditions.

1. Select [Remove everything].

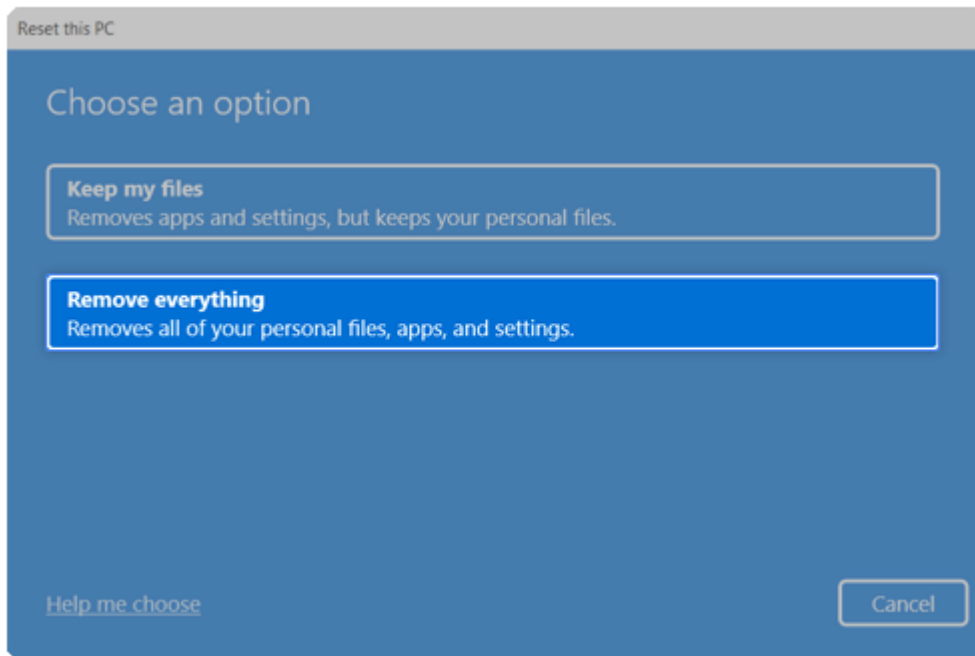

2. Select How to Reinstall Windows.



Tip:

If the PC is not connected to the Internet, the screen for selecting Windows installation method does not appear.

[Cloud download] is a menu for downloading Windows from Microsoft Cloud Server and reinstalling it.

The required time may vary depending on the Internet speed.

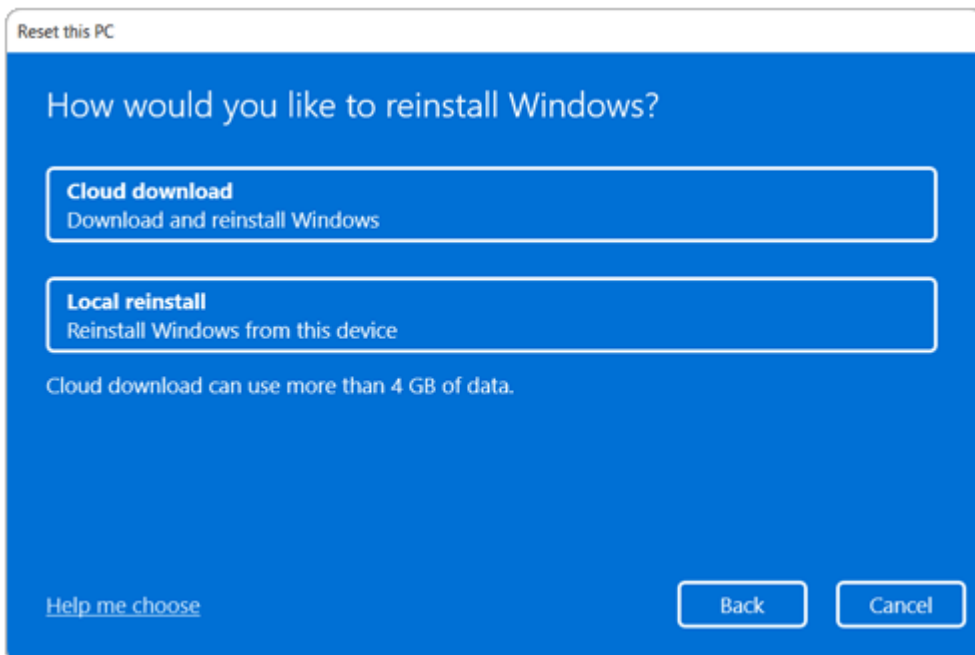

3. Check the current settings and select [Next] to perform the recovery according to the instructions.



Tip:

If you select [Change Settings], you can change the current settings.

Reset this PC

Additional settings

Current settings:

- Remove apps and files. Do not clean the drive
- Delete all files only from Windows drive
- Delete provisioning packages from your workplace
- Download and reinstall Windows

[Change settings](#)

Cloud download can use more than 4 GB of data.

[Learn more about reset this PC](#)

Back

Next

Cancel

Setup and Upgrade

Installing the Driver

You can use LG Update & Renew to install the deleted drivers or the latest drivers easily and quickly.

1. Select the Start button [] > [All] and run [LG Update & Renew].
2. Install a driver in the [Update] menu.

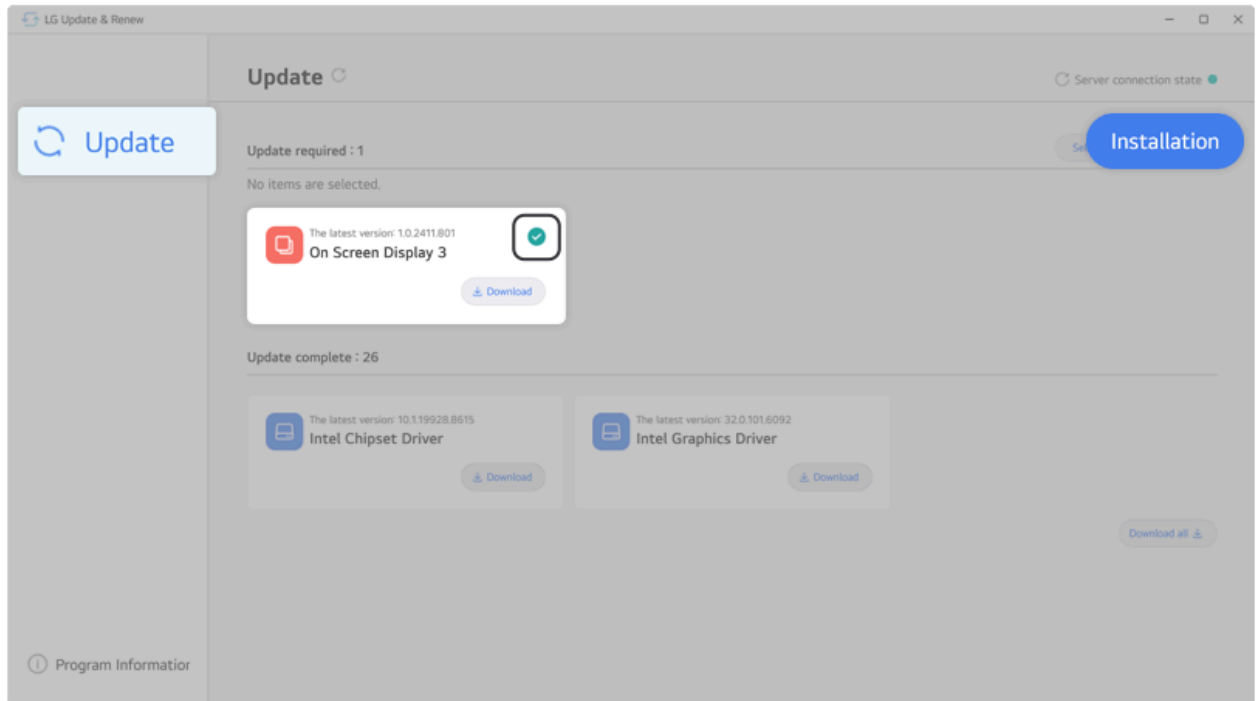

Tip:

Use LG Update & Renew to keep your system current and optimized.
The figures herein are subject to change without prior notice.

How to Download LG Update & Renew

You can download and install LG Update & Renew from LG Electronics website (www.lg.com).

Starting System Setup

System setup means storing the hardware configuration information of the PC in the flash memory. Through system setup, the PC retrieves various information including current date and time, memory capacity, and storage device (HDD, SSD, eMMC) capacity and type.

You setup the system when you set passwords, change the boot order, and add new peripheral devices to the machine.

Items displayed on the Setup screen may differ by model type and specification.



Tip:

To use the system setup (F2), booting device selection (F10), you need to restart the system (click [Restart] in the system power menu) and then immediately press the corresponding function key due to the fast booting speed.



Caution:

- Do not change the system setup unless necessary. Incorrect system setup may cause errors during system operation. Use caution when changing the system setup.
- For performance improvement, the system setup menu configuration and the initial setup status may be changed and may become different from images included in the user manual.

1. Reboot the system and press [F2] multiple times.



2. In a few moments, the system setup screen appears.

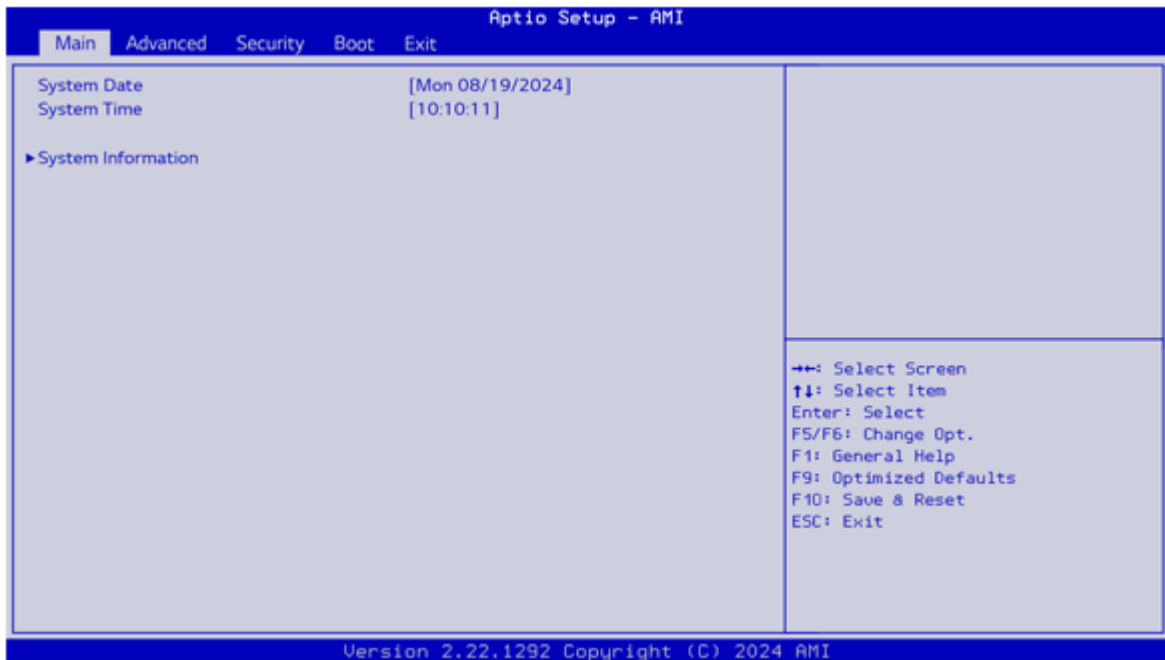

Keys Used in System Setup

Keys	Function
Enter	Selects the current item.
Esc	To deselect the current item or to move to the previous screen.
▲, ▼, ◀, ▶ (Arrow keys)	Moves the cursor up, down, left, and right.
F5, F6	Increases or decreases the item value.
F10	Saves the new settings or exits the system setup.

Setting the Boot Password

This process is to set a password so that other people cannot use the computer or change the settings.

The user can set a password while booting the system or setting up the system.

The model in the example can differ from actual models and is subject to change for performance improvements, without prior notice.



Caution:

Without the registered password, access to the system will be denied. Write down and keep the password in a safe place.

Setting the Supervisor Password

The password prevents unauthorized people from accessing the PC. By default, no password is set for the machine. If an unauthorized person changes the password in the System Setup, you will be unable to access the system.

Tip:

With the Supervisor Password, you are authorized to set all items in the System Setup and to set [Password on boot]. In case other people also use the computer, it is recommended to set the User Password.

1. Reboot the system and press [F2] multiple times.



2. When the System Setup screen appears, go to [Security] > [Set Supervisor Password] using the arrow keys and press the [Enter] key.



3. When the Password Setting screen appears, enter a password and press the [Enter] key.

The password should not exceed 20 characters and should consist of English letters (A - Z), numbers (0 - 9), and special characters or a combination of them.



4. Enter the password once more and press the [Enter] key.



5. To save the changes in system setup, press [F10]. When a pop-up window appears, select [Yes] and press the [Enter] key.

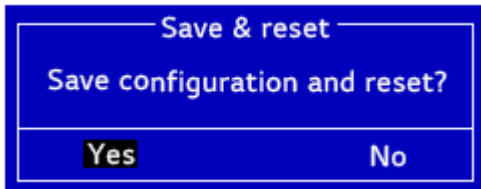

6. The PC will restart.

Setting the User Password

The User Password is lower than the Supervisor Password, so it can be entered only after setting the Supervisor Password.



Tip:

The User Password allows only limited access to the items that can be set compared to the Supervisor Password when using the System Setup.

1. Execute the System Setup screen, go to [Security] > [Set User Password] using the arrow keys and press the [Enter] key.

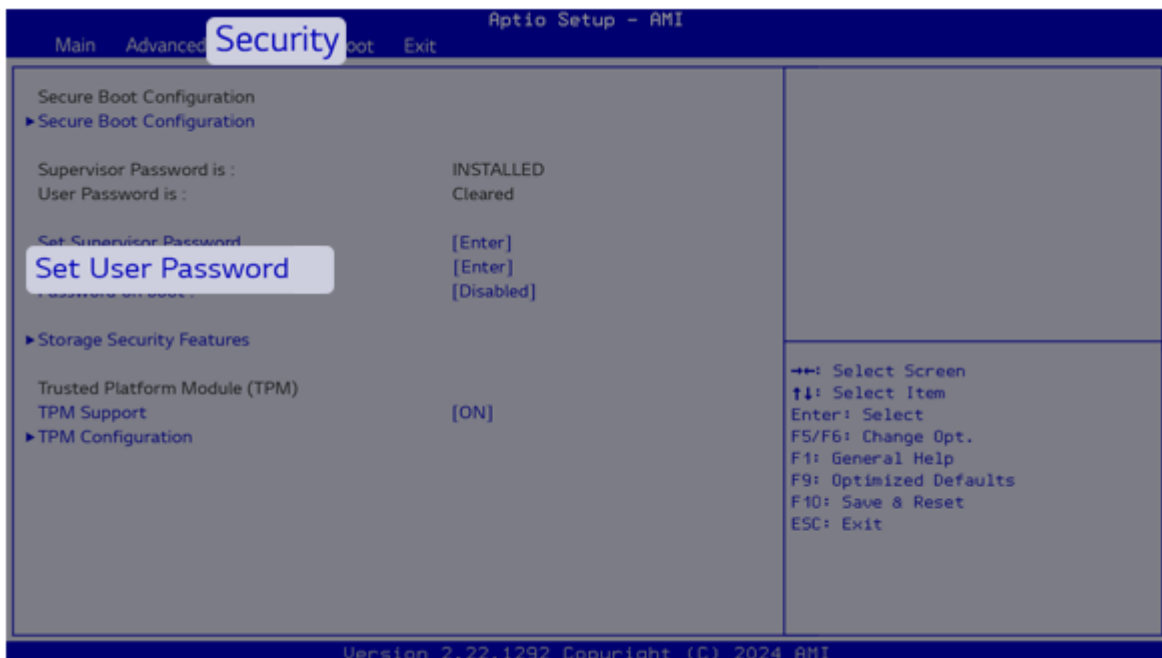

2. When the Password Setting screen appears, enter a password and press the [Enter] key.

The password should not exceed 20 characters and should consist of English letters (A - Z), numbers (0 - 9), and special characters or a combination of them.



3. Enter the password once more and press the [Enter] key.



4. To save the changes in system setup, press [F10]. When a pop-up window appears, select [Yes] and press the [Enter] key.

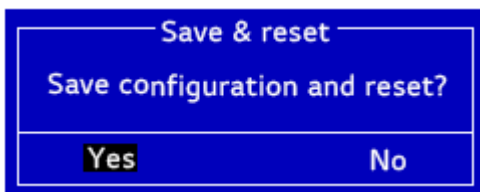

5. The PC will restart.

Password on boot

[Password on boot] protects your system by requiring during booting to enter the Supervisor Password or User Password.

To set [Password on boot], you first need to set the Supervisor Password or set both Supervisor and User Passwords.

1. Execute the System Setup screen, go to [Security] > [Password on boot] using the arrow keys and press the [Enter] key.

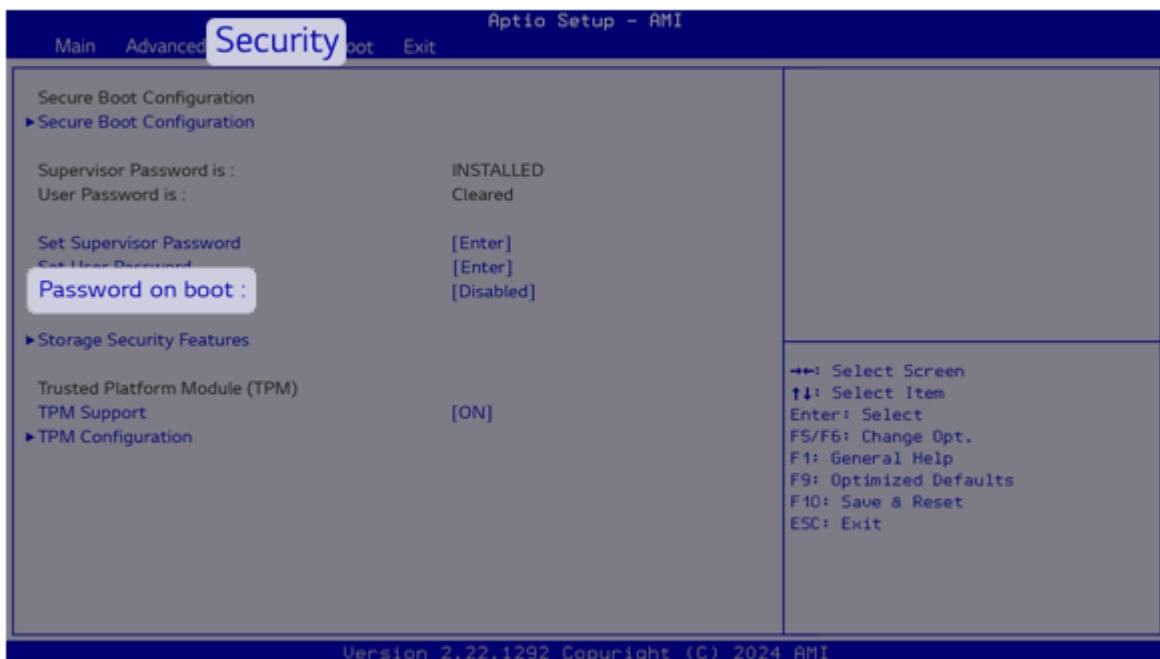

2. Select [Enabled] and press the [Enter] key to complete the [Password on boot] setting.

Setting the Storage Device Password

The Storage Device Password is to set a password in the storage device separate from the Supervisor Password.



Tip:

- Some storage devices may not support password setting.
- For the models equipped with two storage devices, you can set a password for each device. If passwords are set for both devices, the password input window appears twice during the booting process. The order in which the password input windows appears is according to the [Boot Type Order] of the [Boot] menu.



Caution:

If you lose the password for a storage device, you cannot recover the storage device.

- Please note that replacement of a storage device due to the loss of the password of the storage device is excluded from the product warranty.

1. Execute the System Setup screen, go to [Security] > [Storage Security Features] using the arrow keys and press the [Enter] key.

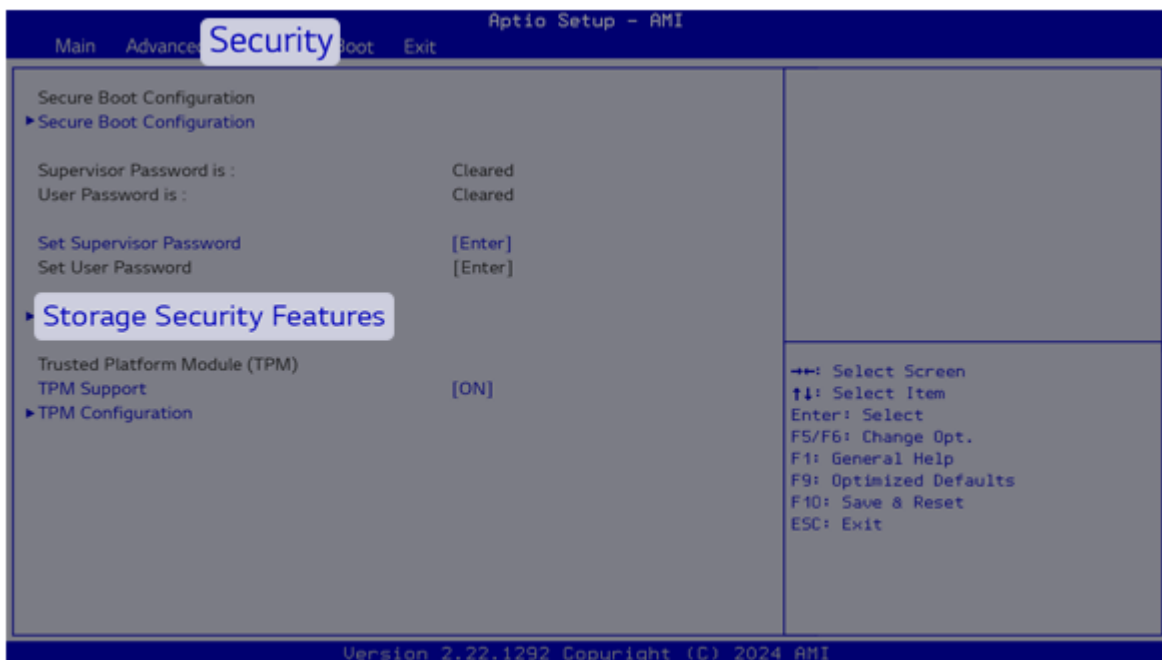

2. Go to the desired device and press the [Enter] key.



3. Press the [Enter] key in [Set Password].
4. When the Password Setting screen appears, enter a password and press the [Enter] key.
The password should not exceed 32 characters and should consist of English letters (A - Z), numbers (0 - 9), and special characters or a combination of them.



5. Enter the password once more and press the [Enter] key.



6. To save the changes in system setup, press [F10]. When a pop-up window appears, select [Yes] and press the [Enter] key.

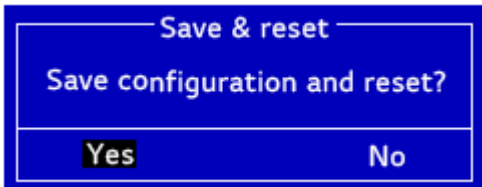

7. The PC will restart.

Deleting/Changing the Boot Password

You can delete or change the password only after entering the current password.

The model in the example can differ from actual models and is subject to change for performance improvements, without prior notice.

Changing the Boot Password

1. Execute the System Setup screen, enter the password, and press the [Enter] key.



2. Change the password in the same way as setting one.

Deleting the Boot Password

1. Execute the System Setup screen, enter the password, and press the [Enter] key.

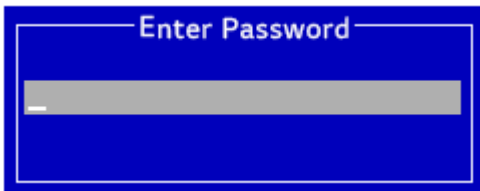

2. When the System Setup screen appears, go to [Security] > [Set Supervisor Password] using the arrow keys and press the [Enter] key.



3. Enter the current password in the [Enter Current Password] field.



4. Press the [Enter] key in the [Create New Password] field.



5. When a pop-up window appears, select [Yes] and press the [Enter] key.

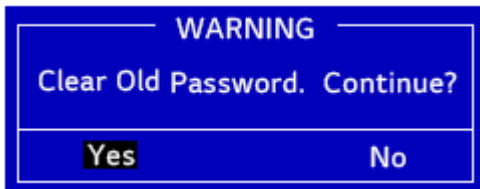

6. To save the changes in system setup, press [F10]. When a pop-up window appears, select [Yes] and press the [Enter] key.

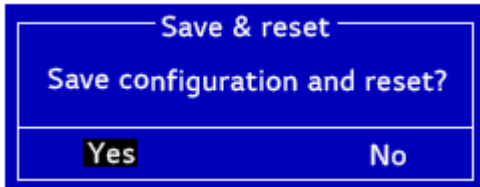

7. The PC will restart.

Deleting the Boot Password (Storage Device)

1. Execute the System Setup screen, enter the password, and press the [Enter] key.

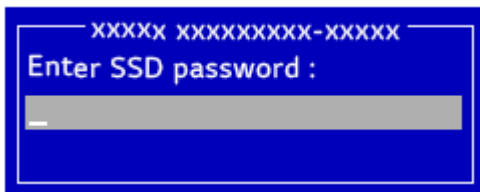

2. When the System Setup screen appears, go to [Security] > [Storage Security Features] using the arrow keys and press the [Enter] key.

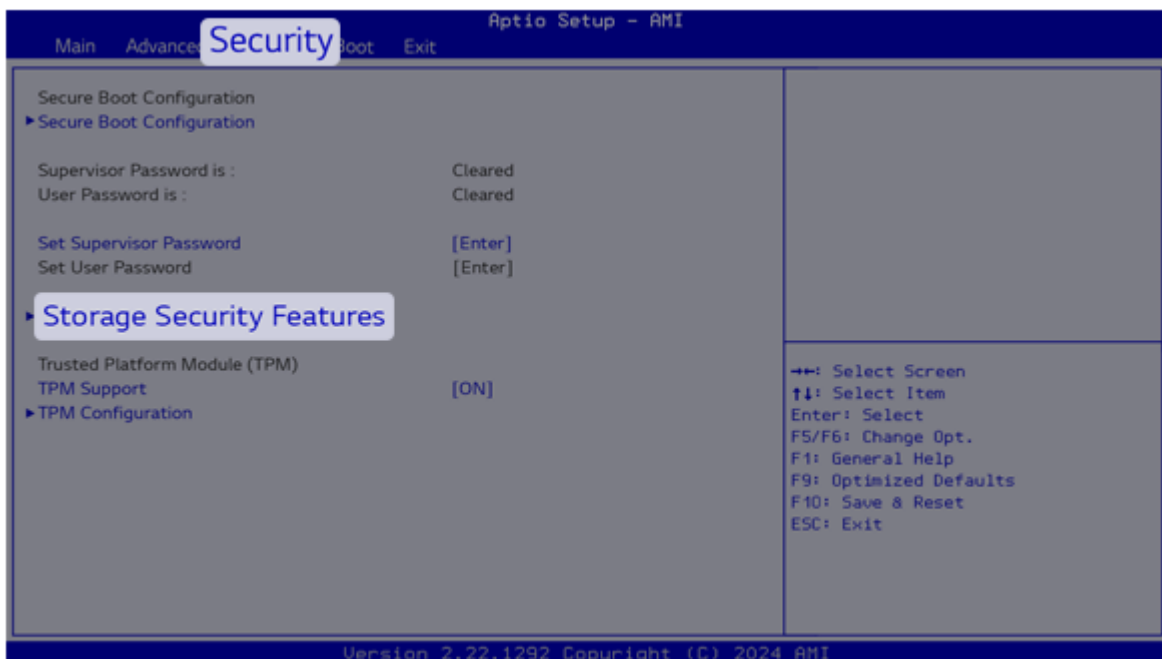

3. Go to the desired device and press the [Enter] key.



4. Press the [Enter] key in [Set Password].
5. Enter the current password in the [Enter Current Password] field.

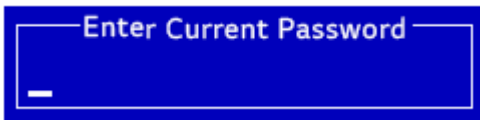

6. Press the [Enter] key in the [Create New Password] field.



7. When a pop-up window appears, select [Yes] and press the [Enter] key.

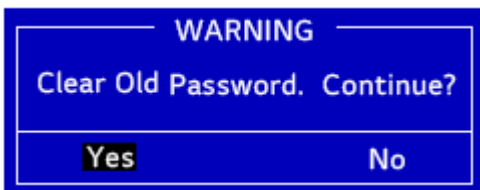

8. To save the changes in system setup, press [F10]. When a pop-up window appears, select [Yes] and press the [Enter] key.

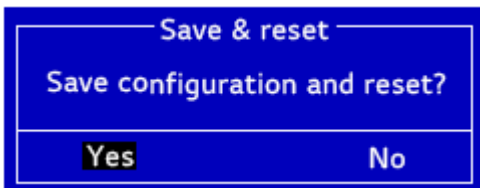

9. The PC will restart.

Initializing System Setup

If you have changed the system setup by mistake, you can restore the default settings.

The model in the example can differ from actual models and is subject to change for performance improvements, without prior notice.

1. Execute the System Setup screen, go to [Exit] > [Load Setup Defaults] using the arrow keys and press the [Enter] key.



Tip:

You can press the [F9] key to use the [Load Setup Defaults] item.

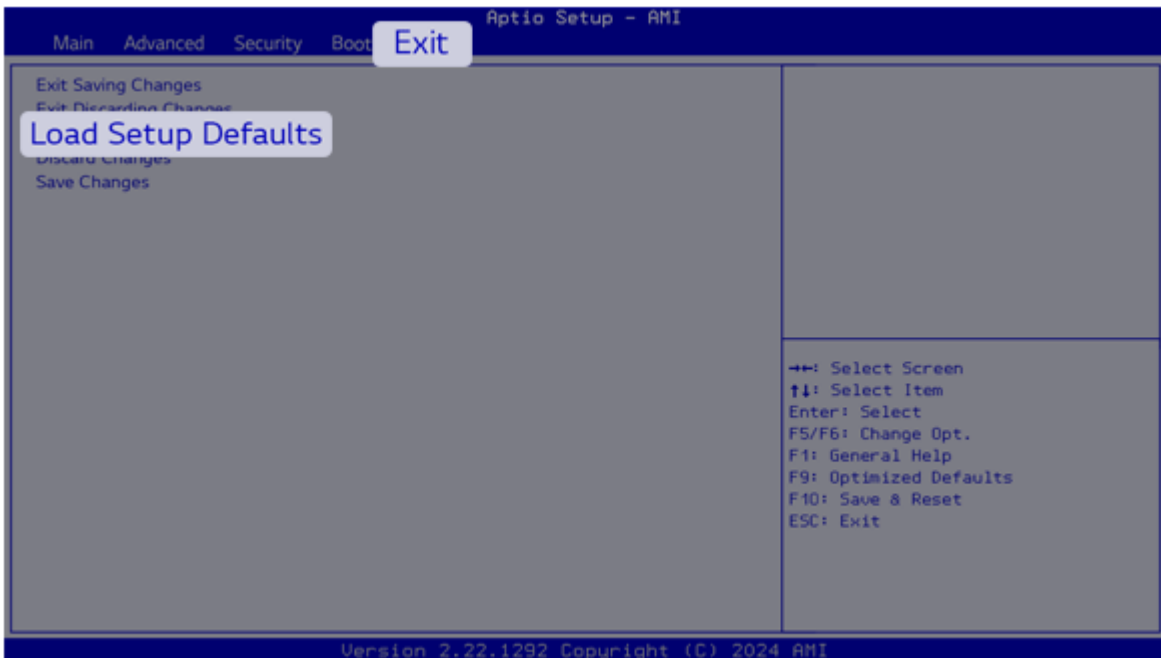

2. When a pop-up window appears, select [Yes] and press the [Enter] key. The settings will be reset to the factory default.

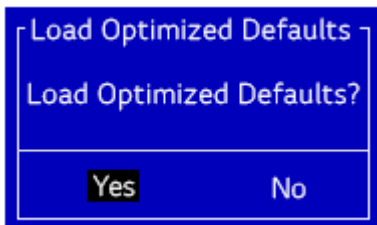

3. To save the changes in system setup, press [F10]. When a pop-up window appears, select [Yes] and press the [Enter] key.

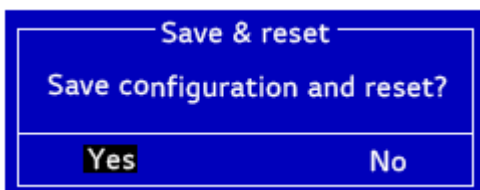

4. The PC will restart.

Changing the Boot Order

The user can change the boot order according to his or her needs, or select a boot device

The model in the example can differ from actual models and is subject to change for performance improvements, without prior notice.



Tip:

To use the system setup (F2), booting device selection (F10), you need to restart the system (click [Restart] in the system power menu) and then immediately press the corresponding function key due to the fast booting speed.

Changing the Boot Order

1. Reboot the system and press [F2] multiple times.



2. Go to the [Boot] menu using the arrow keys when the system setup screen appears.
3. Go to [Boot Type Order] and press [F5] or [F6] to change the booting order.

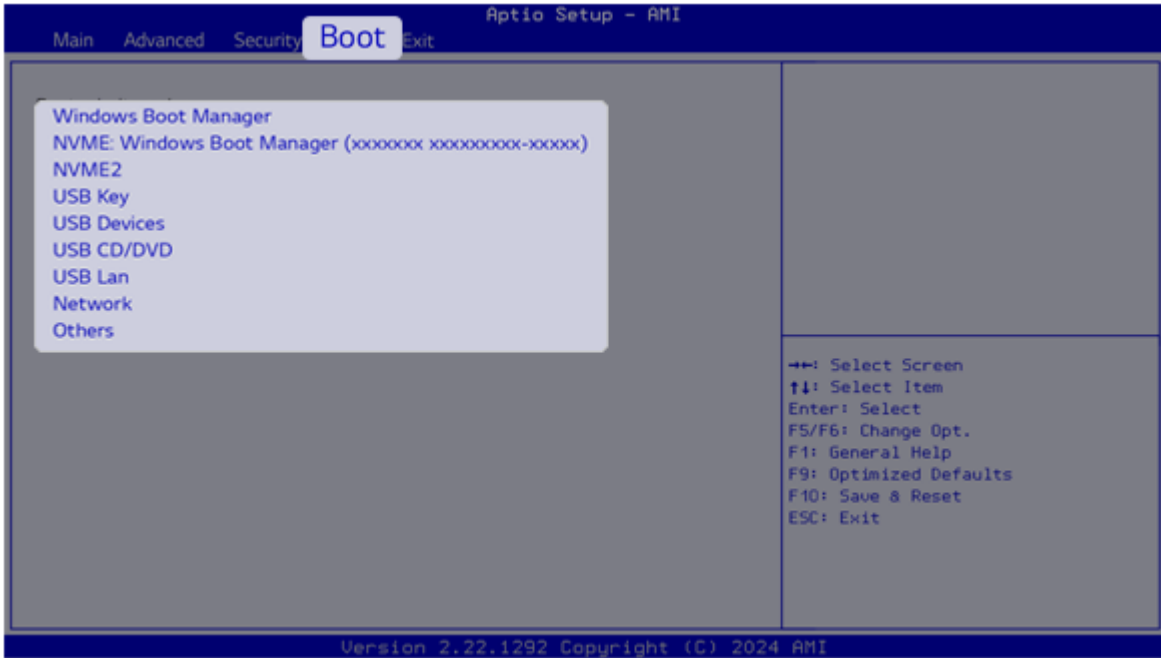

4. To save the changes in system setup, press [F10]. When a pop-up window appears, select [Yes] and press the [Enter] key.

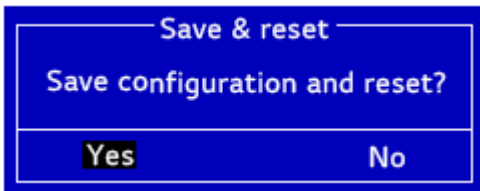

5. The PC will restart.

Selecting a Booting Device to Use

1. Reboot the system and press [F10] multiple times.



- When the Select Boot Device screen appears, go to the desired device using the arrow keys and press the [Enter] key.

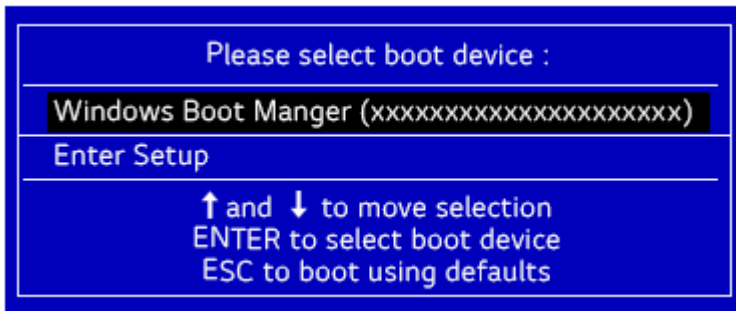

- Boots using the selected device.

Setting Auto Scaling

The Windows Auto Scaling feature for user's convenience may partially blur the screen or display some icons and texts larger.

Refer to the following information to change the DPI scaling to suit your needs.

- Select the Start button [] > [Settings].



Tip:

Press the [] key or [Ctrl] + [Esc] on the keyboard to display the Start screen.

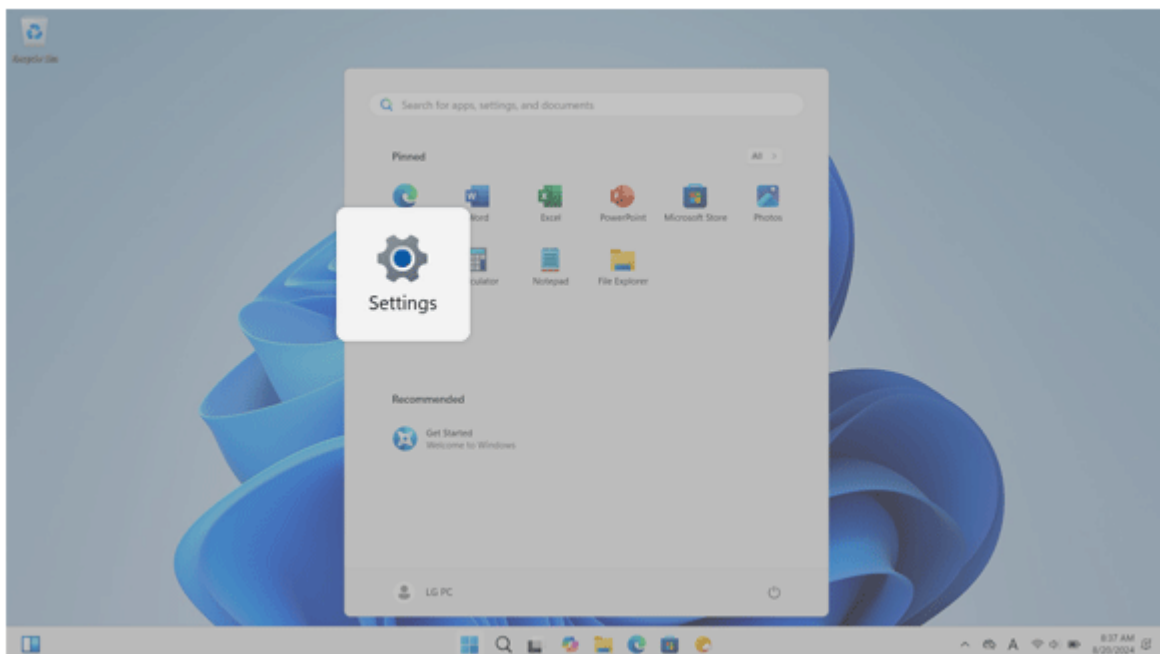

- Select [System] > [Display].
- Changing the [Scale] item value changes the auto scaling settings.

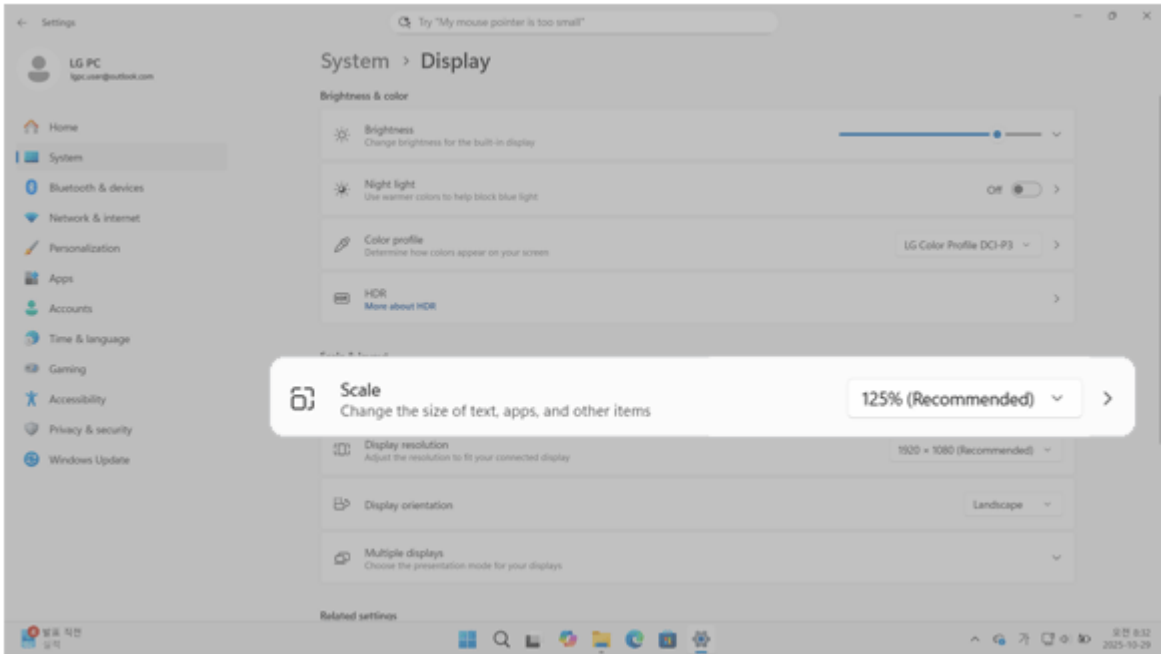

Tip:

After changing the Auto Scaling settings, some apps must be shut down and restarted for the scaling and layout to take effect.

Using Instant Booting

Instant Booting allows the system to boot automatically when the notebook PC cover is opened, so that you can use the system without pressing the power button.

1. Select the Start button [] > [All] and run [My gram].
2. Turn on [Instant Booting].

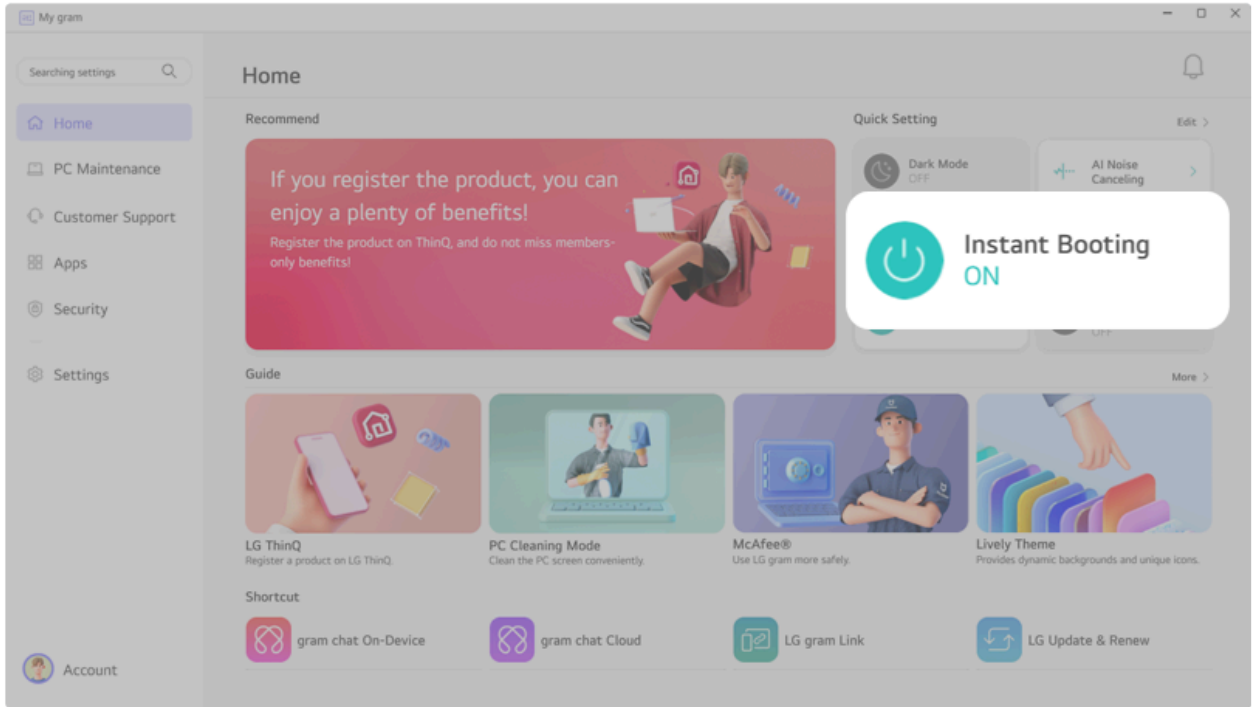

3. Shutdown the system and close the notebook PC cover.

4. When the cover is opened, the notebook PC turns on and the system starts to boot automatically.

FAQ

Using USB-C® Charging Function

You can connect the USB-C® device to charge a notebook PC battery or an external device, and the operation mode is automatically selected depending the charge settings of the connected device.

- To charge a notebook PC battery, the external device (USB PD Charger, notebook PC, etc.) should support USB Power Delivery 10 W (5 V / 2 A) or higher profile.
- The external devices that use the USB-C® port support 10 W (5 V / 2 A) and 15 W (5 V / 3 A).
- A USB device compatible with USB PD (Power Delivery) supports charging at 15 W (5 V / 3 A), whereas a regular USB device supports charging at 10 W (5 V / 2 A). If you use two USB-C® ports simultaneously, each port supports charging at 7.5 W (5 V / 1.5 A).
- USB PD batteries cannot be charged using the USB-C® port of the notebook PC.
- Always-On Charging is supported only with USB-C® ports, but not with the regular USB ports.
- If you connect an adapter with a lower output than the rated adapter, it may take more time to charge the notebook PC.
 1. When the connected device is set to Automatic (charging the notebook PC or a connected device. Charging the notebook PC by using the mobile phone is not supported.)



2. When the connected device is set to Source (the notebook PC is charged.)



3. When the connected device is set to Sink (the connected device is charged.)



Tip:

The charging status of the external device being charged is not displayed on the notebook PC.

If you connected a smartphone, you should select "Charge mobile phone" on the smartphone screen to charge the phone battery.



Caution:

If the power consumption of the notebook PC is larger than the power supply from the external device, the battery may be consumed gradually.

My gram

My gram suggests an optimal environment customized to a user's PC status, and helps experience various apps provided by LG.

- Select the Start button [] > [All] and run [My gram].
 - Press the [Fn] + [F1] keys to start the app easily.

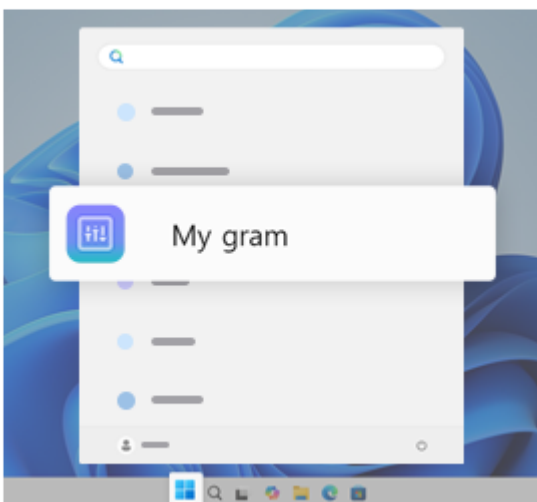

Tip:

The menus and functions displayed in this app may differ depending on the model and app version.

You can re-install the app in LG Update & Renew.



The figures herein are subject to change without prior notice.

Tour

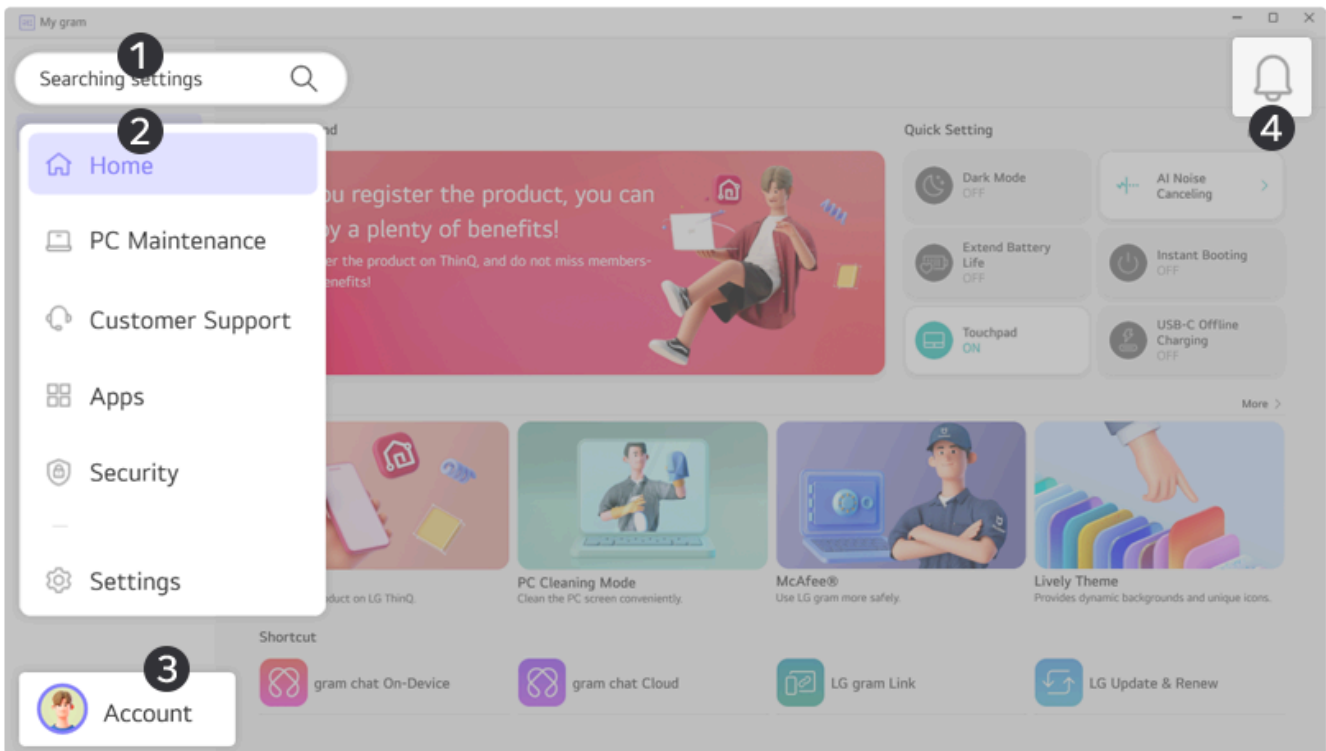

1. Search

You can search and use various settings.

2. Home

The user can receive customized settings depending on your PC status, or set main PC functions easily.

[Learn more >](#)

PC Maintenance

The user can easily change and use various PC functions according to his or her needs.

[Learn more >](#)

Customer Support

Notifies you of the apps or convenient functions provided by LG.

Apps

You can run the apps provided by LG directly.

Security

You can set the function to enhance PC security.

[Learn more >](#)

Settings

You can check app information or use the lab.

3. Account

You can register your PC on your LG ThinQ account.

4. Notification

Notifies the user of important information and updates.

Home

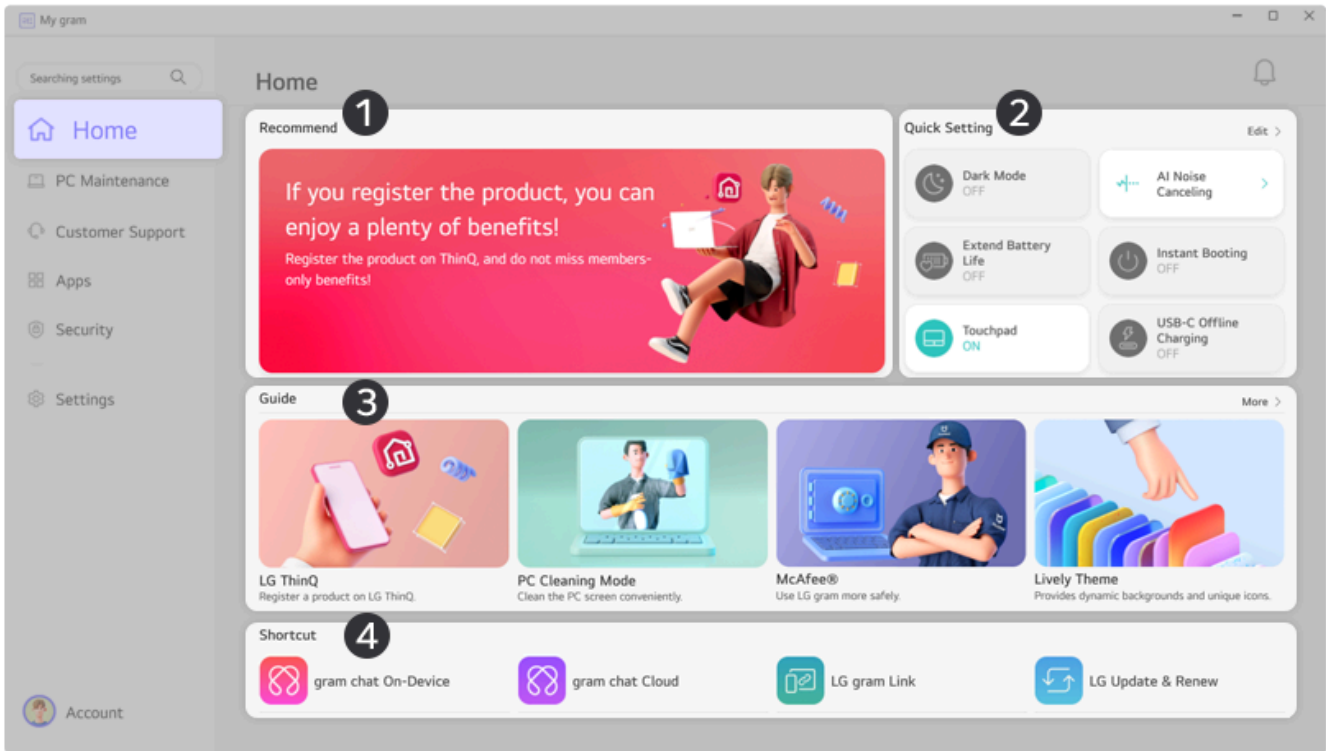

1. **Recommend:** Suggests customized settings according to the user's PC status and provides related links.
2. **Quick Setting:** Allows you to set main PC functions easily. Items can be changed and up to 6 items can be added.
3. **Guide:** Notifies you of the apps or convenient functions provided by LG.
4. **Shortcut:** You can run the apps or websites provided by LG directly.

PC Maintenance

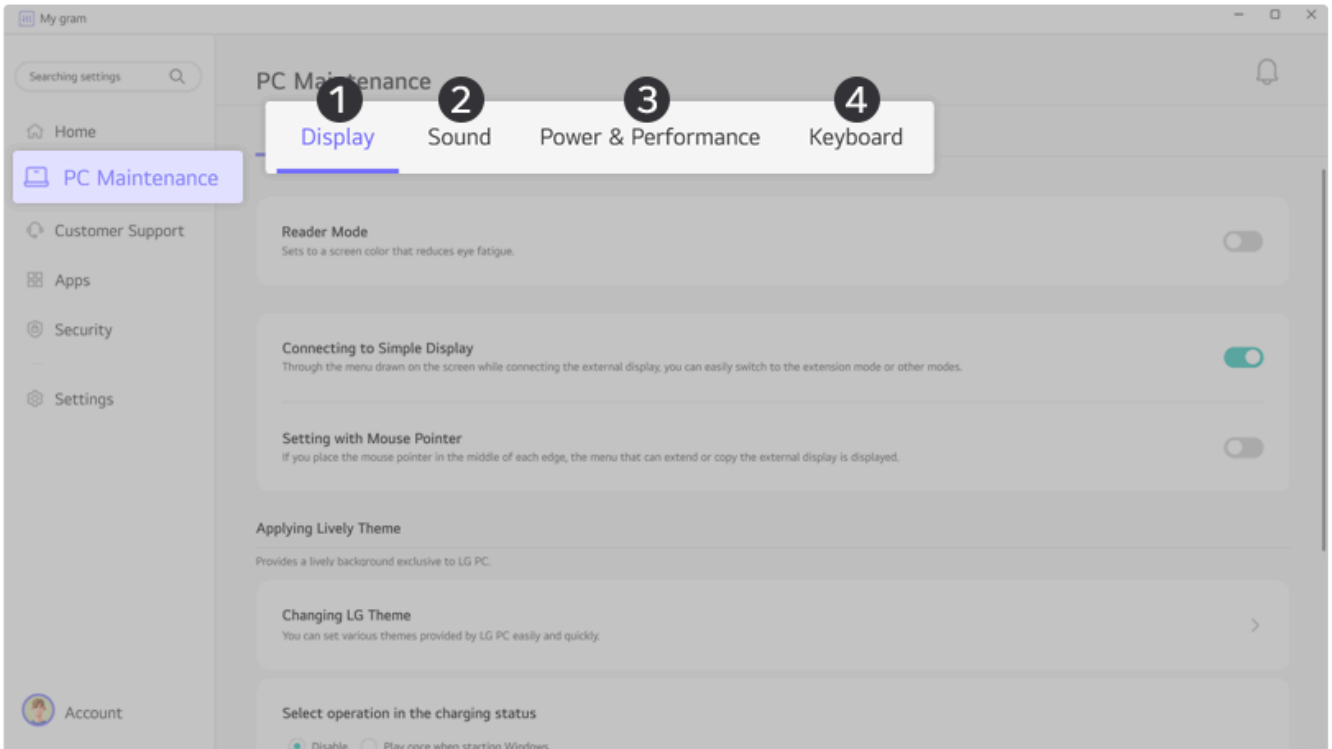

1. Display

Function	Description
Reader Mode	<p>Allows you to set the Reader Mode to reduce eye fatigue when reading documents.</p> <ul style="list-style-type: none"> Using the Reader Mode and the Night light at the same time can cause color distortion. When you use the Reader Mode, turn off the Night light. <p>You can turn [Night Mode] on or off in the Start button [Windows Logo] > [Settings] > [System] > [Display].</p>
Connecting to Simple Display	When connecting an external display, you can set to display the menu that can set the Display Mode on the PC screen.
Applying Lively Theme	You can set various themes provided by LG PC or select an operation method of Lively Theme according to the charging status.

2. Sound

*Supported to the built-in microphone/speaker only.

Function	Description
AI Microphone Optimization	Cancels out the noise input to the microphone to deliver clear sound.
AI Speaker Optimization	Cancels the noise output from the speakers to deliver clear sound.

User voice tracking	It removes voices of other users in the surroundings and delivers the registered user's voice only. It can be used in the Uni Directional Noise Canceling mode only.
---------------------	--

3. Power & Performance

Function	Description
Cooling Mode	Allows you to set the fan mode of the PC according to the PC environment. Learn more >
Battery Life Status	Displays the battery status so that you can replace the battery timely.
Extend Battery Life	Allows you to lower the battery charge completion level to 80%, or set to extend the battery life through the AI mode that learned the user pattern and PC status.
Turning off the screen by detecting AFK	Allows you to set to turn off the screen automatically by detecting AFK with a camera.
USB-C® Offline Charging	Allows you to set the PC to charge external devices via the USB-C® port even when the PC is turned off.
Battery Saving Mode	You can adjust some of the PC's settings, such as the Power mode, screen and sleep settings, keyboard backlight, display brightness, and Windows Auto Update, to use the battery for a longer duration. (This applies only when the PC adaptor is not connected to the power.)
AI Battery Usage Detection Notification	You can set the PC to use its AI analysis function and alert you when multiple applications or vaccine programs that consume the battery a lot are being used.

4. Keyboard

Function	Description
Keyboard Backlight	You can set whether to use keyboard backlight and brightness, and can set the keyboard backlight to turn off automatically after the designated time.
Lock Fn Key	Allows you to set the hot keys (F1 - F12) to operate even without pressing Fn.
Shortcut Guide	While pressing and holding the [Fn] key, you can set to display the shortcut guide that can be combined with this key.
Display NumLock Key Status	Allows you to set the screen to display the status change when you press the NumLock key.

Display CapsLock Key Status Allows you to set the screen to display the status change when you press the CapsLock key.

Shortcut Settings You can register the app or Internet address to set to use as a shortcut, or check the designated shortcut.

[Learn more >](#)

[Cooling Mode Guide]

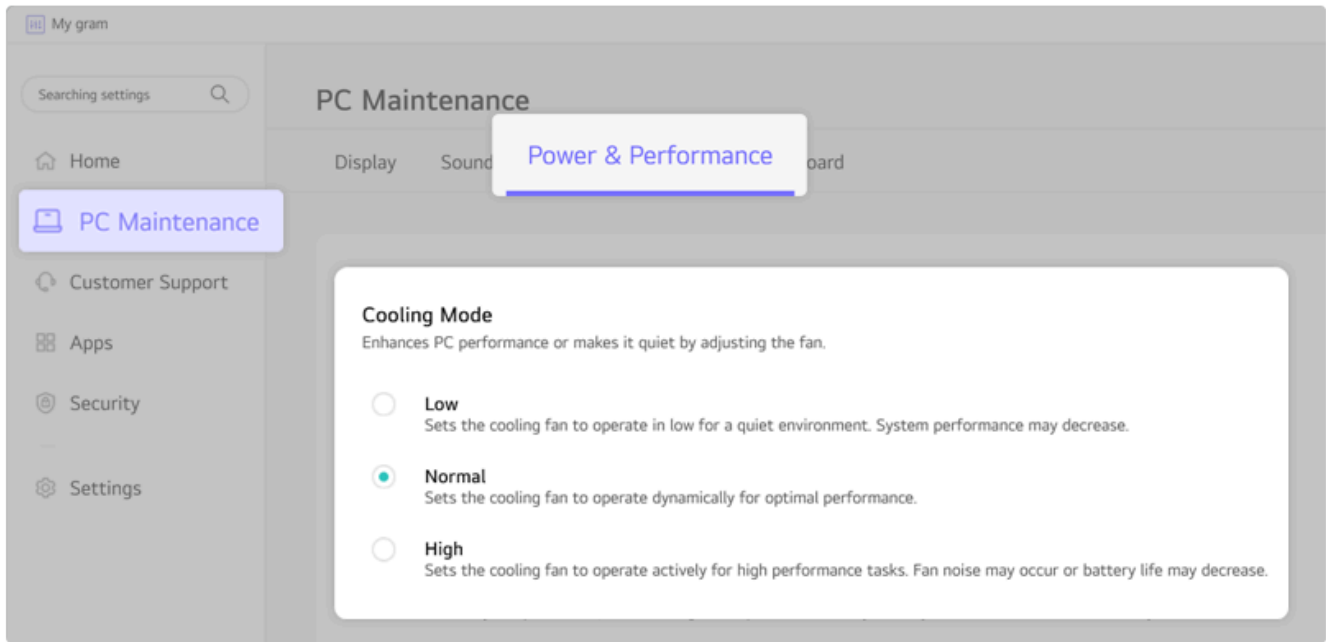

- **Low:** Minimizes fan speed so that you can use the PC in a quiet environment. (This may degrade your PC performance.)
- **Normal:** Optimizes PC performance, heat and noise.
- **High:** Sets to the tasks that require high performance. (This may result in increased PC surface temperature and noise, and shorter battery life.)





Caution:

When using for a long term, use Normal Mode.

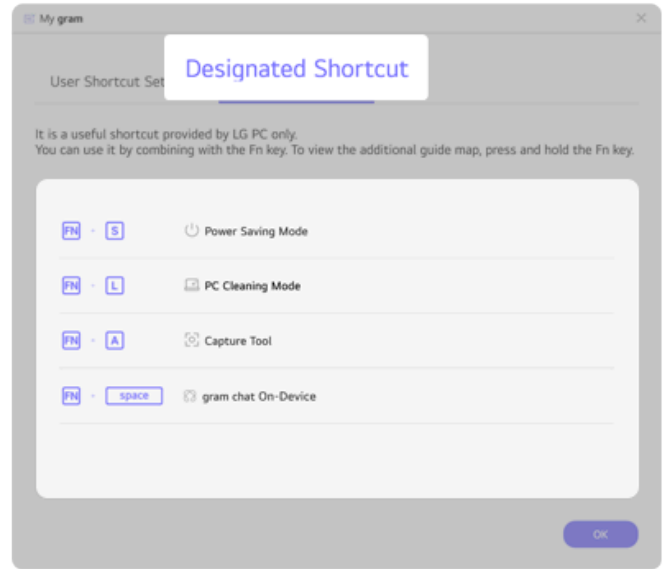
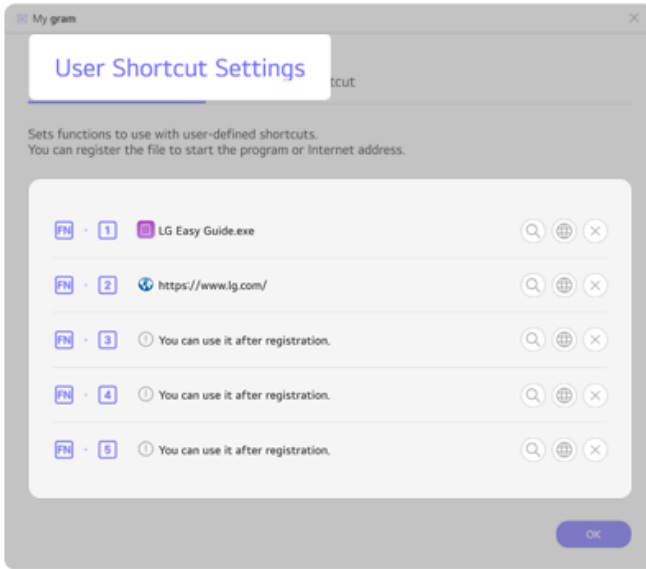
[Shortcut Setting Guide]



- **User Shortcut Settings:** On the Shortcut Settings List, select the navigation icon [] or the internet icon [] to register the desired app or Internet address to a shortcut.

 Tip:

Some abnormal program files (exes) and Internet addresses (links) may not be linked.

Shortcuts can be set from 1 to 5.

After selecting the app-running file, right-click the mouse and use the [Show more options] > [Set functions to use with user Hot keys] menu to register the app quickly.

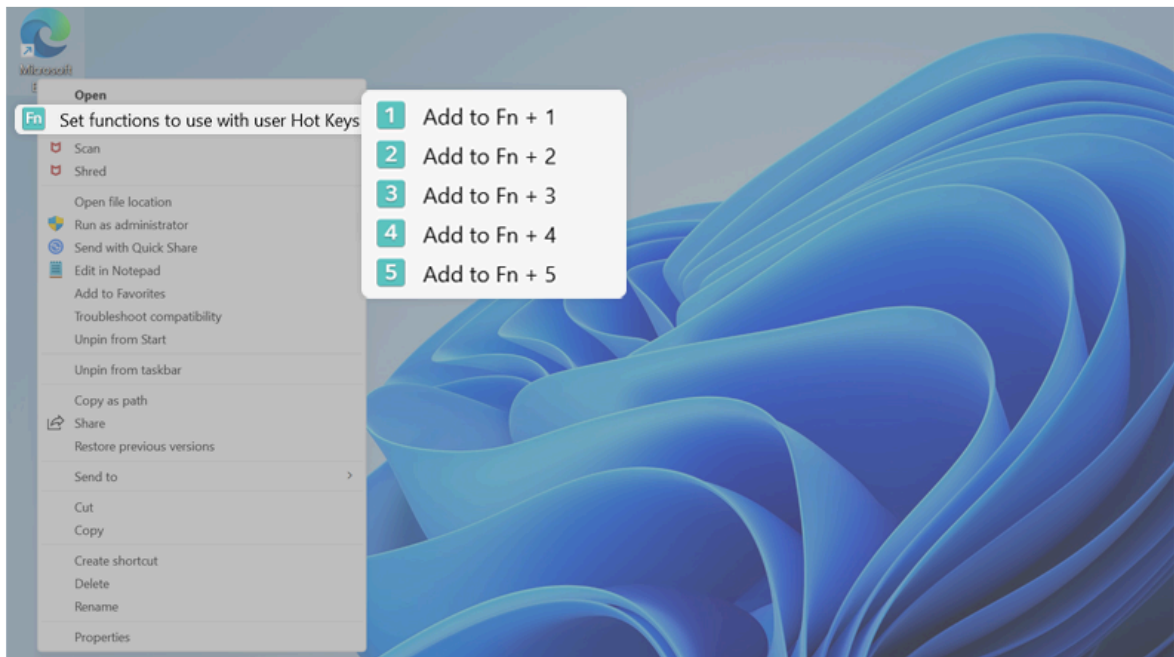

- **Designated Shortcut:** The Fn key can be combined with shortcuts supported only by LG PC to use some functions easily, and the designated shortcuts may not be changed by the user.

 Tip:

The PC Cleaning Mode is a function that locks the keyboard, touchpad, and touch screen to stop operating when cleaning the product while the power is turned on. (The touch screen lock function applies only to the model with the touch screen provided.)

Turn off PC Cleaning Mode: Press and hold the [Fn] + [L] keys on the keyboard until the bar displayed on the screen is filled.



 Caution:

Do not clean using liquid or solution while the power is turned on.

- A malfunction or fire may occur.

Security

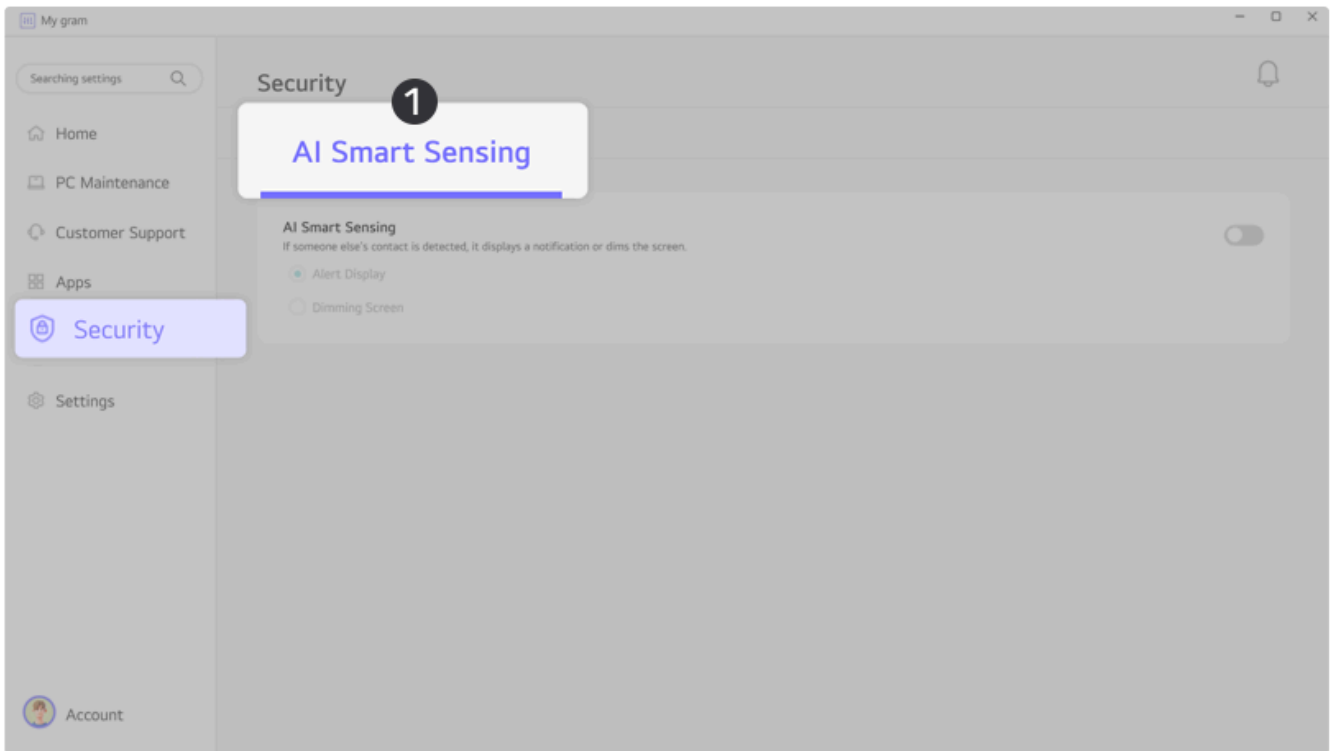

1. **AI Smart Sensing:** Notifies the user of detection of someone else's contact by using the AI-based contact detection function.

Restoring the System

If the system has an error, you can use Windows' recovery function to recover or restore the system to its initial pre-purchase state.

Caution:

If you have deleted the restoration data in the protected area of the disk, or have arbitrarily installed another operating system, the restore function may not work.

To recover the system, the adapter must be connected.

1. Select the Start button [] > [Settings].

Tip:

Press the [] key or [Ctrl] + [Esc] on the keyboard to display the Start screen.

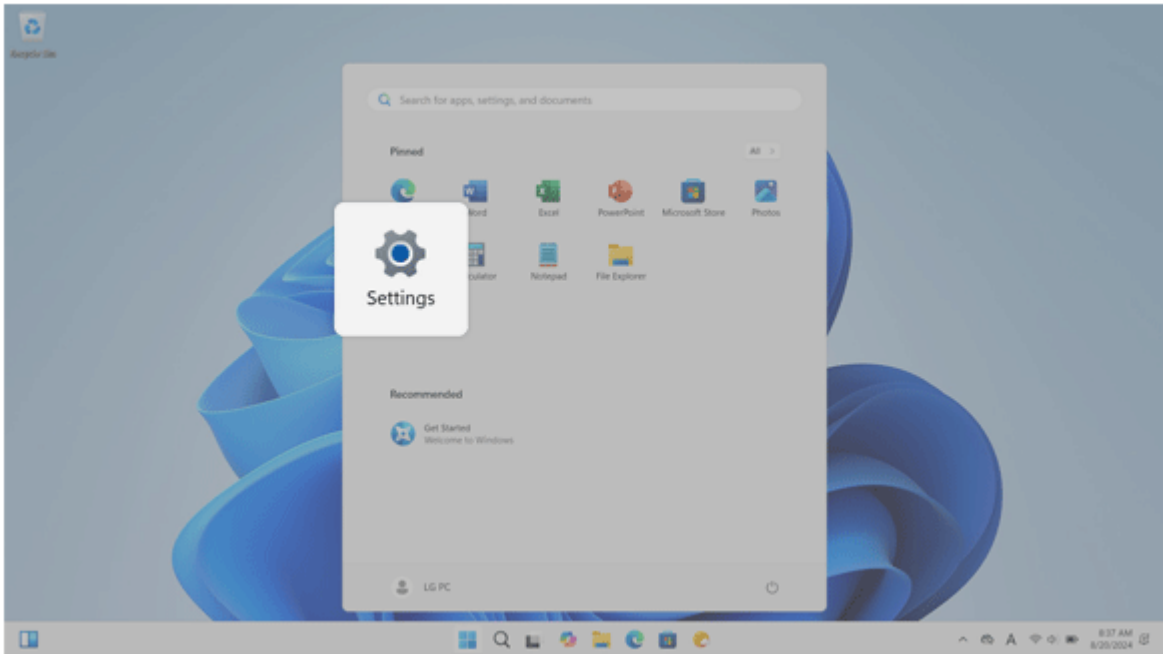

2. Select [Reset PC] in [System] > [Recovery] > [Reset this PC].

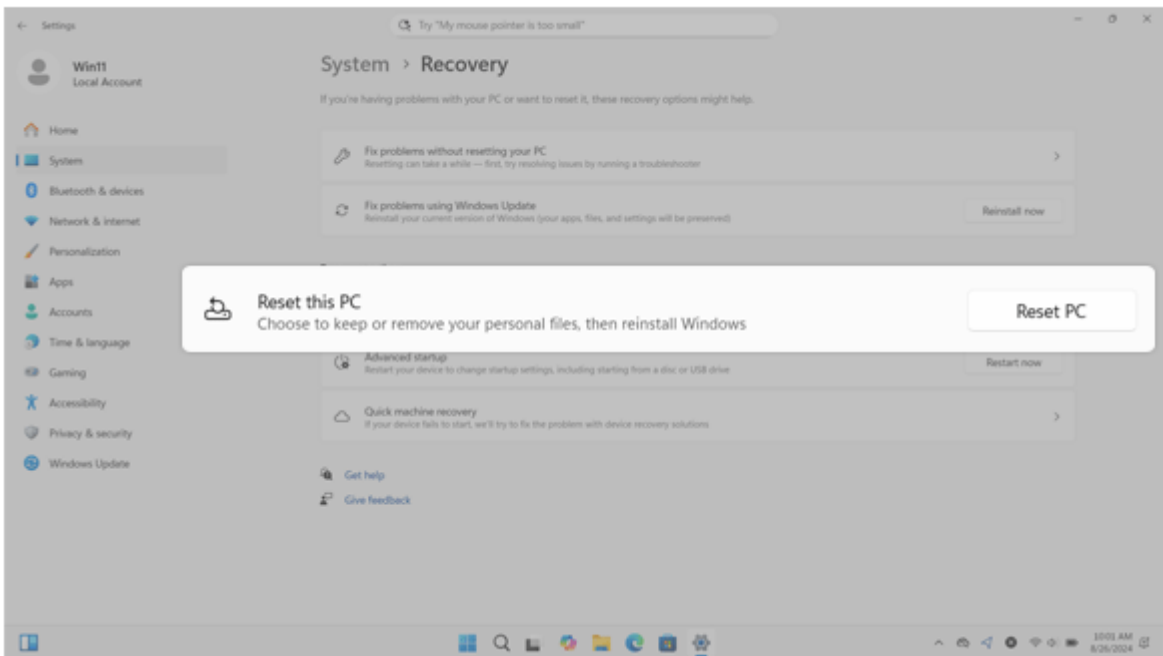

3. Select the options you want to proceed with the recovery.

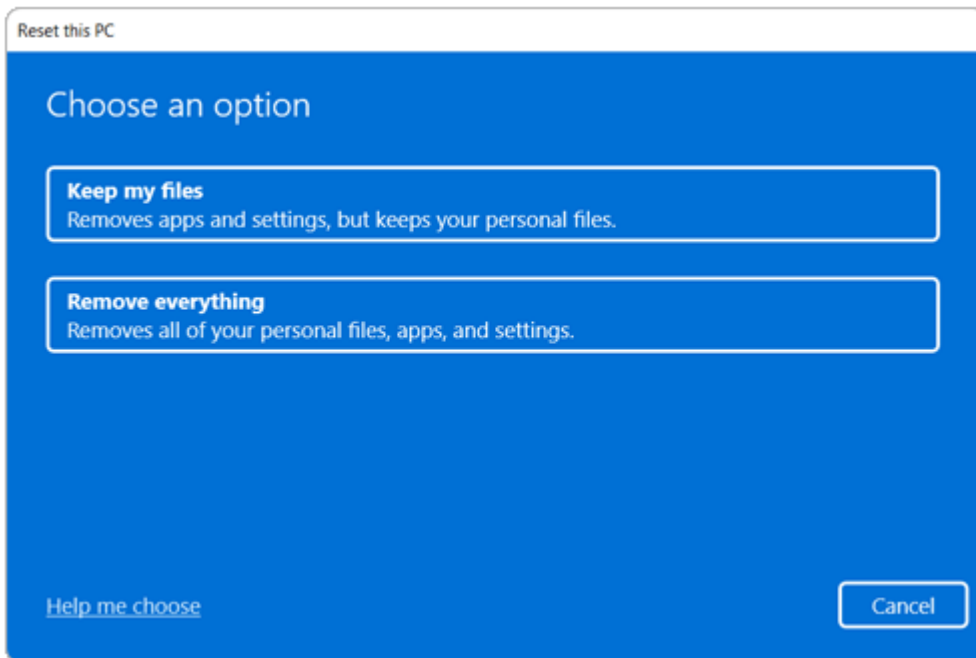

Keep My Files

It removes the apps and their settings without loss of personal files.

1. Select [Keep my files].

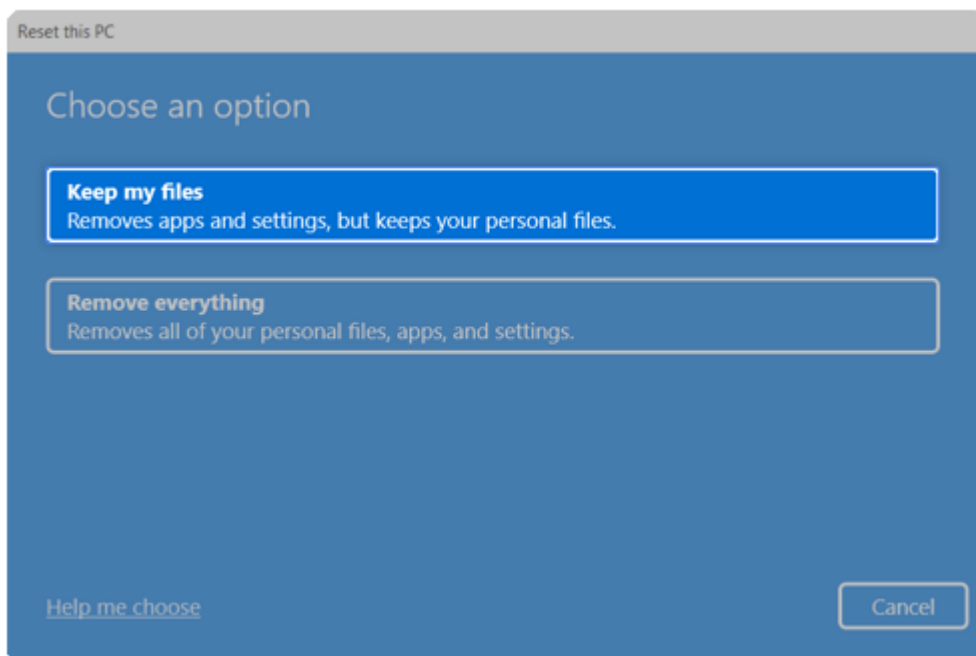

2. Select How to Reinstall Windows.



Tip:

If the PC is not connected to the Internet, the screen for selecting Windows installation method does not appear.

[Cloud download] is a menu for downloading Windows from Microsoft Cloud Server and reinstalling it.



The required time may vary depending on the Internet speed.

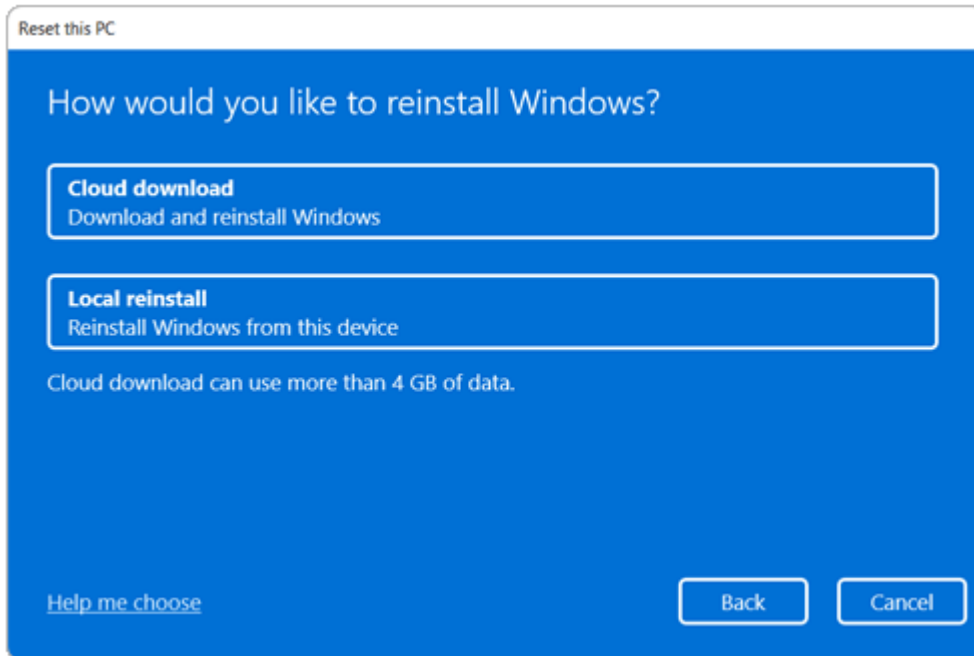

3. Check the current settings and select [Next] to perform the recovery according to the instructions.



Tip:

If you select [Change Settings], you can change the current settings.

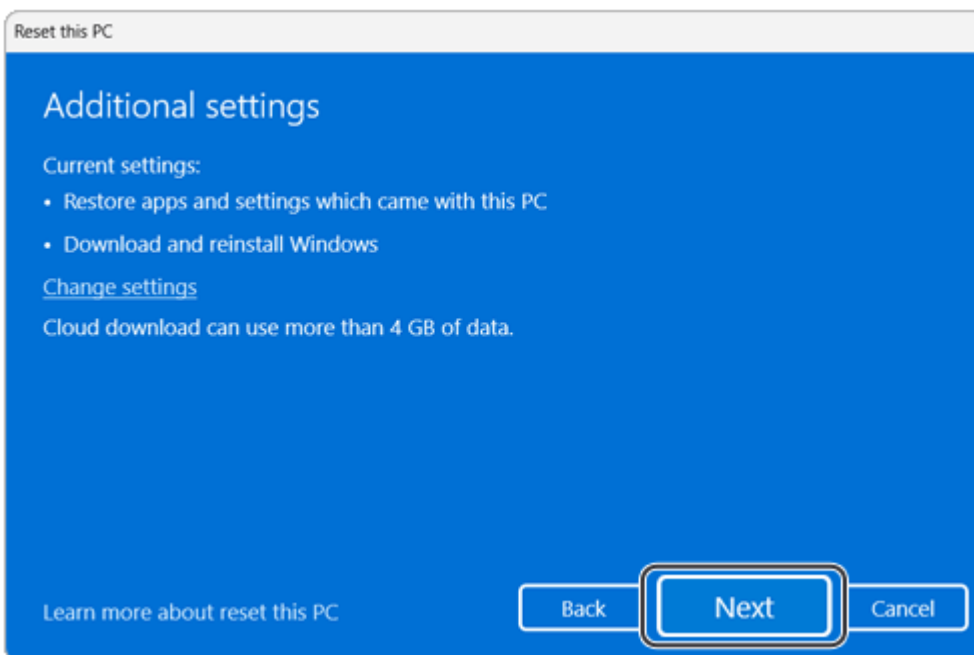

Remove everything

Removes all items from the system and restores the system to its initial pre-purchase state.



Caution:

All data is lost during the initialization, so you must backup all critical data in advance.
It may take about 5 hours or longer depending on the system conditions.

1. Select [Remove everything].

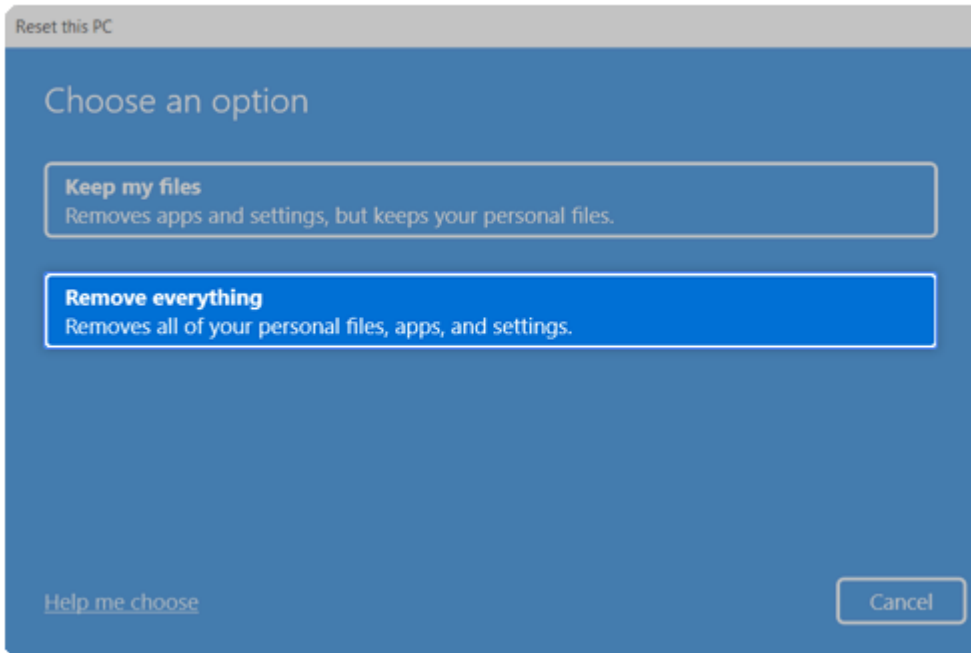

2. Select How to Reinstall Windows.



Tip:

If the PC is not connected to the Internet, the screen for selecting Windows installation method does not appear.

[Cloud download] is a menu for downloading Windows from Microsoft Cloud Server and reinstalling it.

The required time may vary depending on the Internet speed.

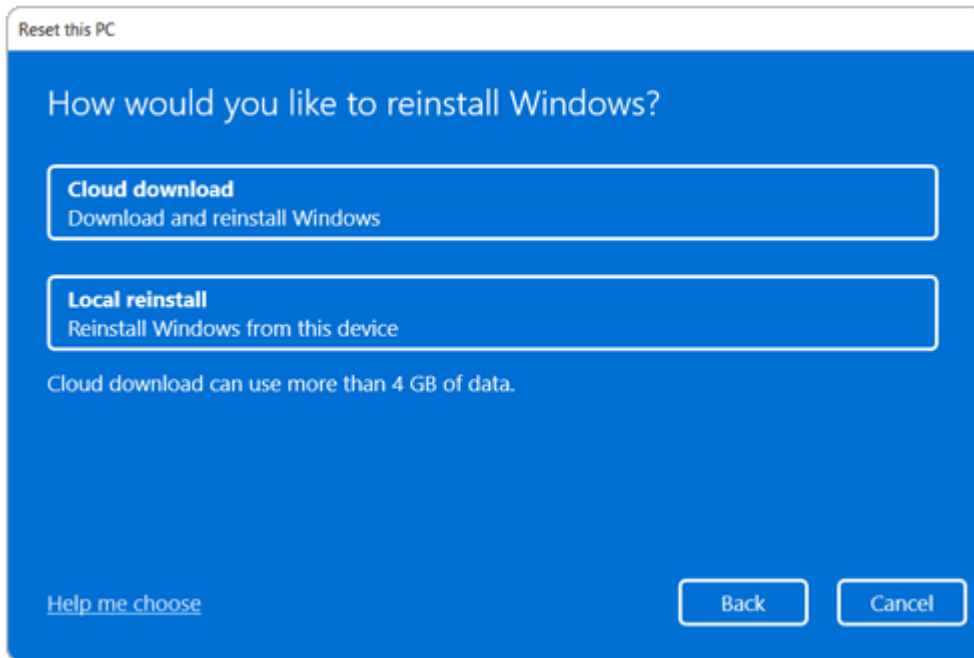

3. Check the current settings and select [Next] to perform the recovery according to the instructions.



Tip:

If you select [Change Settings], you can change the current settings.

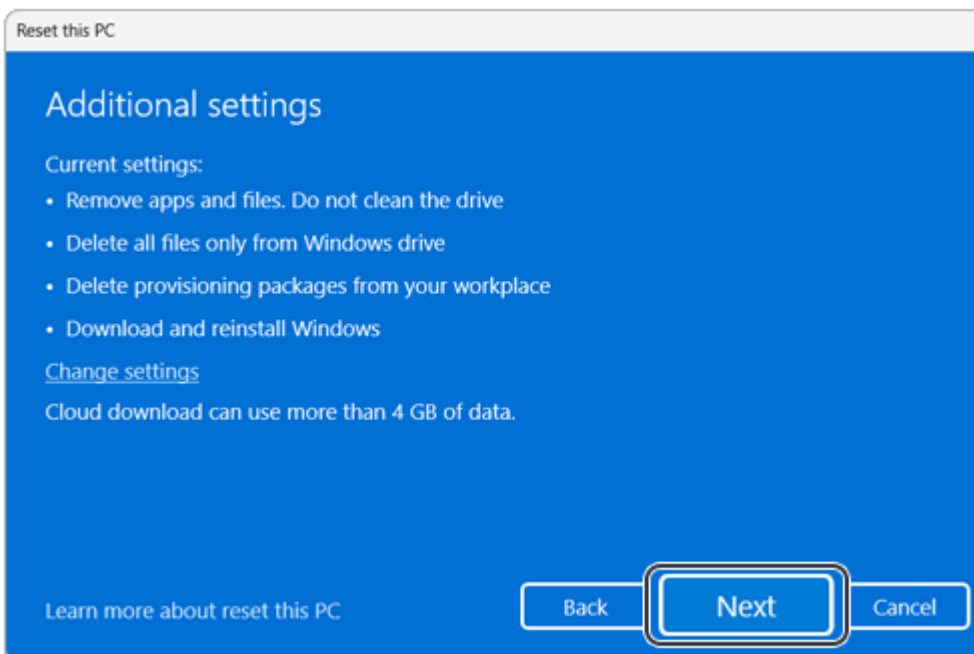

Setting the Boot Password

This process is to set a password so that other people cannot use the computer or change the settings.

The user can set a password while booting the system or setting up the system.

The model in the example can differ from actual models and is subject to change for performance improvements, without prior notice.



Caution:

Without the registered password, access to the system will be denied. Write down and keep the password in a safe place.

Setting the Supervisor Password

The password prevents unauthorized people from accessing the PC. By default, no password is set for the machine. If an unauthorized person changes the password in the System Setup, you will be unable to access the system.



Tip:

With the Supervisor Password, you are authorized to set all items in the System Setup and to set [Password on boot]. In case other people also use the computer, it is recommended to set the User Password.

1. Reboot the system and press [F2] multiple times.



2. When the System Setup screen appears, go to [Security] > [Set Supervisor Password] using the arrow keys and press the [Enter] key.



3. When the Password Setting screen appears, enter a password and press the [Enter] key.

The password should not exceed 20 characters and should consist of English letters (A - Z), numbers (0 - 9), and special characters or a combination of them.



4. Enter the password once more and press the [Enter] key.



5. To save the changes in system setup, press [F10]. When a pop-up window appears, select [Yes] and press the [Enter] key.

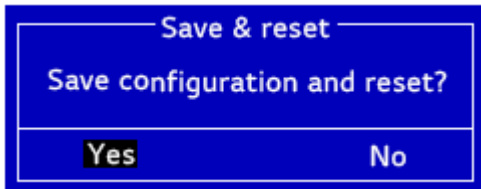

6. The PC will restart.

Setting the User Password

The User Password is lower than the Supervisor Password, so it can be entered only after setting the Supervisor Password.



Tip:

The User Password allows only limited access to the items that can be set compared to the Supervisor Password when using the System Setup.

1. Execute the System Setup screen, go to [Security] > [Set User Password] using the arrow keys and press the [Enter] key.

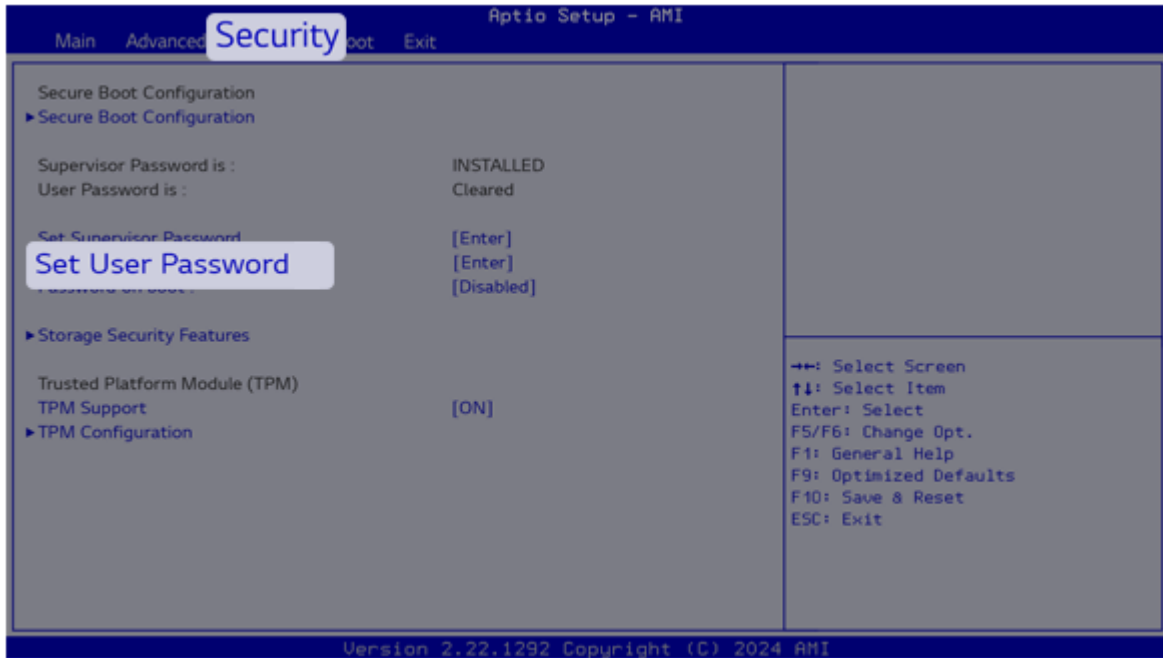

2. When the Password Setting screen appears, enter a password and press the [Enter] key.

The password should not exceed 20 characters and should consist of English letters (A - Z), numbers (0 - 9), and special characters or a combination of them.



3. Enter the password once more and press the [Enter] key.



4. To save the changes in system setup, press [F10]. When a pop-up window appears, select [Yes] and press the [Enter] key.

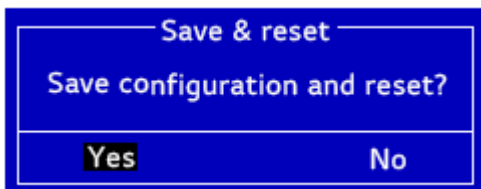

5. The PC will restart.

Password on boot

[Password on boot] protects your system by requiring during booting to enter the Supervisor Password or User Password.

To set [Password on boot], you first need to set the Supervisor Password or set both Supervisor and User Passwords.

1. Execute the System Setup screen, go to [Security] > [Password on boot] using the arrow keys and press the [Enter] key.



2. Select [Enabled] and press the [Enter] key to complete the [Password on boot] setting.

Setting the Storage Device Password

The Storage Device Password is to set a password in the storage device separate from the Supervisor Password.



Tip:

- Some storage devices may not support password setting.
- For the models equipped with two storage devices, you can set a password for each device. If passwords are set for both devices, the password input window appears twice during the booting process. The order in which the password input windows appears is according to the [Boot Type Order] of the [Boot] menu.



Caution:

If you lose the password for a storage device, you cannot recover the storage device.

- Please note that replacement of a storage device due to the loss of the password of the storage device is excluded from the product warranty.

1. Execute the System Setup screen, go to [Security] > [Storage Security Features] using the arrow keys and press the [Enter] key.

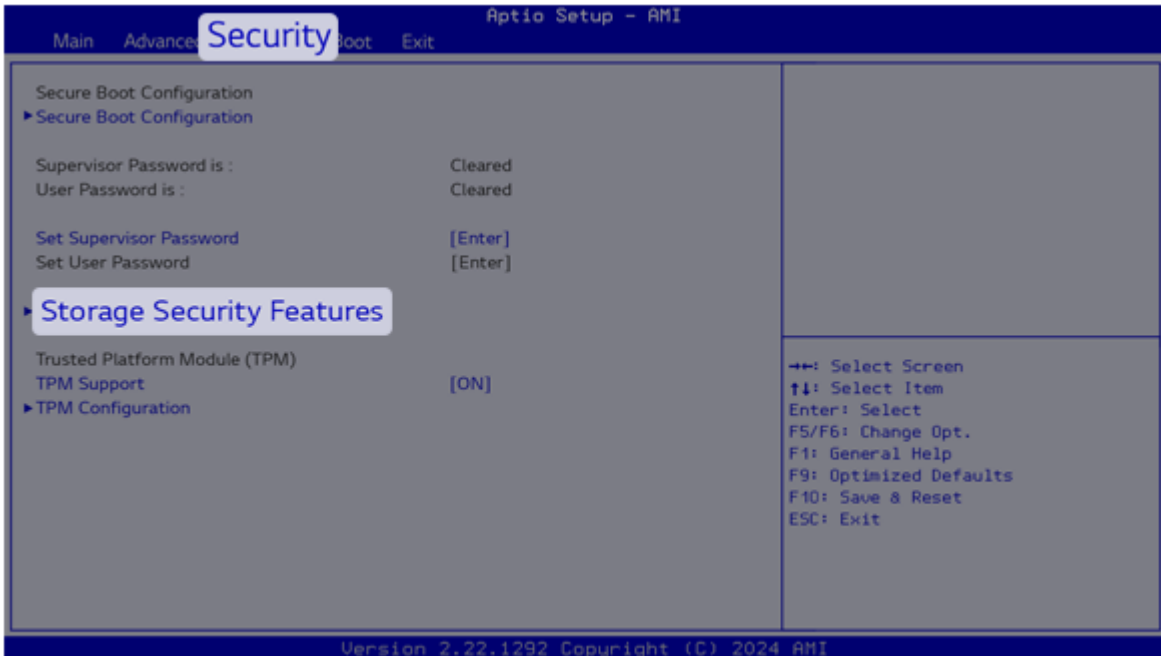

2. Go to the desired device and press the [Enter] key.



3. Press the [Enter] key in [Set Password].
4. When the Password Setting screen appears, enter a password and press the [Enter] key.
The password should not exceed 32 characters and should consist of English letters (A - Z), numbers (0 - 9), and special characters or a combination of them.



5. Enter the password once more and press the [Enter] key.



6. To save the changes in system setup, press [F10]. When a pop-up window appears, select [Yes] and press the [Enter] key.

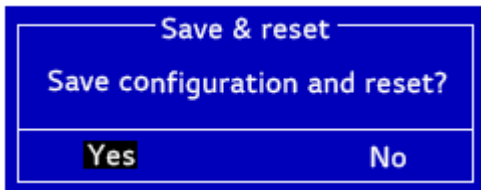

7. The PC will restart.

Installing the Driver

You can use LG Update & Renew to install the deleted drivers or the latest drivers easily and quickly.

1. Select the Start button [Windows logo] > [All] and run [LG Update & Renew].
2. Install a driver in the [Update] menu.

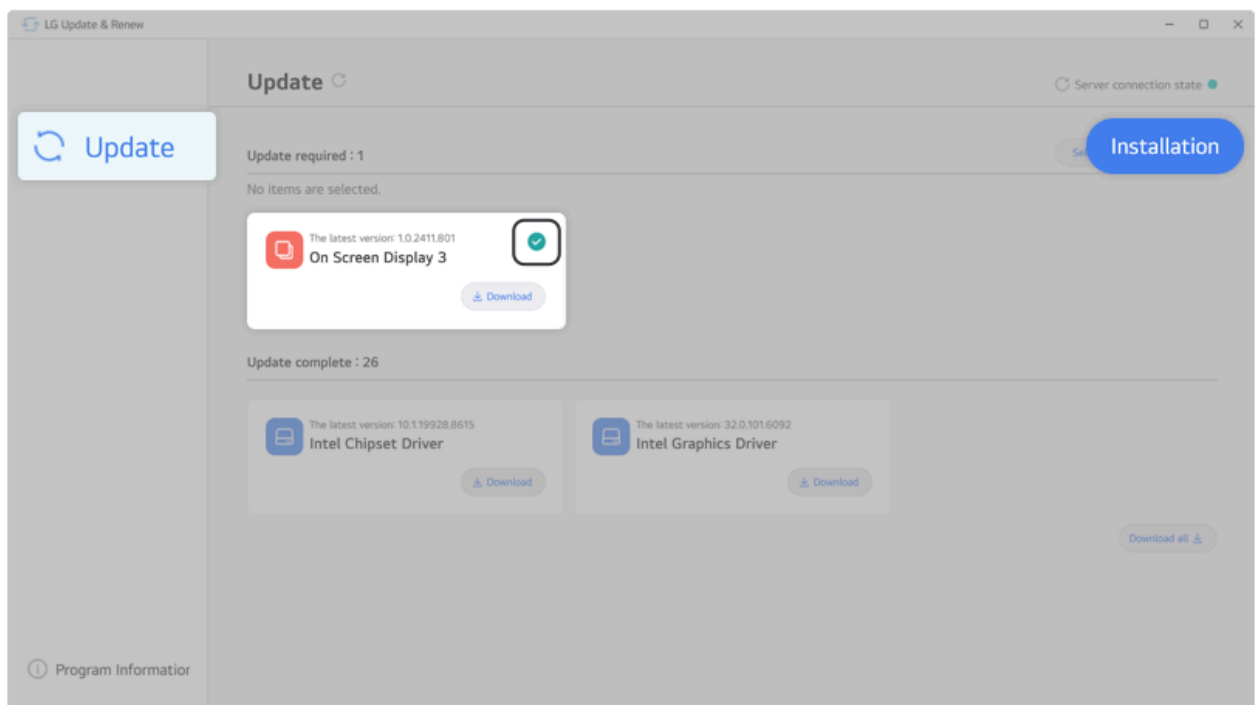

Tip:

Use LG Update & Renew to keep your system current and optimized.

The figures herein are subject to change without prior notice.

How to Download LG Update & Renew

You can download and install LG Update & Renew from LG Electronics website (www.lg.com).

Setting Auto Scaling

The Windows Auto Scaling feature for user's convenience may partially blur the screen or display some icons and texts larger.

Refer to the following information to change the DPI scaling to suit your needs.

1. Select the Start button [] > [Settings].



Tip:

Press the [] key or [Ctrl] + [Esc] on the keyboard to display the Start screen.

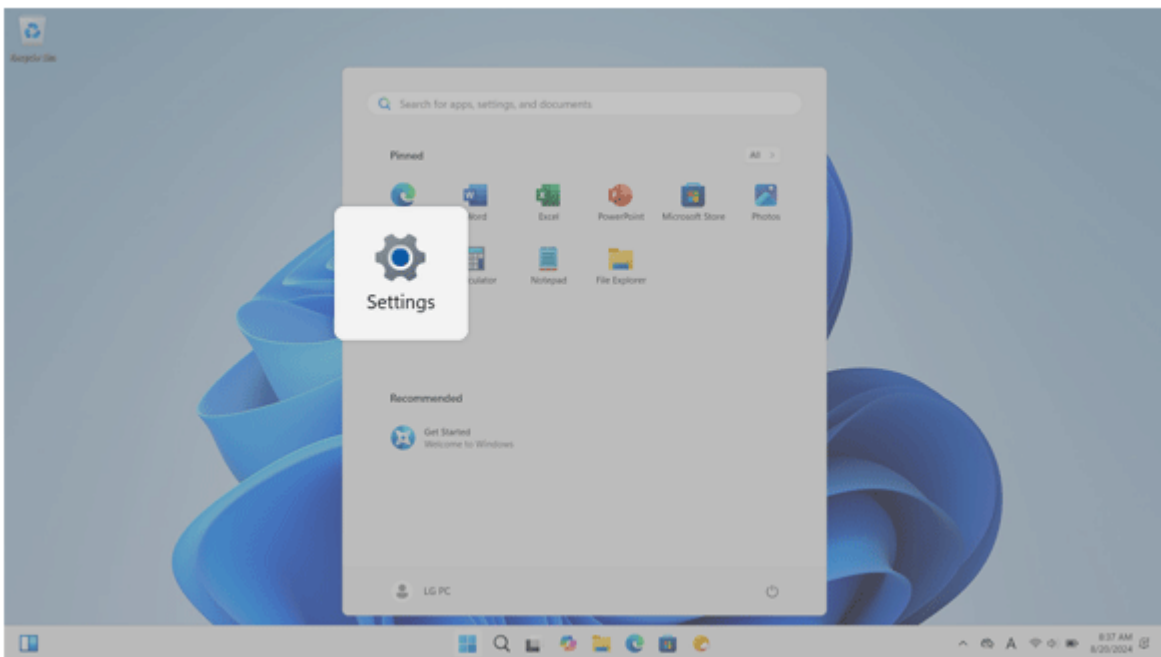

2. Select [System] > [Display].
3. Changing the [Scale] item value changes the auto scaling settings.

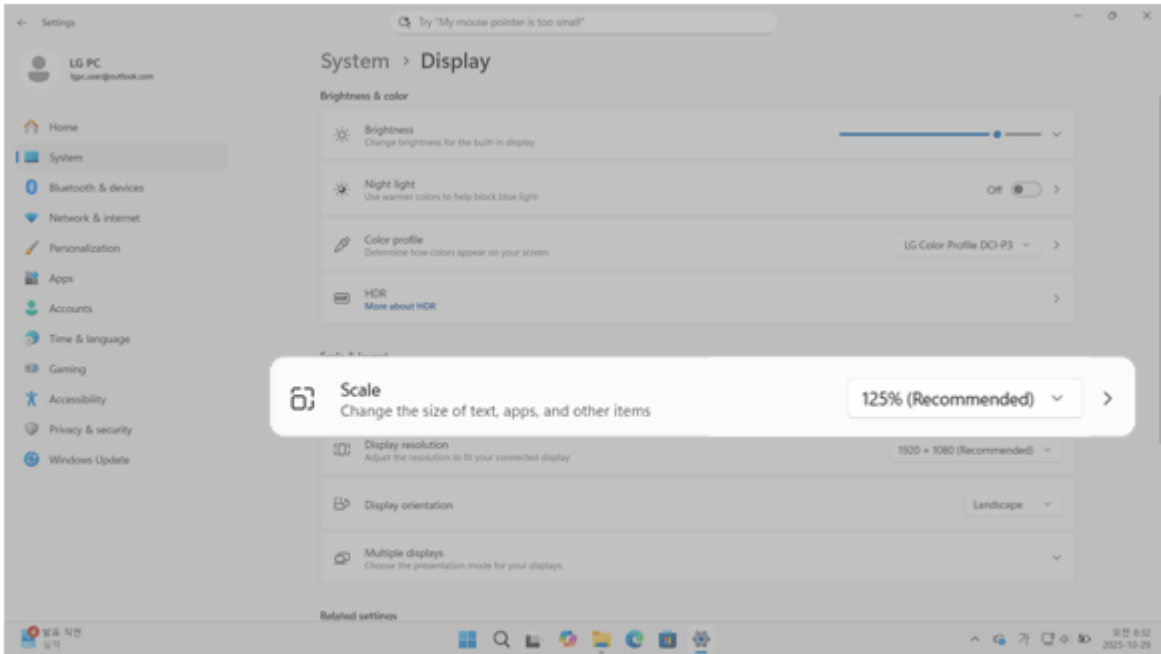

Tip:

After changing the Auto Scaling settings, some apps must be shut down and restarted for the scaling and layout to take effect.